

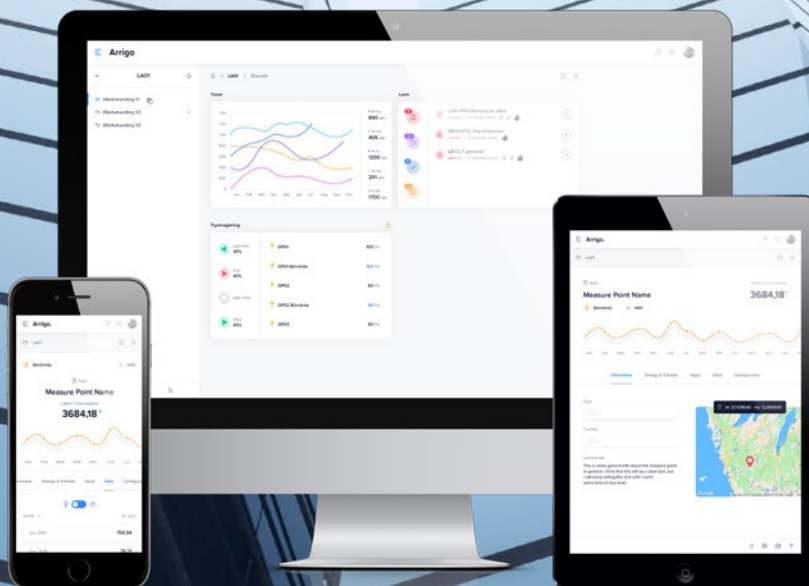

ARRIGO

EMS
BMS
FMS

FOR SMART
CONNECTED BUILDINGS
OF TOMORROW



Save time. Improve performance.
Optimize energy consumption.
Future-proof investment.

REGIN
THE CHALLENGER



ARRIGO

EMS
BMS
FMS





CONTENTS

INTRODUCTION	5
ARRIGO FOR BUILDING OWNERS	14
ARRIGO BMS <i>Building Management System</i>	16
ARRIGO EMS <i>Energy Management System</i>	18
ARRIGO FMS <i>Facility Management System</i>	19







ONE COMPREHENSIVE PLATFORM FOR EFFICIENT BUILDING MANAGEMENT.

THE SCALABLE PLATFORM ARRIGO covers all aspects of management for connected buildings. Arrigo provides building management (BMS), energy management (EMS), and facility management (FMS) in one powerful platform.

Arrigo comes with an interactive interface as standard. You will always have real-time access to relevant information allowing you to take instant action from any device. Whether you are a building owner, a facility managers or an integrator working with Regin's EXOscada today – Arrigo is the next step into the future generation of building management.



Monitor, control and optimize building performance.



Aggregate building data. Control and monitor your systems.



Plan operations and management. Get full control of documentation.



Save time. Improve performance.

Arrigo is designed to save time. Building management involves numerous processes and many different stakeholders. When everyone has real-time access and full control of their respective area of responsibility, the speed for completion of tasks will increase. Here is how Arrigo will make your business more efficient:

- ✓ One platform for collaboration improves productivity across the entire operation.
- ✓ Role-based and personalized views with widgets for fast and informed decisions.
- ✓ Real-time access to critical information enables analysis and instant actions.
- ✓ Easy access to maintenance data, day-to-day operations, and alarms.

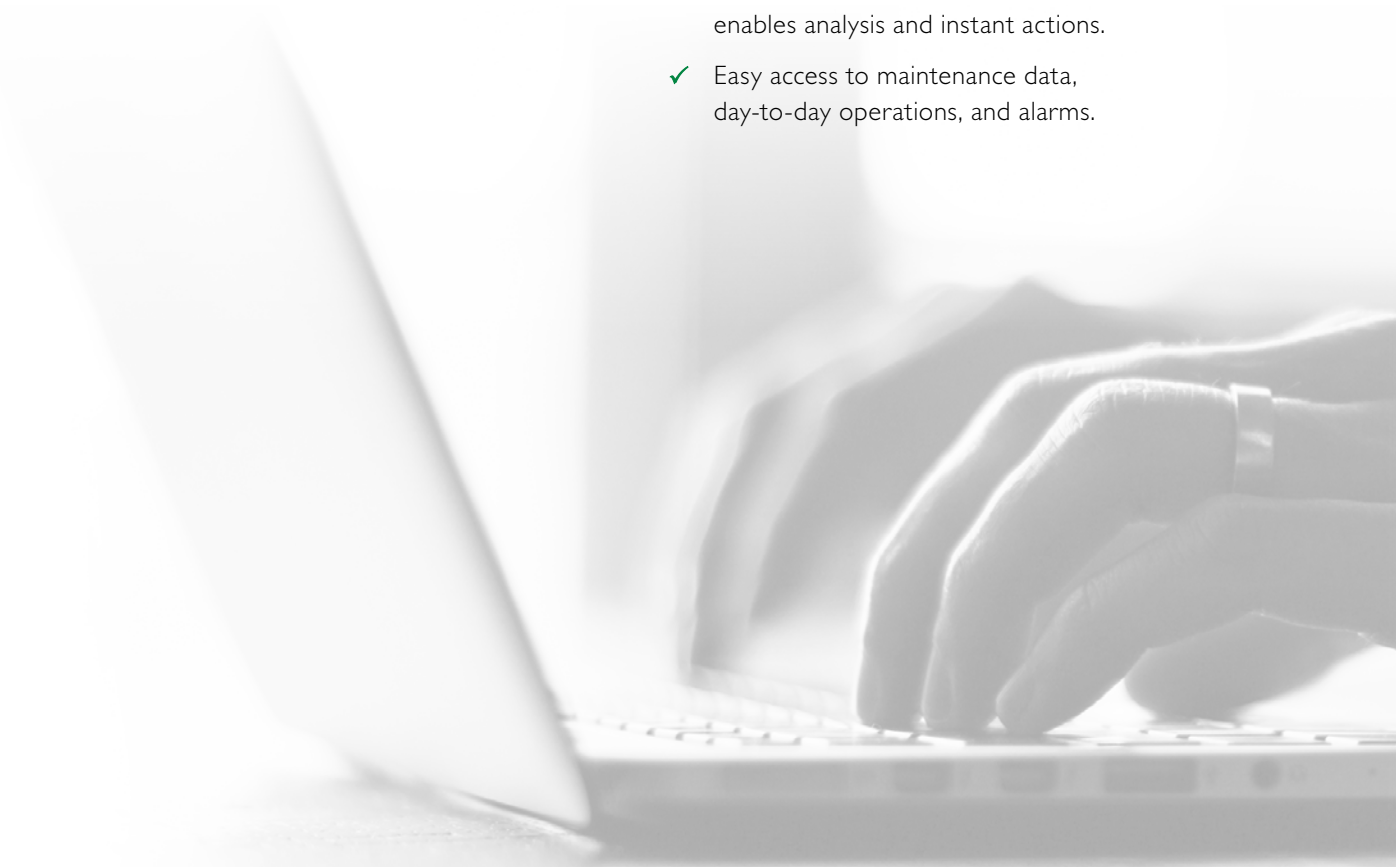

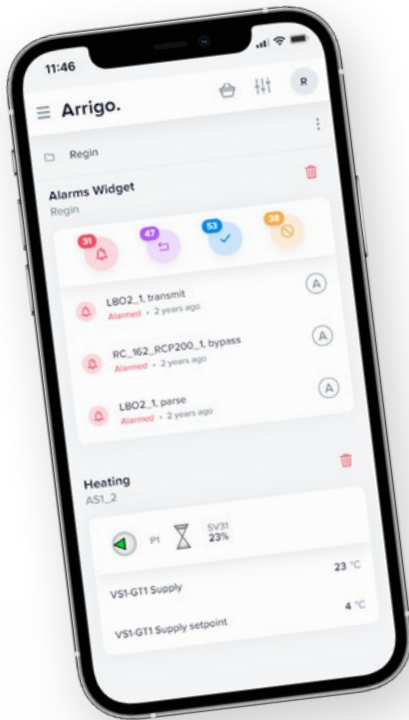

Optimize energy consumption.

Controlling energy consumption while ensuring indoor comfort and air-quality is one of the most critical challenges for building owners and facility managers. Arrigo provides an intuitive overview of the energy consumption in combination with indoor environment quality data through:

- ✓ Smart energy management tools (EMS) for data analysis, trends, comparisons, forecasts, follow-ups, and more.
- ✓ Visualized results in real-time reports provide the insights necessary for following up on actions and adjusting your system.
- ✓ Energy reports for key stakeholders or benchmarking (for instance through BREEAM, LEED, etc.) of your buildings' performance.

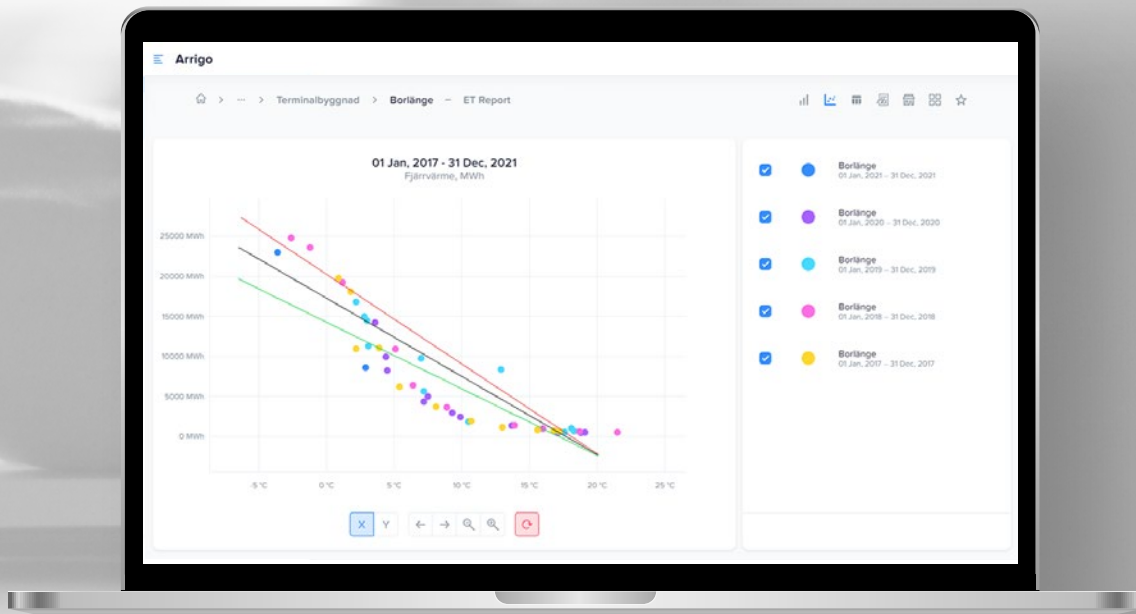



Future-proof investment.

While saving time and energy provides bottom-line financial arguments for investing in Arrigo, it does not end there. Lifecycle cost is also about taking a systematic approach to balancing maintenance, refurbishment and operating costs. Here's how Arrigo will help you maintain sustainable systems over time:

- ✓ Ensuring maximum lifespan for all our solutions during their lifecycle.
- ✓ Smooth upgrade from EXOscada. Reuse configurations and graphics.
- ✓ Implementing Arrigo with an existing Regin system will cut cost up to 90% in comparison with implementing a new system.
- ✓ Your Arrigo platform will work with the future generations of Regin controllers and field products.



ALWAYS IN CONTROL. ALWAYS READY.

Work from any device. Anytime. Anywhere.

Arrigo welcomes all users to an intuitive interface. Your working area adapts perfectly to any kind of role from facility managers too caretakers and energy consultants. Arrigo gives you quick access to critical parameters for easy configuration wherever you are. The interface supports your workflow no matter if you're working on a large monitor, a laptop, or a smart device.

Arrigo widgets. Little space, great benefits.

Arrigo widgets are smart, easy-to-use applications with a graphical interface that work with real-time data and offer valuable insights on the most important parameters. Some of the most commonly used widgets are alarms widgets and trend widgets. An Arrigo widget can consist of various components, such as text fields, tabbed panels, graphic animations, or interactive SVG animations.

*»Innovation through
time-saving design.«*

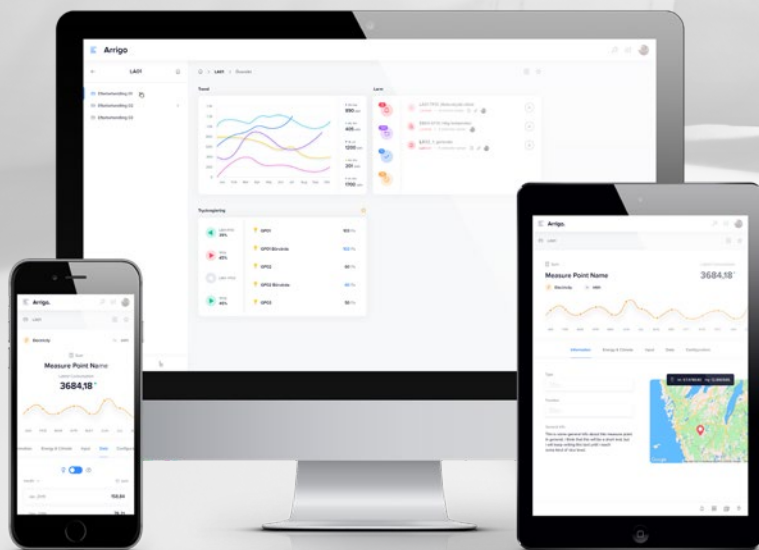

Arrigo Dashboards. Everything in one place. Always.

Arrigo dashboards can be compared to a homescreen where you'll find the most relevant widgets for your role in the workflow. The widgets provide real-time visibility into critical data and centralize all information in one place.

The dashboard is adapted to your specific business and provide data for both time and energy savings, on a daily basis. Dashboards are the primary bricks of a user interface. A set of navigable dashboards allows analysis and actions based on top-level executive statistics, as well as detailed application information.

Customized views. The way YOU like it.

When it comes to BMS-systems, every user has different routines. Some start their day by checking the alarm logs, others focus on energy consumption. Arrigo helps all platform users save time through customized views based on their most-used widgets. This way, every user starts Arrigo based on their version of a dashboard – just the way they want it. With instant, real-time access to relevant and viable information. Anytime. Anywhere.

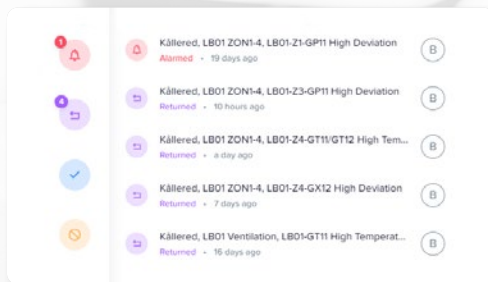

ALARMS



DYNAMIC



CHARTS

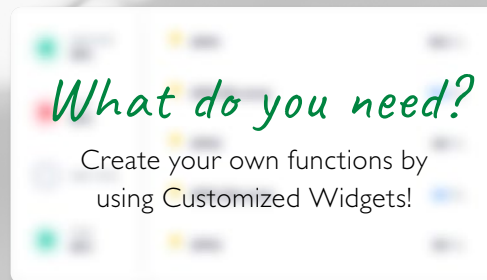

CUSTOMIZED WIDGETS



Empower efficient collaboration.

An intuitive user interface is the first step to improve employee experience. It allows maintenance teams to do their job efficiently, creating a positive environment where every role contributes to effective building performance. In Arrigo, everybody works with the same data. All data is visualized through personalized dashboards, smart widgets and powerful graphics through interactive SVG. The fluid responsive design by Arrigo makes it possible to use all system functionalities from any kind of device.

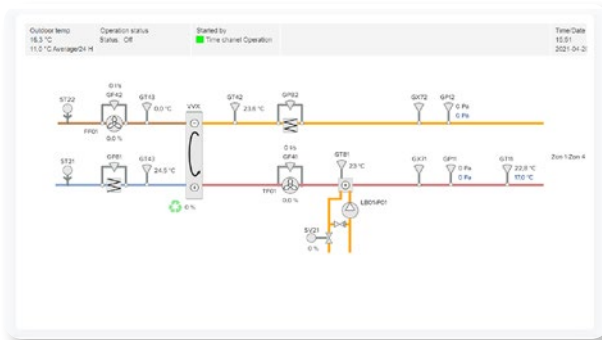

OPERATING TECHNICIAN

- Overview for control
- Fast way to alarms and support tickets
- Fast access to logged data

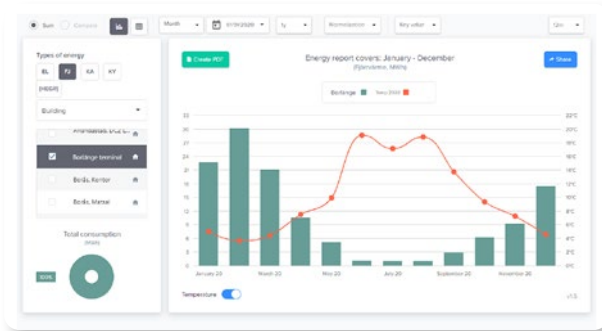

PROPERTY OWNER

- Overview of energy usage
- Lowered net operation cost over time
- Dedicated staff that want to make a difference

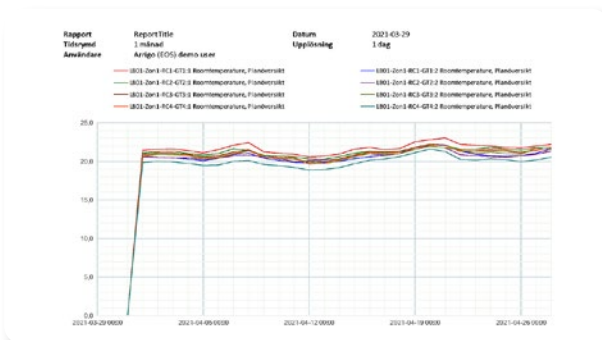

OPERATING MANAGER

- Knowing who's doing what
- Reports to management
- Overview of priorities



High performance buildings.

The scalable Arrigo platform meets all requirements for smart, connected and high-performing buildings. Arrigo consists of smart applications for building automation, energy monitoring, operation, and maintenance. Based on all the data collected in Arrigo, you as a property owner or manager can implement and follow up on your strategies. In addition, you can ensure a high level of comfort while minimizing energy use for heating, cooling, lighting, ventilation, etc.

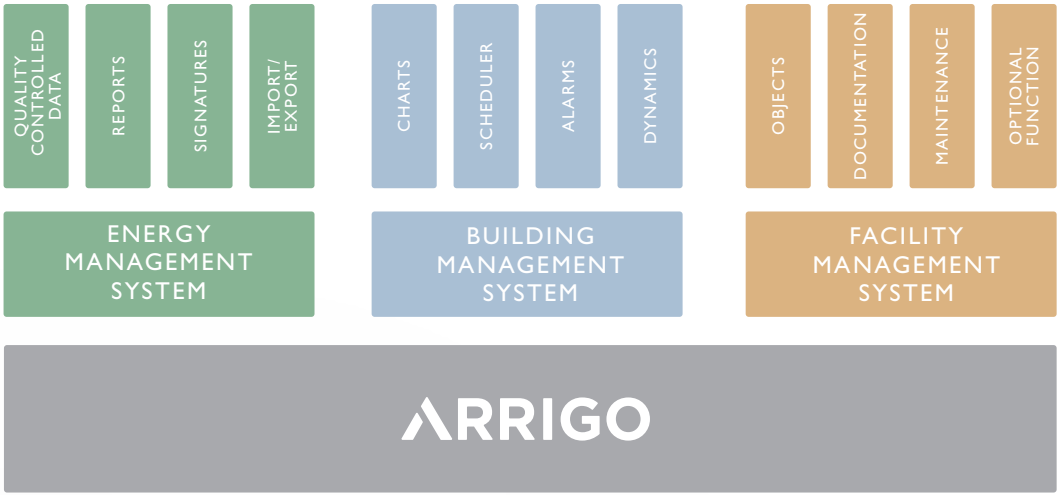

ARRIGO

FOR BUILDING OWNERS

Building owners and facility executives need to ensure safe and efficient processes for a productive indoor environment. This typically implies managing multiple systems, such as building management systems, energy optimization services, access control, etc. The building management platform Arrigo presents straightforward solutions to the five major challenges for building owners and facility managers.

1 Energy optimization.

Controlling costs while ensuring good indoor environments is probably one of the most critical challenges for any facility manager. Getting full control of building data from multiple sources to enable informed decisions is vital. Arrigo aggregates all data in one platform. You get access to powerful functions for in-depth analysis of your collected energy data. Analyze your costs, optimize performance and increase the property's cash flow and asset value.

2 Extending asset lifespan.

Arrigo is optimized to work seamlessly with Regin controllers and field products. This means that future versions of Arrigo are designed to ensure maximum backward compatibility with existing Regin systems. This way, you can feel assured that your installations are future-proofed for many years to come.



3 Manage outsourced services.

With everything connected in Arrigo, you can easily keep costs under control by monitoring your service providers. Import the data you want and connect the people you work with to Arrigo to keep track of tasks, costs, and services. Ensure they receive all tasks, notifications, and alarms directly from Arrigo.

4 Plan operation and maintenance.

Arrigo helps facility managers and building owners to plan and keep track of maintenance data and day-to-day operations. Arrigo delivers regular reports on the status of all monitored equipment and field products by providing:

- ✓ Fault statistics
- ✓ Operating time of specific components
- ✓ Alerts for preemptive maintenance and service

This gives users full control, enabling timely, informed decisions and corrective actions. This reduces costs and operational incidents while improving productivity across the entire operation.

5 Record keeping and data analysis.

Typically, facility managers and building owners are often overwhelmed with records from day-to-day operations to minutes of meetings, stock inventory, repairs and services.

Arrigo helps you meet this challenge with efficient tools for:

- ✓ Planned maintenance
- ✓ Error reports
- ✓ Damage reports
- ✓ Government inspection reports
- ✓ Service requests
- ✓ Document management
- ✓ Journals
- ✓ And much more...

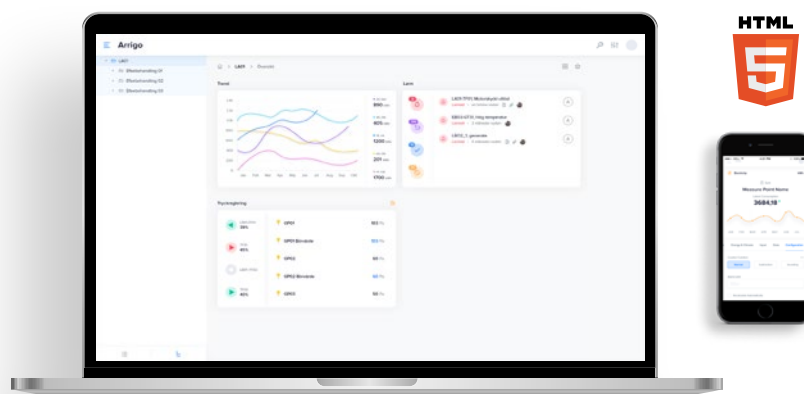

ARRIGO

BUILDING MANAGEMENT SYSTEM

The scalable HMI/SCADA application, Arrigo BMS, strengthens the capacity for Regin system integrators and property owners. With an HTML5-based, future-proof technology, you save time on integration, operation, and maintenance. With Arrigo BMS you can monitor, visualize and analyze all levels of your Regin system from your computer, tablet or mobile phone.

Arrigo BMS is compatible with all previous solutions from Regin. Regardless of the control system, it is easy to switch from an existing system to Arrigo BMS and Secure a Building Management System of the future.

All your data. In one platform.

Arrigo is an efficient tool for integrators who want to provide their customers with outstanding user experience and add-value services. The Arrigo BMS application aggregates data from all your Regin systems and subsystems, including IT systems, hotel booking systems, cloud services, etc. Data is consumed through an intuitive and responsive interface based on dashboards and smart widgets. A shared source of data for building owners, caretakers, and system integrators enables effective collaboration, swift decision making, and instant follow-up on implemented actions.



A selection of functions in Arrigo BMS.

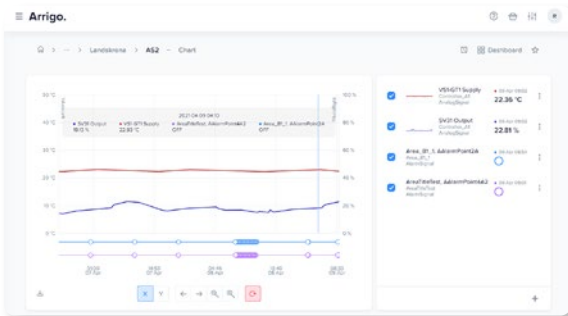

Charts, data logging and real-time trends.

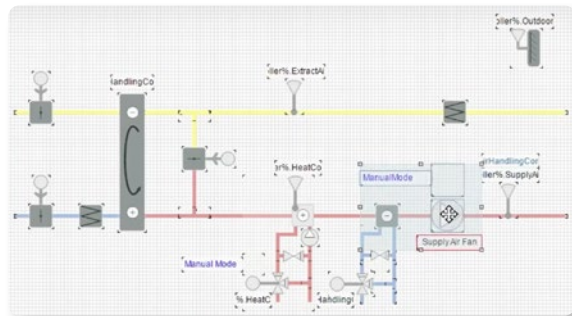

Create dynamic front-end graphics and visualize real-time building processes.

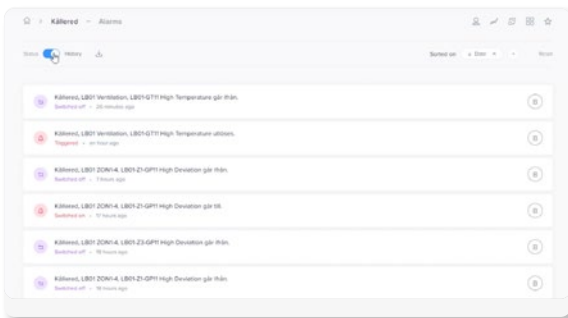

Full alarm handling.

```
$url = "https://services.regin.se/ci/arrigo/api/login"

$headers = @{
    "Content-Type" = "application/json"
}

$body = @{
    "username": "user",
    "password": "password"
}

$loginResponse = Invoke-WebRequest -Uri $url -Method POST -Body $body -Headers $headers
Write-Host $loginResponse.authToken
```

Arrigo API. Unlock the full potential of building data.



“On several of our clients' sites, we have Regin components from the early 1990s installed. Today, they are all connected to Arrigo. For us, maintaining these products is not only a matter of saving costs. It is a matter of sustainability.

Bjarne Johansson, Systeminstallation, Sweden



ENERGY MANAGEMENT SYSTEM

Arrigo EMS is the application for energy management that integrates seamlessly with Arrigo BMS. With the EMS-module in place, you can perform in-depth analysis of your collected property data and generate massive energy savings in individual buildings or groups of buildings.

Full control of energy consumption.

Arrigo gives property owners and managers complete control of their energy consumption. Use the power of property data from the Arrigo BMS application and combine it with in-depth analysis from Arrigo EMS to achieve sustainable savings. Take control of your costs, optimize property performance and increase the property's cash flow and asset value.

Visualize results.

A prerequisite for saving energy in real estate is to understand the origin of costs. Arrigo EMS provides you a suite of simple tools that quickly deliver the insights needed for optimized building performance. At all times.

Arrigo EMS provides:

- ✓ Comparisons of energy use before and after implemented improvements.
- ✓ Functions for comparisons of buildings.
- ✓ Normalized values with corrections for outside temperature variations.
- ✓ Smart forecasting features showing how adjustments will affect energy use over time.
- ✓ Quality-assured reports.
- ✓ Features such as real-time report sharing with different stakeholders.
- ✓ Filtered views on geographical areas, residential areas, and properties.
- ✓ Customized choice of level of data presentation.
- ✓ And much more...

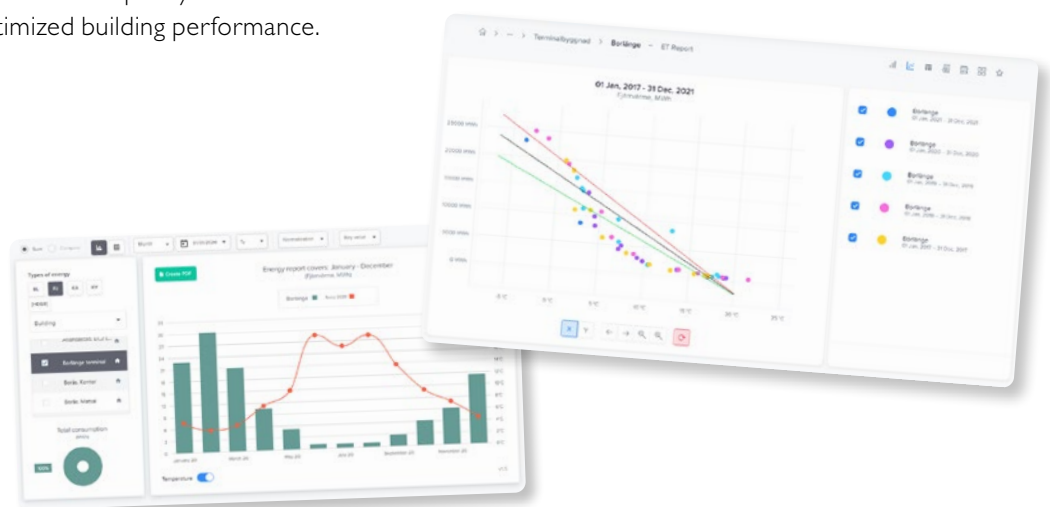

ARRIGO

FACILITY MANAGEMENT SYSTEM

Arrigo FMS is an application that helps organizations increase efficiency in the planning and execution of their facility processes.

Easy and effective facility maintenance.

Arrigo FMS is an application that helps facility managers to make sure that indoor environments are safe, comfortable, productive, and sustainable.

Arrigo FMS provides efficient tools for:

- ✓ Planned maintenance
- ✓ Error reports
- ✓ Damage reports
- ✓ Compliance reports
- ✓ Environmental assessments
- ✓ Service requests
- ✓ Document management
- ✓ Journals
- ✓ And much more...





TECHNOLOGY FOR A SUSTAINABLE FUTURE.

Arrigo leads digitalization in buildings by connecting existing Regin systems and products with third-party systems and services.

With efficient analysis tools, Arrigo empowers professionals. Arrigo helps the users to understand the level of usage, and how building functions can be optimized for the best user experience with the lowest energy consumption.

Implementing Arrigo is a highly profitable investment opportunity that goes far beyond financial returns. Arrigo contributes to health, well-being, and productivity in buildings while minimizing energy consumption and carbon dioxide emissions.



AB Regin, Box 116, SE-428 22 Källered., Sweden • Visiting adress: Bangårdsvägen 35
Phone: +46 (0) 31 720 02 00 • info@regincontrols.com • www.regincontrols.com