

WE TAKE BUILDING
AUTOMATION PERSONALLY

en

MANUAL
REGIOsmEEDO





THANK YOU FOR CHOOSING REGIN!

Ever since Regin was established in 1947, we have developed and marketed products and systems that create good levels of indoor comfort. Today, we are an important player with one of the market's broadest ranges for building automation.

Our goal is to make real estates in the world more energy efficient. Regin is an international group and our products sells in over 90 countries. Thanks to our global presence with strong local representation, we are well aware of the requirements of the market, as well as of how our products and systems function under the most variable conditions. Every year, Regin makes substantial investments in the development of our systems and HVAC-products.

DISCLAIMER

The information in this manual has been carefully checked and is believed to be correct. Regin makes no warranties about the contents of this manual and users are requested to report errors and discrepancies to Regin, so that corrections may be made in future editions. The information in this document is subject to change without prior notification.

Some product names mentioned in this document are used for identification purposes only and may be the registered trademarks of their respective companies.

© AB Regin. All rights reserved.

Rev. G, 2023-09-19

1	Introduction.....	5
1.1	About this manual.....	5
1.2	Software version	6
2	Control functions.....	7
2.1	Controller mode	7
2.1.1	Heating.....	7
2.1.2	Heating + Heating	8
2.1.3	Heating + Cooling	9
2.1.4	Cooling.....	10
2.1.5	Heating/Cooling (change-over)	11
2.1.6	Heating + Heating/Cooling (change-over).....	13
2.1.7	Heating + VAV	15
2.1.8	Cooling + VAV	16
2.1.9	VAV	18
2.1.10	Heating + Cooling + VAV	18
2.2	Maximum and minimum limits for heating and cooling output.....	20
2.3	Change-over	21
2.3.1	Change-over detection	22
2.4	Controller state.....	23
2.4.1	Control behaviour	24
2.4.2	Configuration settings	26
2.4.3	State changes.....	27
2.5	Fan control	30
2.5.1	EC fan control	31
2.5.2	3-speed fan control	33
2.5.3	Fan boost	35
2.5.4	Fan kick-start.....	37
2.5.5	Fan afterblow	38
2.6	VAV control.....	38
2.7	Forced ventilation	41
2.8	Presence detection	44
2.9	Communication heartbeat	46
2.10	CO ₂ control.....	47
2.11	Extra zone control.....	48
3	Room unit.....	50
3.1	Model overview and user interface description	50
3.2	Room units without display	52
3.2.1	Selecting a fan speed	52
3.2.2	Performing a setpoint adjustment	52
3.2.3	Putting the room HVAC system in a comfort/energy saving mode or increasing the airflow	52
3.2.4	LED indications.....	52
3.3	Room units with display	53
3.3.1	Selecting a fan speed	53
3.3.2	Performing a setpoint adjustment	53
3.3.3	Putting the room HVAC system in a comfort/energy saving mode or increasing the airflow	54
3.3.4	Display indications.....	54
3.3.5	Basic controller configuration via the display	56
3.3.6	Parameter menu access.....	56
3.3.7	Display background lighting.....	56
3.3.8	ED-RU-DOS functions	57
3.4	Communication LED	57
3.5	Enable or disable buttons/switch and knob	57
3.6	Wiring	58
3.7	Configuration settings.....	58

Table of Contents

3.7.1	General.....	58
3.7.2	Max setpoint adjustment	58
3.7.3	Display and buttons	59
4	Inputs / Outputs.....	60
4.1	General configuration.....	60
4.2	Input control	62
4.3	Output control	62
5	Setpoint	64
5.1	Active setpoint	64
5.2	Setpoint adjustment	65
6	Controller connections and wiring diagrams	66
7	LED status indications	70
8	Mounting	71
8.1	DIN rail mounting inside a cabinet.....	71
8.2	Wall Mounting	71
9	Maintenance and service.....	74
9.1	Changing the battery	74
9.2	Changing the fuse	74
9.3	Resetting the application memory.....	75
Appendix A	Technical data.....	76
A.1	General data	76
A.2	Inputs	76
A.3	Outputs	76
A.4	RS485 communication port 1.....	77
A.5	RS485 communication port 2.....	77
A.6	Ethernet communication port	77
Appendix B	Room unit display parameter lists.....	78
B.1	CTRL	78
B.2	SYS	79
B.3	ACTR.....	80
B.4	FAN	81
B.5	M/AT	81
B.6	HMI	82
B.7	IO	83
B.8	ALAM.....	85
Appendix C	Modbus signal lists.....	87
C.1	Coil status registers	87
C.2	Input registers.....	89
C.3	Holding registers	91
C.4	Input status registers.....	101
Appendix D	BACnet signal lists.....	104
D.1	Multistate values	104
D.2	Binary values	107
D.3	Analog values	110

I Introduction

Regio^{Eedo} is a 230 V AC room controller with a pre-programmed software application for fan coils. The controller provides built-in communication via EXOline, Modbus, or BACnet for integration in EXOscada or other SCADA systems. The controller is fast and easy to configure and commission using Regin's free Application tool software, and it connects seamlessly to the room units in Regin's ED-RU... series. The controller is installed in a ceiling void by using a baseplate with terminal protection covers, or on a DIN rail inside a cabinet.

I.1 About this manual

This manual provides descriptions of the Regio^{Eedo} controller functions, as well as hardware-related information concerning controller connections, wiring, mounting, maintenance and service, and so on.

Regio^{Eedo} is configured and commissioned by using Regin's Application tool software. The controller functions and their configuration options are therefore described in an Application tool context.

The manual has the following high-level section structure:

- ✓ Sections 2-5 contain descriptions of and configuration information for controller functions, such as:
 - ✓ Heating, cooling, and variable air volume (VAV) controller modes
 - ✓ Controller states
 - ✓ Fan control
 - ✓ CO₂ control
 - ✓ Presence detection
 - ✓ Change-over
- ✓ Sections 6-9 contain hardware-related information topics, such as:
 - ✓ Controller connections and wiring diagrams
 - ✓ LED status indications
 - ✓ Mounting
 - ✓ Maintenance and service
- ✓ The Appendix sections contain the following information:
 - ✓ Technical data
 - ✓ Room unit display parameter lists
 - ✓ Modbus signal lists
 - ✓ BACnet signal lists

Special text formats used in the manual:



Note! This box and symbol is used to show useful tips and tricks.



Caution! This type of text and symbol is used to show cautions.



Warning! This type of text and symbol is used to show warnings.

1.2 Software version

This manual is valid for software version 2.0-1-01 or later. The latest software version can be downloaded via www.regincontrols.com.

2 Control functions

This section contains descriptions of and configuration information for the controller's basic control functions.

2.1 Controller mode

The controller mode function enables the controller to support control of various room HVAC systems, that is, different combinations of heating, cooling, and variable air volume (VAV) devices that are part of a room.

The controller provides the following 10 selectable controller modes:

- ✓ Heating
- ✓ Heating + Heating
- ✓ Heating + Cooling
- ✓ Cooling
- ✓ Heating/Cooling (change-over)
- ✓ Heating + Heating/Cooling (change-over)
- ✓ Heating + VAV
- ✓ Cooling + VAV
- ✓ VAV
- ✓ Heating + Cooling + VAV

Based on the selected controller mode, the controller outputs one or multiple control signal sequences, denoted Y1, Y2, and Y3. The signal sequences control the heating, cooling, and VAV devices in the room, and are assigned to the different controller outputs via configuration.

Figure 2-1 shows the drop down that is used to select a controller mode in Application tool.

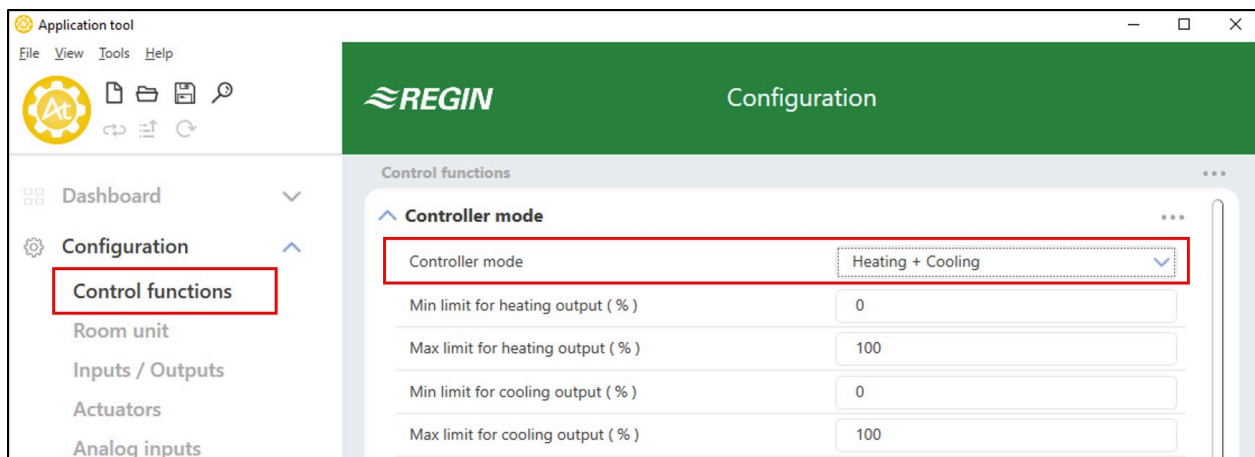

Figure 2-1 Controller mode selection in Application tool.

2.1.1 Heating

This controller mode is suitable for room HVAC systems that use a radiator or fan coil as heating device.

The controller acts as a heating controller and regulates based on the heating setpoint and the current room temperature.

The controller is always in heating mode and outputs a heating signal, Y1, that is configured on the controller outputs by using the configuration values listed in *Table 2-1*.

Maximum and minimum limits for the output signal can be set, see section 2.2.

Table 2-1 Controller output configuration values and controller output types.

Output signal	Controller output configuration value	Controller output type
Y1	Heating	Analog
	Heating valve, increase	Digital
	Heating valve, decrease	Digital
	Heating valve, thermal (PWM)	Digital

Figure 2-2 illustrates the control behaviour for this controller mode when no maximum or minimum limits are set.

The heating demand increases as the room temperature falls. When the room temperature falls below the heating setpoint, Y1: Heating signal increases to respond to the heating demand. At 100% heating demand, Y1: Heating signal reaches its maximum.

When the room temperature is higher than the heating setpoint and no heating demand exists, Y1: Heating signal is at its minimum.

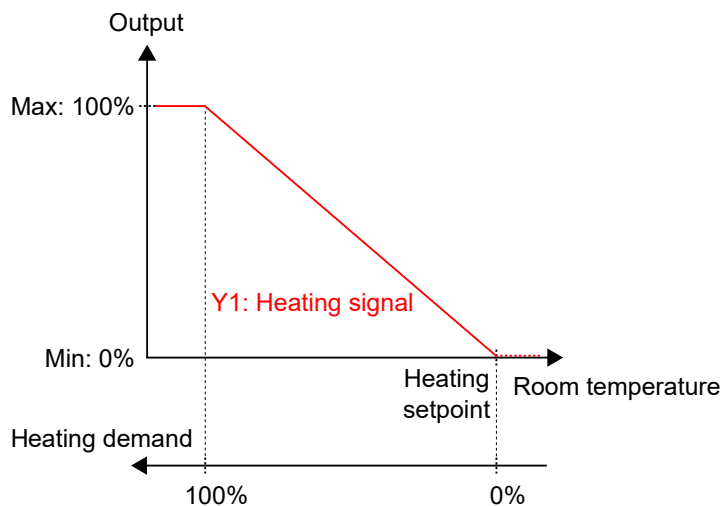

Figure 2-2 Control behaviour for the Heating controller mode.

2.1.2 Heating + Heating

This controller mode is suitable for room HVAC systems that use a combination of two heating devices in sequence, such as radiators or fan coils.

The controller acts as a heating controller and regulates based on the heating setpoint and the current room temperature.

The controller is always in heating mode and outputs two heating signals, Y1 and Y2, in sequence that are configured on the controller outputs by using the configuration values listed in *Table 2-2*.

The Y1 and Y2 signal sequence order is configurable.

Maximum and minimum limits for the output signals can be set, see section 2.2.

Table 2-2 Controller output configuration values and controller output types.

Output signal	Controller output configuration value	Controller output type
Y1	Heating	Analog
	Heating valve, increase Heating valve, decrease	Digital Digital
	Heating valve, thermal (PWM)	Digital
Y2	Heating 2	Analog
	Heating valve 2, increase Heating valve 2, decrease	Digital Digital
	Heating valve 2, thermal (PWM)	Digital

Figure 2-3 illustrates the control behaviour for this controller mode when no maximum or minimum limits are set.

The heating demand increases as the room temperature falls. When the room temperature falls below the heating setpoint, Y1: Heating signal increases to respond to the heating demand. At 49% heating demand, Y1: Heating signal reaches its maximum. When the room temperature falls further and the heating demand exceeds 51%, Y2: Heating 2 signal increases while Y1: Heating signal stays at its maximum. At 100% heating demand, Y2: Heating 2 signal reaches its maximum.

When the room temperature is higher than the heating setpoint and no heating demand exists, both Y1: Heating signal and Y2: Heating 2 signal are at their minimum.

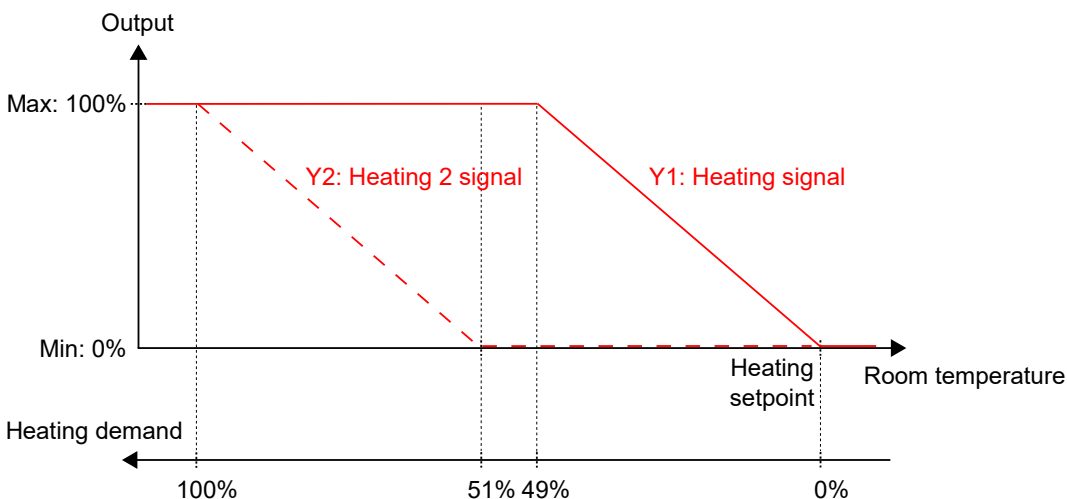

Figure 2-3 Control behaviour for the Heating + Heating controller mode.

2.1.3 Heating + Cooling

This controller mode is suitable for room HVAC systems that use a radiator or fan coil as heating device, and a fan coil or chilled beam as cooling device.

The controller acts as a heating and cooling controller and regulates based on the heating setpoint, cooling setpoint, and the current room temperature.

The temperature range between the heating and cooling setpoints is defined as the deadband. The controller is in heating mode when the room temperature is lower than [heating setpoint plus half the deadband], and in cooling mode when the room temperature is higher than [cooling setpoint minus half the deadband].

When in heating mode, the controller outputs a heating signal, Y1, that is configured on the controller outputs by using the values listed in Table 2-3.

When in cooling mode, the controller outputs a cooling signal, Y2, that is configured on the controller outputs by using the values listed in *Table 2-3*.

Maximum and minimum limits for the output signals can be set, see section 2.2.

Table 2-3 Controller output configuration values and controller output types.

Output signal	Controller output configuration value	Controller output type
Y1	Heating	Analog
	Heating valve, increase Heating valve, decrease	Digital Digital
	Heating valve, thermal (PWM)	Digital
Y2	Cooling	Analog
	Cooling valve, increase Cooling valve, decrease	Digital Digital
	Cooling valve, thermal (PWM)	Digital
Y1 + Y2	6-way valve	Analog
	6-way valve, increase 6-way valve, decrease	Digital Digital

Figure 2-4 illustrates the control behaviour for this controller mode when no maximum or minimum limits are set.

The heating demand increases as the room temperature falls. When the room temperature falls below the heating setpoint, Y1: *Heating signal* increases to respond to the heating demand. At 100% heating demand, Y1: *Heating signal* reaches its maximum. When the room temperature is in the range between the heating setpoint and the deadband centre, and no heating demand exists, Y1: *Heating signal* is at its minimum.

The cooling demand increases as the room temperature rises. When the room temperature rises above the cooling setpoint, Y2: *Cooling signal* increases to respond to the cooling demand. At 100% cooling demand, Y2: *Cooling signal* reaches its maximum. When the room temperature is in the range between the cooling setpoint and the deadband centre, and no cooling demand exists, Y2: *Cooling signal* is at its minimum.

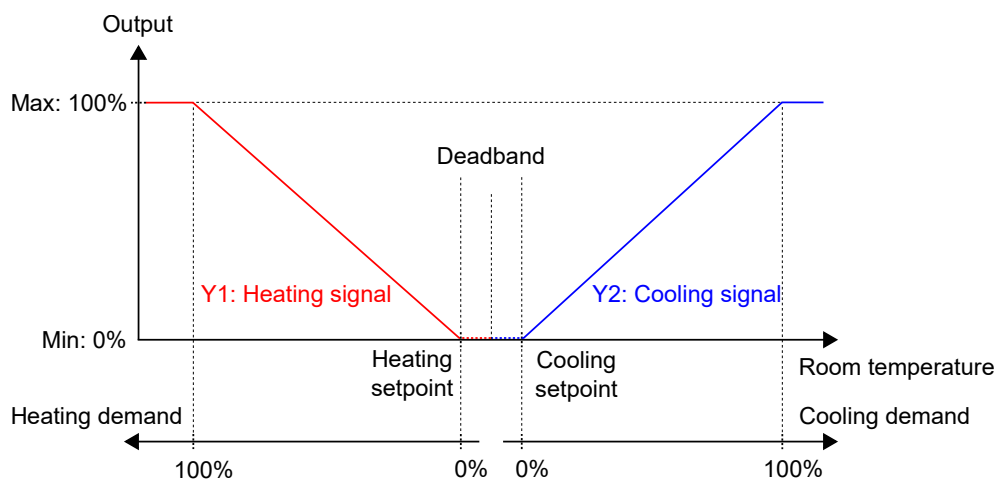

Figure 2-4 Control behaviour for the Heating + Cooling controller mode.

2.1.4 Cooling

This controller mode is suitable for room HVAC systems that use a fan coil or a chilled beam as cooling device.

The controller acts as a cooling controller and regulates based on the cooling setpoint and the current room temperature.

The controller is always in cooling mode and outputs a cooling signal, Y1, that is configured on the controller outputs by using the configuration values listed in *Table 2-4*.

Maximum and minimum limits for the output signal can be set, see section 2.2.

Table 2-4 Controller output configuration values and controller output types.

Output signal	Controller output configuration value	Controller output type
Y1	Cooling	Analog
	Cooling valve, increase	Digital
	Cooling valve, decrease	Digital
	Cooling valve, thermal (PWM)	Digital

Figure 2-5 illustrates the control behaviour for this controller mode when no maximum or minimum limits are set.

The cooling demand increases as the room temperature rises. When the room temperature rises above the cooling setpoint, Y1: Cooling signal increases to respond to the cooling demand. At 100% cooling demand, Y1: Cooling signal reaches its maximum.

When the room temperature is lower than the cooling setpoint and no cooling demand exists, Y1: Cooling signal is at its minimum.

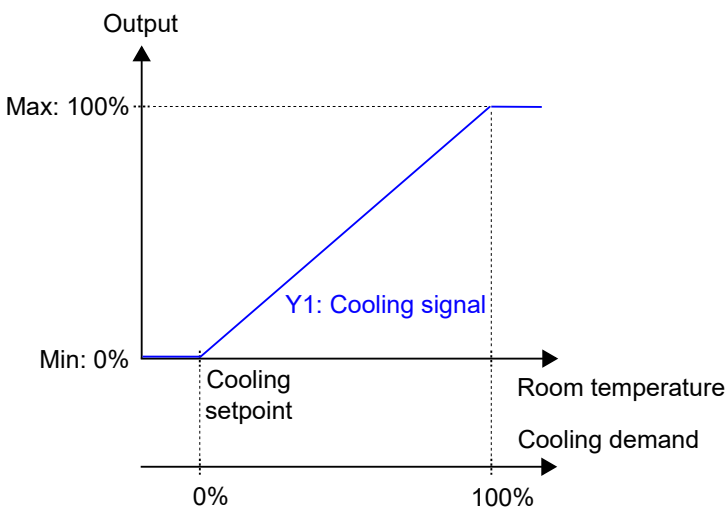

Figure 2-5 Control behaviour for the Cooling controller mode.

2.1.5 Heating/Cooling (change-over)

This controller mode is suitable for room HVAC systems that use a 2-pipe fan coil as heating and cooling device. The change-over function makes it possible to use the controller in a 2-pipe change-over system, where warm or cold media flow in the same pipes and one valve is used to regulate both heating and cooling distribution. See section 2.3 for information about the change-over function.

The controller acts as a heating or cooling controller and regulates based on the heating setpoint, cooling setpoint, and the current room temperature.

The controller is either in heating or cooling mode, and switches between the modes according to its current change-over state, see section 2.3.

When the controller is in heating or cooling mode, the controller outputs a heating or cooling signal, Y1, that is configured on the controller outputs by using the configuration values listed in *Table 2-5*.

Maximum and minimum limits for the output signal can be set, see section 2.2.

Table 2-5 Controller output configuration values and controller output types.

Output signal	Controller output configuration value	Controller output type
Y1	Change-over valve	Analog
	Change-over valve, increase	Digital
	Change-over valve, decrease	Digital
	Change-over valve, thermal (PWM)	Digital

Figure 2-6 illustrates the control behaviour in heating mode, and when no maximum or minimum limits are set.

The heating demand increases as the room temperature falls. When the room temperature falls below the heating setpoint, Y1: Change-over (heating mode) signal increases to respond to the heating demand. At 100% heating demand, Y1: Change-over (heating mode) signal reaches its maximum.

When the room temperature is higher than the heating setpoint and no heating demand exists, Y1: Change-over (heating mode) signal is at its minimum.

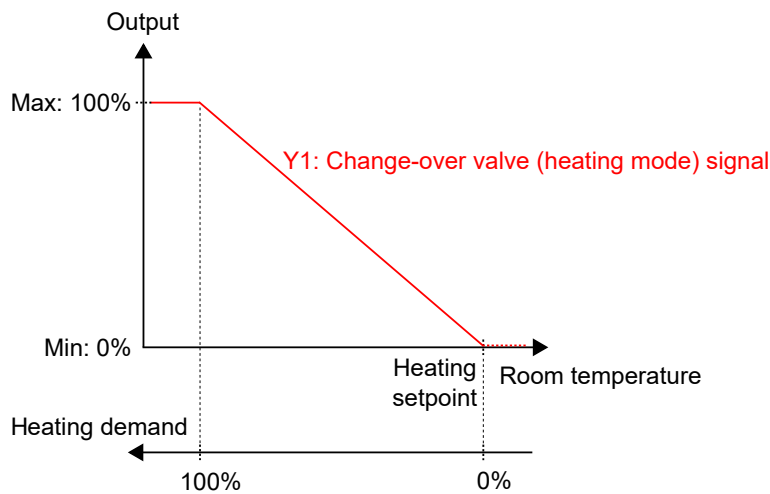

Figure 2-6 Control behaviour for the Heating/Cooling (change-over) controller mode when the controller is in heating mode.

Figure 2-7 illustrates the control behaviour in cooling mode, and when no maximum or minimum limits are set.

The cooling demand increases as the room temperature rises. When the room temperature rises above the cooling setpoint, Y1: Change-over (cooling mode) signal increases to respond to the cooling demand. At 100% cooling demand, Y1: Change-over (cooling mode) signal reaches its maximum.

When the room temperature is lower than the cooling setpoint and no cooling demand exists, Y1: Change-over (cooling mode) signal is at its minimum.

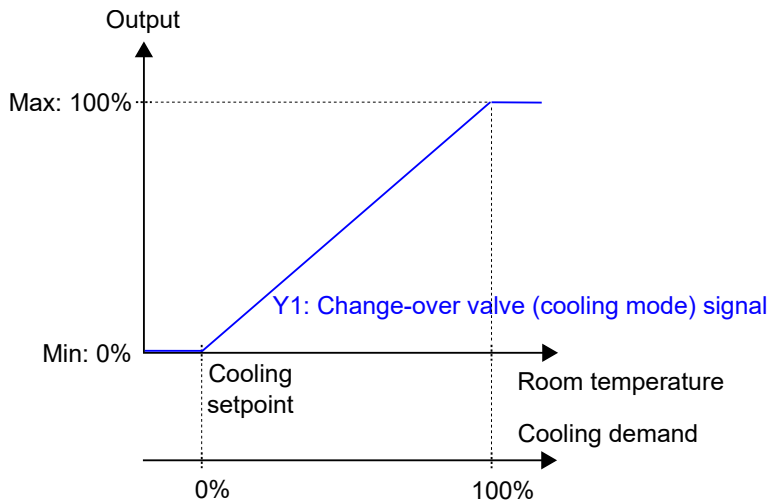

Figure 2-7 Control behaviour for the Heating/Cooling (change-over) controller mode when the controller is in cooling mode.

2.1.6 Heating + Heating/Cooling (change-over)

This controller mode is suitable for room HVAC systems that use a 2-pipe fan coil as heating and cooling device, and where an additional heating device, typically an electrical heating battery, is used to provide extra heating during cold seasons.

The controller is set to operate in either Heating + Heating mode or Heating + Cooling mode by using the change-over function. The change-over function makes it possible to use the controller in a 2-pipe change-over system, where warm or cold media flow in the same pipes and one valve is used to regulate both heating and cooling distribution. See section 2.3 for information about the change-over function.

The controller operates in Heating + Heating mode when the controller change-over state is *heating*, and in Heating + Cooling mode when the controller change-over state is *cooling*. See section 2.3 for information about the controller change-over state.

The Heating + Heating mode is typically used during cold seasons, such as winter. The Heating + Cooling mode is typically used during warm seasons, such as summer.

Heating + Heating mode

The controller acts as a heating controller and regulates based on the heating setpoint and the current room temperature.

The controller is always in heating mode and outputs two heating signals, Y1 and Y2, in sequence that are configured on the controller outputs by using the configuration values listed in table *Table 2-6*.

The Y1 output signal is associated with the 2-pipe fan coil and increases first to respond to the initial heating demand. The Y2 output signal is associated with the additional heating device and responds to any further heating demand that the 2-pipe fan coil cannot meet.

Maximum and minimum limits for the output signals can be set, see section 2.2.

Table 2-6 Controller output configuration values and controller output types.

Output signal	Controller output configuration value	Controller output type
Y1	Change-over valve	Analog
	Change-over valve, increase	Digital
	Change-over valve, decrease	Digital
	Change-over valve, thermal (PWM)	Digital
Y2	Heating	Analog
	Heating valve, increase	Digital
	Heating valve, decrease	Digital
	Heating valve, thermal (PWM)	Digital

Figure 2-8 illustrates the control behaviour for this mode when no maximum or minimum limits are set.

The heating demand increases as the room temperature falls. When the room temperature falls below the heating setpoint, Y1: Change-over (heating mode) signal increases to respond to the heating demand. At 49% heating demand, Y1: Change-over (heating mode) signal reaches its maximum. When the room temperature falls further and the heating demand exceeds 51%, Y2: Heating signal increases while Y1: Change-over (heating mode) signal stays at its maximum. At 100% heating demand, Y2: Heating signal reaches its maximum.

When the room temperature is higher than the heating setpoint and no heating demand exists, both Y1: Change-over (heating mode) signal and Y2: Heating signal are at their minimum.

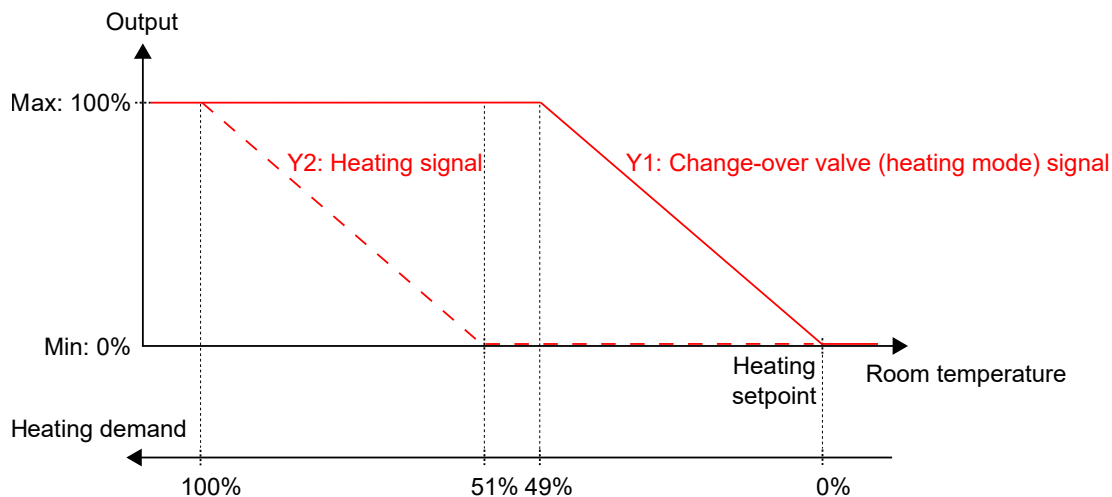

Figure 2-8 Control behaviour for the Heating + Heating/Cooling (change-over) controller mode when the controller is in Heating + Heating mode.

Heating + Cooling mode

The controller acts as a heating and cooling controller and regulates based on the heating setpoint, cooling setpoint, and the current room temperature.

The temperature range between the heating and cooling setpoints is defined as the deadband. The controller is in heating mode when the room temperature is lower than [heating setpoint plus half the deadband], and in cooling mode when the room temperature is higher than [cooling setpoint minus half the deadband].

When in cooling mode, the controller outputs a cooling signal, Y1, that is configured on the controller outputs by using the values listed in Table 2-3. The Y1 output signal is associated with the 2-pipe fan coil.

When in heating mode, the controller outputs a heating signal, Y2, that is configured on the controller outputs by using the values listed in Table 2-3. The Y2 output signal is associated with the additional heating device.

Maximum and minimum limits for the output signals can be set, see section 2.2.

Output signal	Controller output configuration value	Controller output type
Y1	Change-over valve	Analog
	Change-over valve, increase	Digital
	Change-over valve, decrease	Digital
Y2	Change-over valve, thermal (PWM)	Digital
	Heating	Analog
	Heating valve, increase	Digital
	Heating valve, decrease	Digital
	Heating valve, thermal (PWM)	Digital

Figure 2-9 illustrates the control behaviour for this mode when no maximum or minimum limits are set.

The heating demand increases as the room temperature falls. When the room temperature falls below the heating setpoint, Y2: Heating signal increases to respond to the heating demand. At 100% heating demand, Y2: Heating signal reaches its maximum. When the room temperature is in the range between the heating setpoint and the deadband centre, and no heating demand exists, Y2: Heating signal is at its minimum.

The cooling demand increases as the room temperature rises. When the room temperature rises above the cooling setpoint, Y1: Change-over (cooling mode) signal increases to respond to the cooling demand. At 100% cooling demand, Y1: Change-over (cooling mode) signal reaches its maximum. When the room temperature is in the range between the cooling setpoint and the deadband centre, and no cooling demand exists, Y1: Change-over (cooling mode) signal is at its minimum.

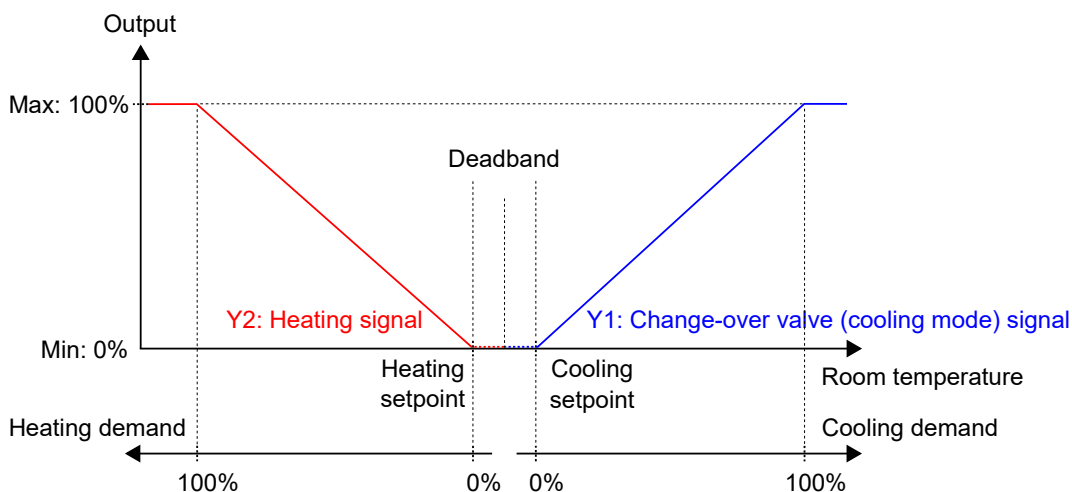

Figure 2-9 Control behaviour for the Heating + Heating/Cooling (change-over) controller mode when the controller is in Heating + Cooling mode.

2.1.7 Heating + VAV

This controller mode is suitable for room HVAC systems that use a radiator as heating device, and low supply air temperature that is distributed into the room via a diffuser damper to provide cooling and fresh air. The air must be pretreated and cooled, since the diffuser damper itself does not have any cooling capacity.

The controller acts as a heating and cooling controller and regulates based on the heating setpoint, cooling setpoint, and the current room temperature. In addition, the controller can be set to regulate based on fresh air demand instead of cooling demand, or based on cooling demand and fresh air demand simultaneously, see section 2.6. The controller regulates based on fresh air demand by using CO₂ control, see section 2.10.

The temperature range between the heating and cooling setpoints is defined as the deadband. The controller is in heating mode when the room temperature is lower than [heating setpoint plus half the deadband], and in cooling mode when the room temperature is higher than [cooling setpoint minus half the deadband].

When in heating mode, the controller outputs both a heating signal, Y1, and a VAV signal, Y2, that are configured on the controller outputs by using the values listed in *Table 2-3*.

When in cooling mode, the controller outputs a VAV signal, Y2, that is configured on the controller outputs by using the value listed in *Table 2-3*.

Maximum and minimum limits for the heating output signal can be set, see section 2.2. Maximum and minimum limits for the VAV output signal are set via the VAV control function, see section 2.6.

Table 2-7 Controller output configuration values and controller output types.

Output signal	Controller output configuration value	Controller output type
Y1	Heating	Analog
	Heating valve, increase	Digital
	Heating valve, decrease	Digital
	Heating valve, thermal (PWM)	Digital
Y2	VAV	Analog

Figure 2-10 illustrates the control behaviour when the controller regulates based on heating and cooling demand, when no maximum or minimum limits are set for the heating output signal, and when a minimum limit is set for the VAV output signal.

The heating demand increases as the room temperature falls. When the room temperature falls below the heating setpoint, Y1: *Heating signal* increases to respond to the heating demand. At 100% heating demand, Y1: *Heating signal* reaches its maximum. When the room temperature is in the range between the heating setpoint and the deadband centre, and no heating demand exists, Y1: *Heating signal* is at its minimum.

The cooling demand increases as the room temperature rises. When the room temperature rises above the cooling setpoint, Y2: *VAV signal* increases to respond to the cooling demand. At 100% cooling demand, Y2: *VAV signal* reaches its maximum. Y2: *VAV signal* never goes below its set minimum limit.

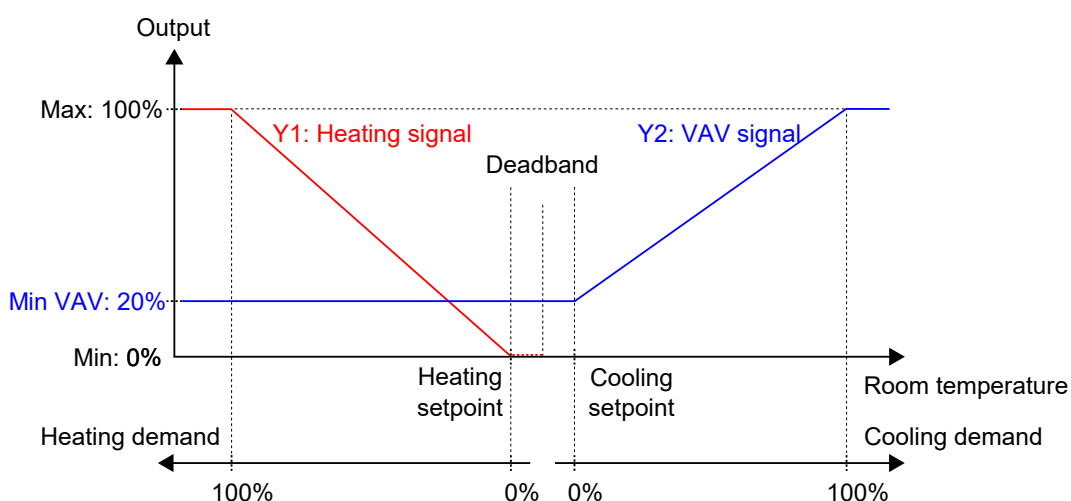

Figure 2-10 Control behaviour for the Heating + VAV controller mode when the controller regulates based on heating and cooling demand.

2.1.8 Cooling + VAV

This controller mode is suitable for room HVAC systems that use a chilled beam as cooling device, where the beam contains a cooling valve and a damper that regulates low supply air temperature that is distributed

into the room to provide cooling and fresh air. The air must be pretreated and cooled, since the damper itself does not have any cooling capacity.

The controller acts as a cooling controller and regulates based on the cooling setpoint and the current room temperature. In addition, the controller can be set to also regulate based on fresh air demand, or based on cooling demand and fresh air demand simultaneously, see section 2.6. The controller regulates based on fresh air demand by using CO₂ control, see section 2.10.

The controller is always in cooling mode and outputs a cooling signal, Y1, and a VAV signal, Y2, in sequence that are configured on the controller outputs by using the configuration values listed in table *Table 2-8*.

The Y1 and Y2 signal sequence order is configurable.

Maximum and minimum limits for the cooling output signal can be set, see section 2.2. Maximum and minimum limits for the VAV output signal are set via the VAV control function, see section 2.6.

Table 2-8 Controller output configuration values and controller output types.

Output signal	Controller output configuration value	Controller output type
Y1	Cooling	Analog
	Cooling valve, increase Cooling valve, decrease	Digital Digital
	Cooling valve, thermal (PWM)	Digital
Y2	VAV	Analog

Figure 2-11 illustrates the control behaviour when the controller regulates based on cooling demand, when no maximum or minimum limits are set for the cooling output signal, and when a minimum limit is set for the VAV output signal.

The cooling demand increases as the room temperature rises. When the room temperature rises above the cooling setpoint, Y1: Cooling signal increases to respond to the cooling demand. At 49% cooling demand, Y1: Cooling signal reaches its maximum. When the room temperature rises further and the cooling demand exceeds 51%, Y2: VAV signal increases while Y1: Cooling signal stays at its maximum. At 100% cooling demand, Y2: VAV signal reaches its maximum.

When the room temperature is lower than the cooling setpoint and no cooling demand exists, both Y1: Cooling signal and Y2: VAV signal are at their minimum.

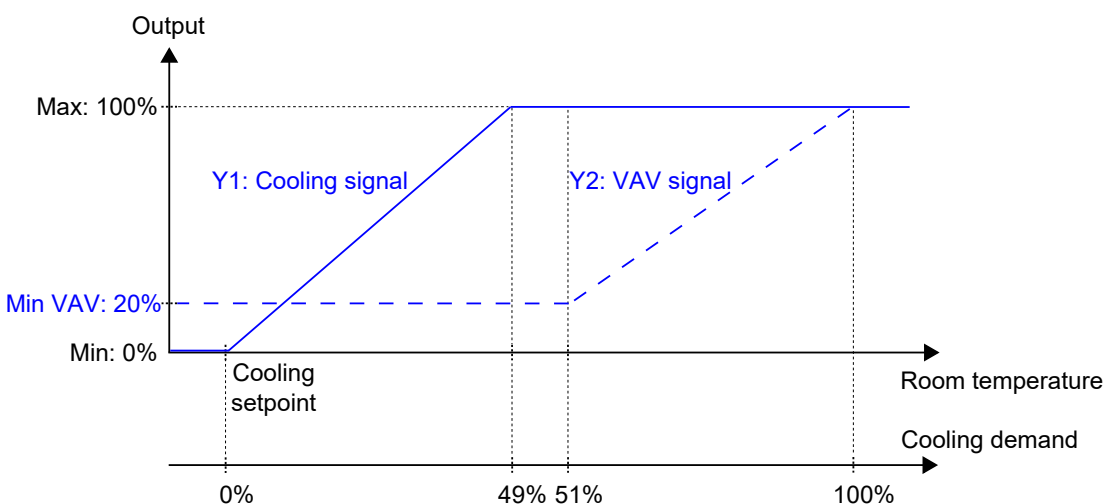

Figure 2-11 Control behaviour for the Cooling + VAV controller mode when the controller regulates based on cooling demand.

2.1.9 VAV

This controller mode is suitable for room HVAC systems that use low supply air temperature that is distributed into the room via a diffuser damper to provide cooling and fresh air. The air must be pretreated and cooled, since the diffuser damper itself does not have any cooling capacity.

The controller acts as a cooling controller and regulates based on the cooling setpoint and the current room temperature. In addition, the controller can be set to regulate based on fresh air demand instead of cooling demand, or based on cooling demand and fresh air demand simultaneously, see section 2.6. The controller regulates based on fresh air demand by using CO₂ control, see section 2.10.

The controller is always in cooling mode and outputs a VAV signal, Y1, that is configured on the controller outputs by using the configuration value listed in *Table 2-9*.

Maximum and minimum limits for the VAV output signal are set via the VAV control function, see section 2.6.

Table 2-9 Controller output configuration value and controller output type.

Output signal	Controller output configuration value	Controller output type
Y1	VAV	Analog

Figure 2-12 illustrates the control behaviour when the controller regulates based on cooling demand, and when a minimum limit is set for the VAV output signal.

The cooling demand increases as the room temperature rises. When the room temperature rises above the cooling setpoint, Y1: VAV signal increases to respond to the cooling demand. At 100% cooling demand, Y1: VAV signal reaches its maximum.

When the room temperature is lower than the cooling setpoint and no cooling demand exists, Y1: VAV signal is at its minimum.

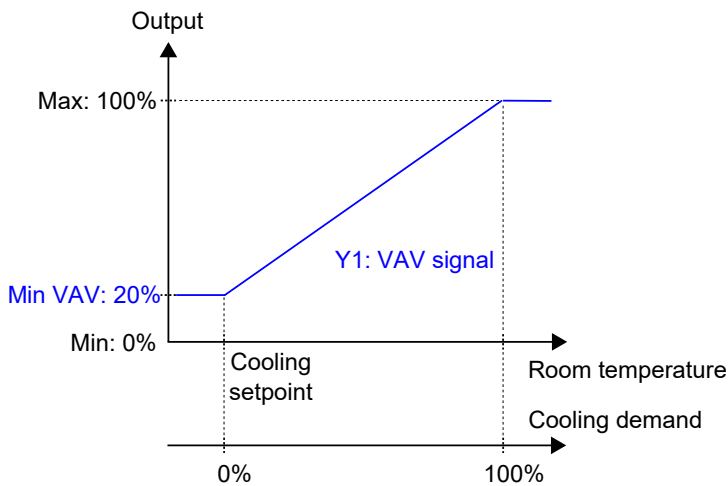

Figure 2-12 Control behaviour for the VAV controller mode when the controller regulates based on cooling demand.

2.1.10 Heating + Cooling + VAV

This controller mode is suitable for room HVAC systems that use a radiator as heating device and a chilled beam as cooling device, where the beam contains a cooling valve and a damper that regulates low supply air temperature that is distributed into the room to provide cooling and fresh air. The air must be pretreated and cooled, since the damper itself does not have any cooling capacity.

The controller acts as a heating and cooling controller and regulates based on the heating setpoint, cooling setpoint, and the current room temperature. In addition, the controller can be set to also regulate based on

fresh air demand, or based on cooling demand and fresh air demand simultaneously, see section 2.6. The controller regulates based on fresh air demand by using CO₂ control, see section 2.10.

The temperature range between the heating and cooling setpoints is defined as the deadband. The controller is in heating mode when the room temperature is lower than [heating setpoint plus half the deadband], and in cooling mode when the room temperature is higher than [cooling setpoint minus half the deadband].

When in heating mode, the controller outputs both a heating signal, Y1, and a VAV signal, Y3, that are configured on the controller outputs by using the values listed in *Table 2-10*.

When in cooling mode, the controller outputs a cooling signal, Y2, and a VAV signal, Y3, in sequence that are configured on the controller outputs by using the configuration values listed in *Table 2-10*.

The Y2 and Y3 signal sequence order is configurable.

Maximum and minimum limits for the heating and cooling output signals can be set, see section 2.2.

Maximum and minimum limits for the VAV output signal are set via the VAV control function, see section 2.6.

Table 2-10 Controller output configuration values and controller output types.

Output signal	Controller output configuration value	Controller output type
Y1	Heating	Analog
	Heating valve, increase	Digital
	Heating valve, decrease	Digital
	Heating valve, thermal (PWM)	Digital
Y2	Cooling	Analog
	Cooling valve, increase	Digital
	Cooling valve, decrease	Digital
	Cooling valve, thermal (PWM)	Digital
Y1 + Y2	6-way valve	Analog
	6-way valve, increase	Digital
	6-way valve, decrease	Digital
Y3	VAV	Analog

Figure 2-13 illustrates the control behaviour when the controller regulates based on heating and cooling demand, when no maximum or minimum limits are set for the heating or cooling output signals, and when a minimum limit is set for the VAV output signal.

The heating demand increases as the room temperature falls. When the room temperature falls below the heating setpoint, Y1: *Heating signal* increases to respond to the heating demand. At 100% heating demand, Y1: *Heating signal* reaches its maximum. When the room temperature is in the range between the heating setpoint and the deadband centre, and no heating demand exists, Y1: *Heating signal* is at its minimum.

The cooling demand increases as the room temperature rises. When the room temperature rises above the cooling setpoint, Y2: *Cooling signal* increases to respond to the cooling demand. At 49% cooling demand, Y2: *Cooling signal* reaches its maximum. When the room temperature rises further and the cooling demand exceeds 51%, Y3: *VAV signal* increases while Y2: *Cooling signal* stays at its maximum. At 100% cooling demand, Y3: *VAV signal* reaches its maximum. When the room temperature is in the range between the cooling setpoint and the deadband centre, and no cooling demand exists, both Y2: *Cooling signal* and Y3: *VAV signal* are at their minimum.

Y3: *VAV signal* never goes below its set minimum limit.

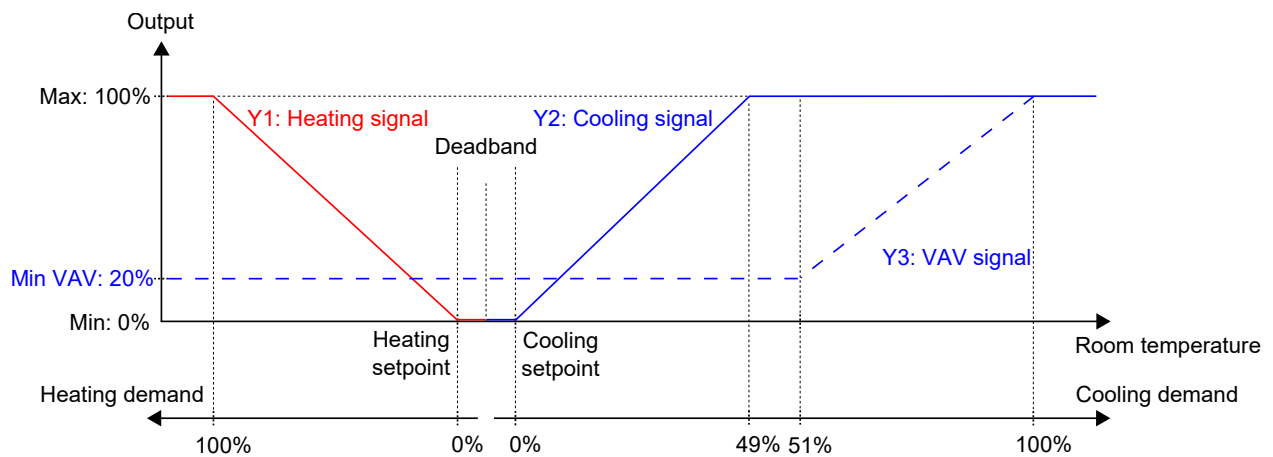

Figure 2-13 Control behaviour for the Heating + Cooling + VAV controller mode when the controller regulates based on heating and cooling demand.

2.2 Maximum and minimum limits for heating and cooling output

Maximum and minimum limits for the heating and cooling output signals can be set. Figure 2-14 shows the configuration settings in Application tool.

Maximum and minimum limits for the VAV output signal are set via the VAV control function, see section 2.6.

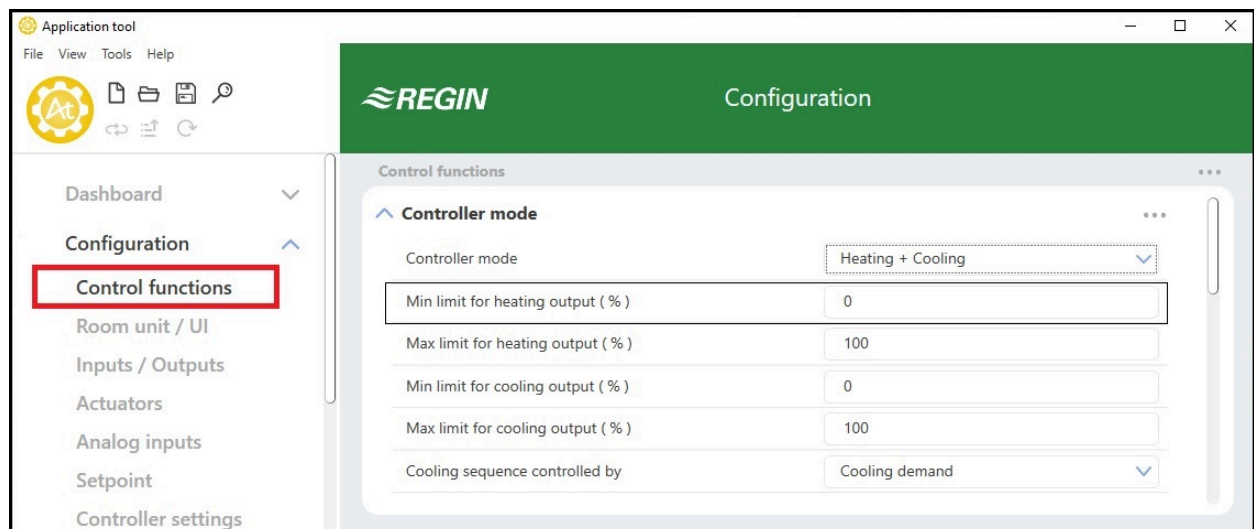

Figure 2-14 Configuration settings for maximum and minimum heating and cooling output limits in Application tool.

The heating output limits are active when the controller is in heating mode, and inactive when the controller is not in heating mode. When the controller is in heating mode or not is defined by the used controller mode, see section 2.1.

Figure 2-15 illustrates how the control behaviour is affected when limits are set for the heating output. For example, when a 85% maximum limit is set, Heating signal never exceeds 85% of its practical maximum (100%). When a 20% minimum limit is set, Heating signal is always at least 20%, as long as the controller is in heating mode.

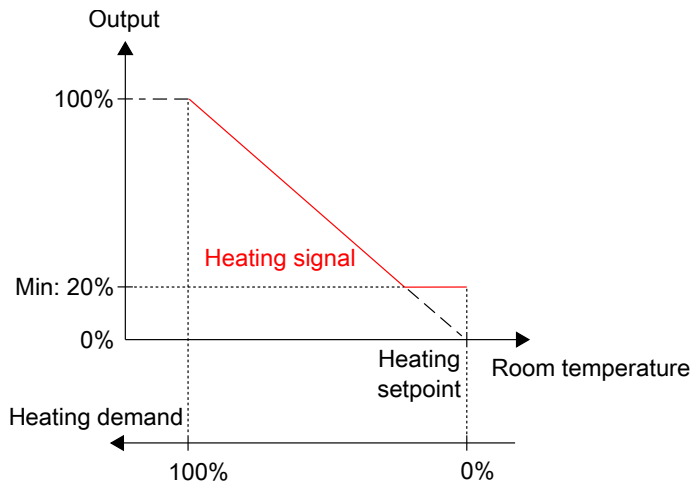

Figure 2-15 Control behaviour when maximum and minimum limits are set for the heating output.

The cooling output limits are active when the controller is in cooling mode, and inactive when the controller is not in cooling mode. When the controller is in cooling mode or not is defined by the used controller mode, see section 2.1.

Figure 2-16 illustrates how the control behaviour is affected when limits are set for the cooling output. For example, if a 85% maximum limit is set, *Cooling signal* never exceeds 85% of its practical maximum (100%). When a 20% minimum limit is set, *Cooling signal* is always at least 20%, as long as the controller is in cooling mode.

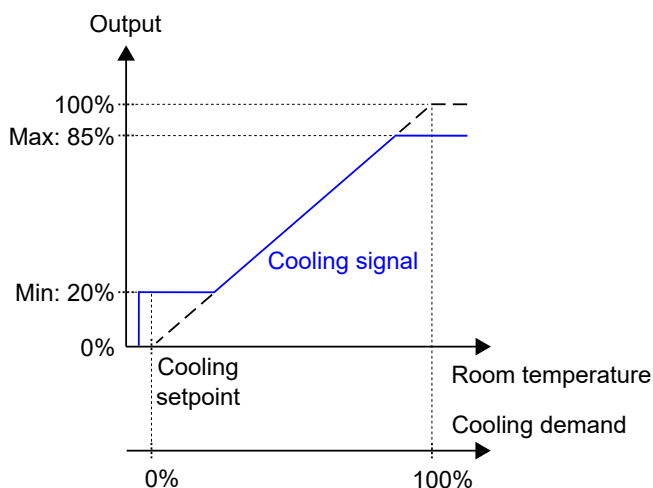

Figure 2-16 Control behaviour when maximum and minimum limits are set for the cooling output.

2.3 Change-over

Change-over is a control function that enables the controller to provide both a heating or a cooling signal on the same controller output. This is achieved by shifting the controller change-over state from *heating* to *cooling*, and vice versa. The change-over function makes it possible to use the controller in a 2-pipe change-over HVAC system, where warm or cold media flow in the same pipes and one valve is used to regulate both heating and cooling distribution.

The controller change-over state is either *heating* or *cooling*, and is managed automatically via change-over detection, see section 2.3.1. The controller change-over state can also be set manually via the Manual / Auto settings, or via communication.

The change-over function is enabled and the configuration settings for change-over detection are shown in Application tool when one of the following controller modes is selected:

- ✓ Heating/Cooling (change-over)
- ✓ Heating + Heating/Cooling (change-over)

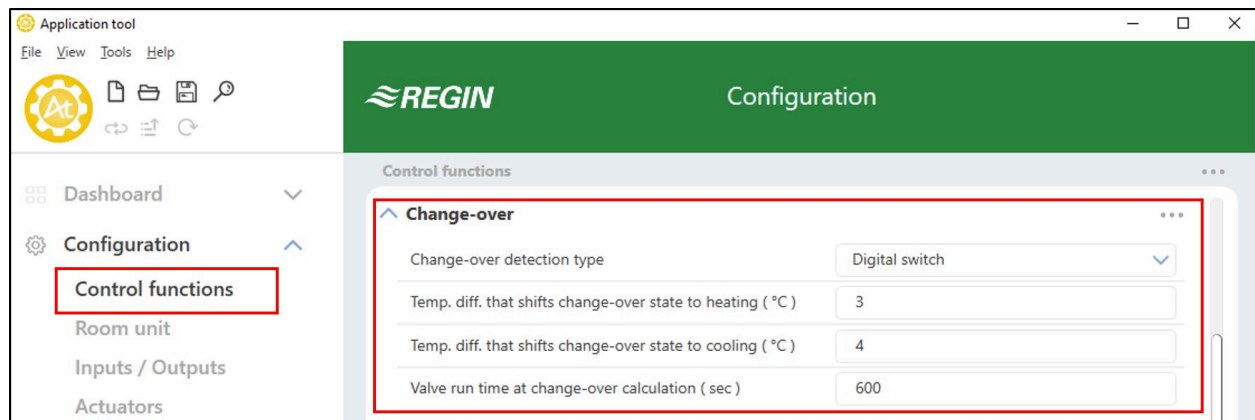

Figure 2-17 Change-over detection configuration settings in Application tool.

2.3.1 Change-over detection

Change-over detection is performed either by using a PT1000 sensor that is connected to an analog input, or by using a potential-free contact that is connected to a digital input. The PT1000 sensor is mounted so that it senses the pipe medium temperature.

When using a PT1000 sensor for change-over detection, the shift in controller change-over state is triggered based on the difference between the pipe medium temperature and the room temperature. The controller shifts the change-over state to *heating* when the pipe medium temperature is 3°C (default setting) higher than the room temperature. The controller shifts the change-over state to *cooling* when the pipe medium temperature is 4°C (default setting) lower than the room temperature.

When using a potential-free contact for change-over detection, the controller shifts the controller change-over state to *cooling* when the contact is closed. The controller shifts the controller change-over state to *heating* when the contact is open. This assumes that the digital input is set to **Normally opened**, see the *Configuration -> Inputs / Outputs* pane in Application tool.

Change-over detection is configured on the controller inputs by using the values listed in *Table 2-11*.

Table 2-11 Change-over detection configuration values and controller input types.

Controller input configuration value	Controller input type
Change-over temperature	Analog
Change-over	Digital

The configuration settings for change-over detection are described in *Table 2-12*.

Table 2-12 Change-over detection configuration settings.

Configuration setting	Description
Change-over detection type	Digital switch: Must be selected if a digital input is used for change-over detection (default setting). Analog temperature in incoming pipe: Must be selected if an analog input is used for change-over detection.
Temp. diff. that shifts change-over state to heating (°C)	The controller shifts the change-over state to <i>heating</i> when the pipe medium temperature is this amount of degrees higher than the room temperature.

Table 2-12 Change-over detection configuration settings. (continued)

Configuration setting	Description
Temp. diff. that shifts change-over state to cooling (°C)	The controller shifts the change-over state to <i>cooling</i> when the pipe medium temperature is this amount of degrees lower than the room temperature.
Valve run time at change-over calculation (sec)	The period of time (in seconds) that the valve is open before the pipe medium temperature is measured and compared to the room temperature.

2.4 Controller state

Controller state is a control function that makes it possible for the room HVAC system to operate with priority on comfort or energy saving.

The following controller states are available for use and the controller always operates in one of them:

- ✓ Off
- ✓ Unoccupied
- ✓ Standby
- ✓ Occupied
- ✓ Bypass

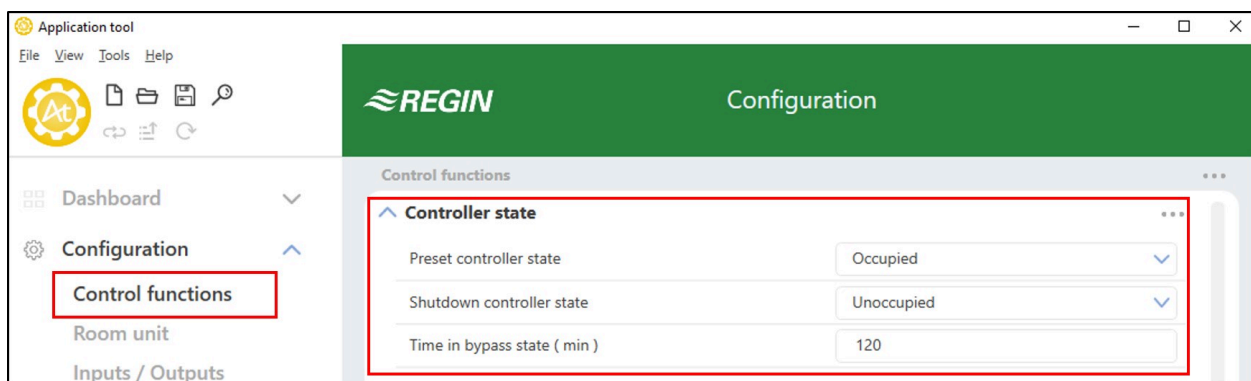

Figure 2-18 Controller state configuration settings in Application tool.

The different controller states make use of various setpoint and deadband settings to regulate the heating and cooling distribution, as described in section 2.4.1. See section 5 for information about setpoint and deadband settings, and setpoint adjustment.

Controller state configuration settings are described in section 2.4.2, and controller state changes are described in section 2.4.3.

An overview of the controller states is provided in Table 2-13.

Table 2-13 Controller state overview.

Controller state	Description	Priority	Indications in room units with display	LED indication in room units without display
Off	This state is typically used for when the room is not in use for an extended period of time, for example, during holidays or long weekends. In this state, the controller only provides heating control for frost protection, which keeps the room temperature above 8 °C.	Energy saving and frost protection	<ul style="list-style-type: none"> ✓ OFF indication is shown. ✓ HEAT indication is shown when the demand is greater than zero. 	✓ Off
Unoccupied	This state is typically used for when the room is not in use for an extended period of time, for example, during holidays or long weekends.	Energy saving	<ul style="list-style-type: none"> ✓ OFF indication is shown. ✓ HEAT or COOL indication is shown when the demand is greater than zero. ✓ The room temperature, setpoint, setpoint adjustment, or CO₂ level is shown (according to the current room unit configuration, see section 3.7.3). 	✓ Off
Standby	This state is typically used for when the room is not in use, temporarily or for shorter periods of time, such as during evenings, nights, or weekends.	Energy saving	<ul style="list-style-type: none"> ✓ STANDBY indication is shown. ✓ HEAT or COOL indication is shown when the demand is greater than zero. ✓ The room temperature, setpoint, setpoint adjustment, or CO₂ level is shown (according to the current room unit configuration, see section 3.7.3). 	✓ Blinking
Occupied	This state is typically used for when the room is in use.	Comfort	<ul style="list-style-type: none"> ✓ Occupancy indication is shown. ✓ HEAT or COOL indication is shown when the demand is greater than zero. ✓ The room temperature, setpoint, setpoint adjustment, or CO₂ level is shown (according to the current room unit configuration, see section 3.7.3). 	✓ Solid
Bypass	This state is typically used for when the room is in use, and when a temporary maximum flow of fresh air is needed. For example, when the room needs an extra boost of fresh air prior to a scheduled meeting that is going to fill up the room with a large amount of people, or due to high a CO ₂ level. The increase in airflow is achieved by using the forced ventilation function, see section 2.7.	Comfort and improved air quality	<ul style="list-style-type: none"> ✓ Occupancy indication is shown. ✓ HEAT or COOL indication is shown when the demand is greater than zero. ✓ Forced ventilation indication is shown when forced ventilation is active. ✓ The room temperature, setpoint, setpoint adjustment, or CO₂ level is shown (according to the current room unit configuration, see section 3.7.3). 	✓ Blinking slowly

2.4.1 Control behaviour

This section describes the control behaviour for the different controller states when the controller regulates based on heating and cooling demand.

Off

In this state, the controller does not regulate based on the configured occupied heating and cooling setpoints. Instead, the controller only provides heating control based on the configured frost protection setpoint. Setpoint adjustment is not active in this controller state.

Active setpoint: The configured frost protection setpoint.

Figure 2-19 illustrates the control behaviour when no maximum or minimum limits are set for the output signal.

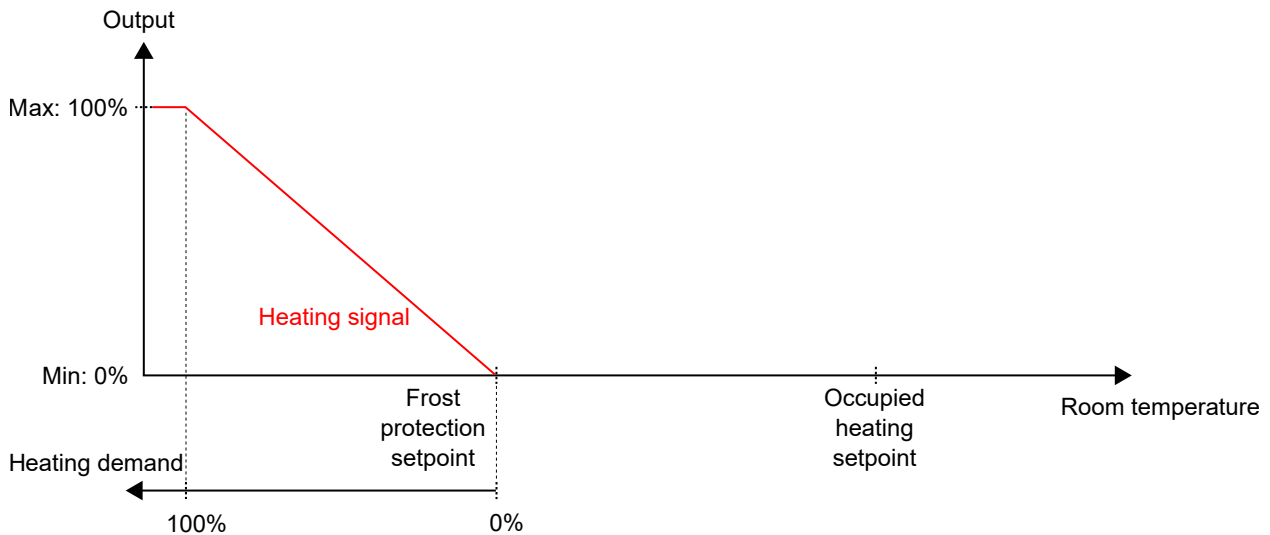

Figure 2-19 Control behaviour for the off controller state.

Unoccupied

In this state, the controller does not regulate based on the configured occupied heating and cooling setpoints. Instead, the controller provides heating and cooling control based on the configured unoccupied heating and cooling setpoints. Setpoint adjustment is not active in this controller state.

Active setpoints: The configured unoccupied heating and cooling setpoints.

Figure 2-20 illustrates the control behaviour when no maximum or minimum limits are set for the output signals.

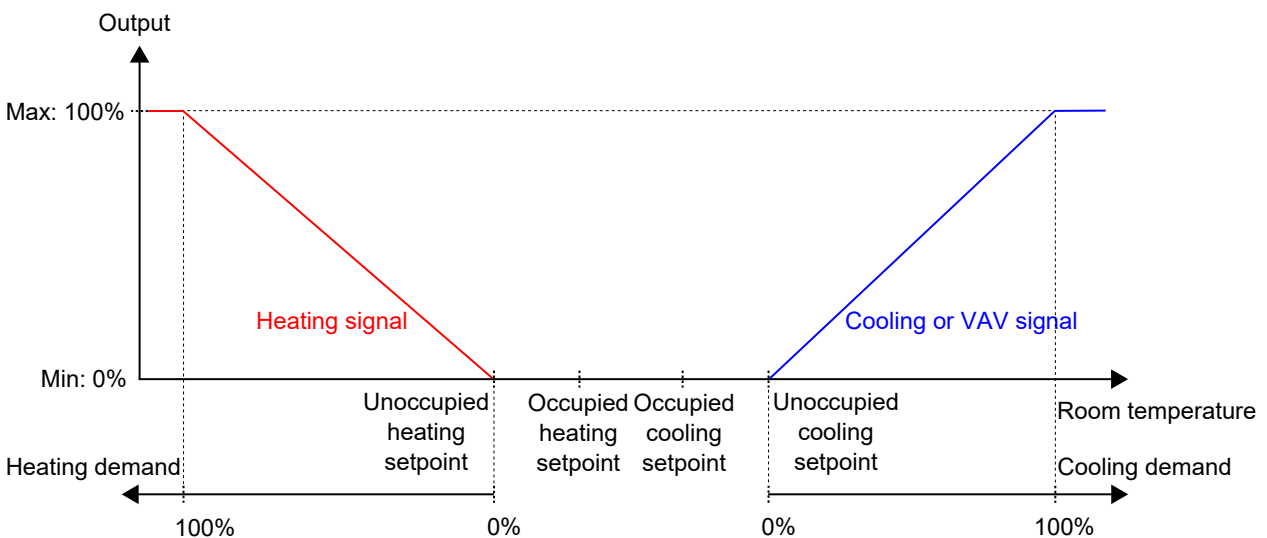

Figure 2-20 Control behaviour for the unoccupied controller state.

Standby

In this state, the controller regulates based on the configured occupied heating and cooling setpoints, in combination with the configured *standby deadband* setting. Setpoint adjustment is active in this controller state.

Active setpoints: The configured occupied heating and cooling setpoints, combined with the configured *standby deadband* setting and any applied setpoint adjustment.

Figure 2-21 illustrates the control behaviour when no maximum or minimum limits are set for the output signals.

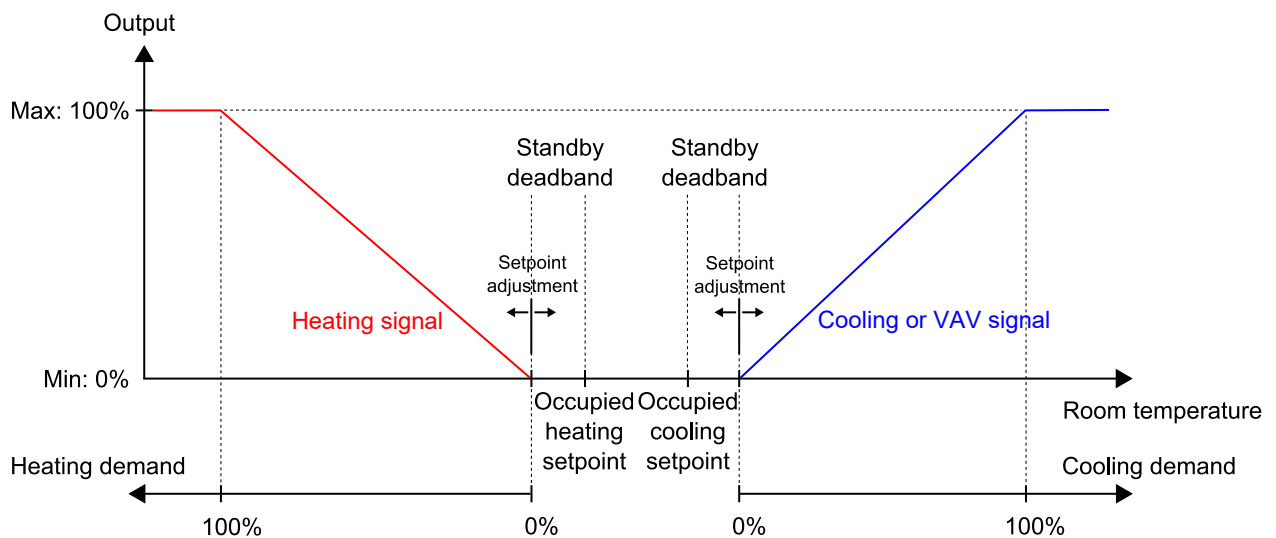

Figure 2-21 Control behaviour for the standby controller state.

Occupied and Bypass

In these states, the controller regulates based on the configured occupied heating and cooling setpoints. Setpoint adjustment is active in these controller states.

The forced ventilation function can be used when the controller changes to bypass state. See section 2.7 for information about the forced ventilation function.

Active setpoints: The configured occupied heating and cooling setpoints, combined with any applied setpoint adjustment.

Figure 2-22 illustrates the control behaviour when no maximum or minimum limits are set for the output signals.

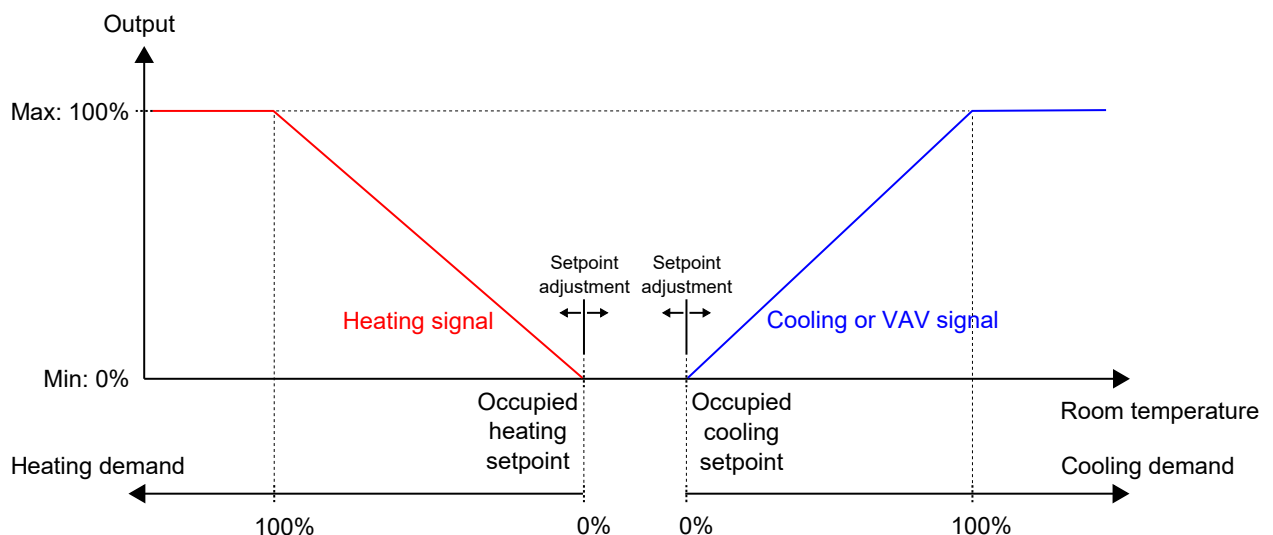

Figure 2-22 Control behaviour for the occupied and bypass controller state.

2.4.2 Configuration settings

The controller state configuration settings are described in Table 2-14.

Table 2-14 Controller state configuration settings.

Configuration setting	Description
Preset controller state	One of the following controller states is configured as the preset controller state: <ul style="list-style-type: none"> ✓ Off ✓ Unoccupied ✓ Standby ✓ Occupied (default setting)
Shutdown controller state	One of the following controller states is configured as the shutdown controller state: <ul style="list-style-type: none"> ✓ Off ✓ Unoccupied (default setting) ✓ Standby ✓ Occupied
Time in bypass state (min)	The period of time (in minutes) that the controller is in bypass state before the controller changes state to the configured preset controller state.

2.4.3 State changes

The controller changes state when one of the following events occur:

- ✓ The occupancy (on/off) button on the room unit is pressed shorter than 5 seconds (short press).
- ✓ The occupancy (on/off) button on the room unit is pressed for more than 5 seconds (long press).
- ✓ Presence is detected:
 - ✓ Via a presence detector, for example, a motion detector, which is connected to the controller.
 - ✓ Due to a high CO₂ level that is detected via a CO₂ sensor, which is connected to the controller.

See section 2.8 for information about the presence detection function and presence detection configuration settings.

- ✓ The bypass state timeout expires.
- ✓ Presence is not detected anymore.
- ✓ A schedule (occupied or unoccupied) is activated or deactivated.
- ✓ A central command is issued via communication, for example, from a SCADA system.

The following sections provide flow charts that describe how the different events trigger controller state changes.

Occupancy (on/off) button on room unit

Figure 2-23 describes controller state changes for when the occupancy (on/off) button on the room unit is used.

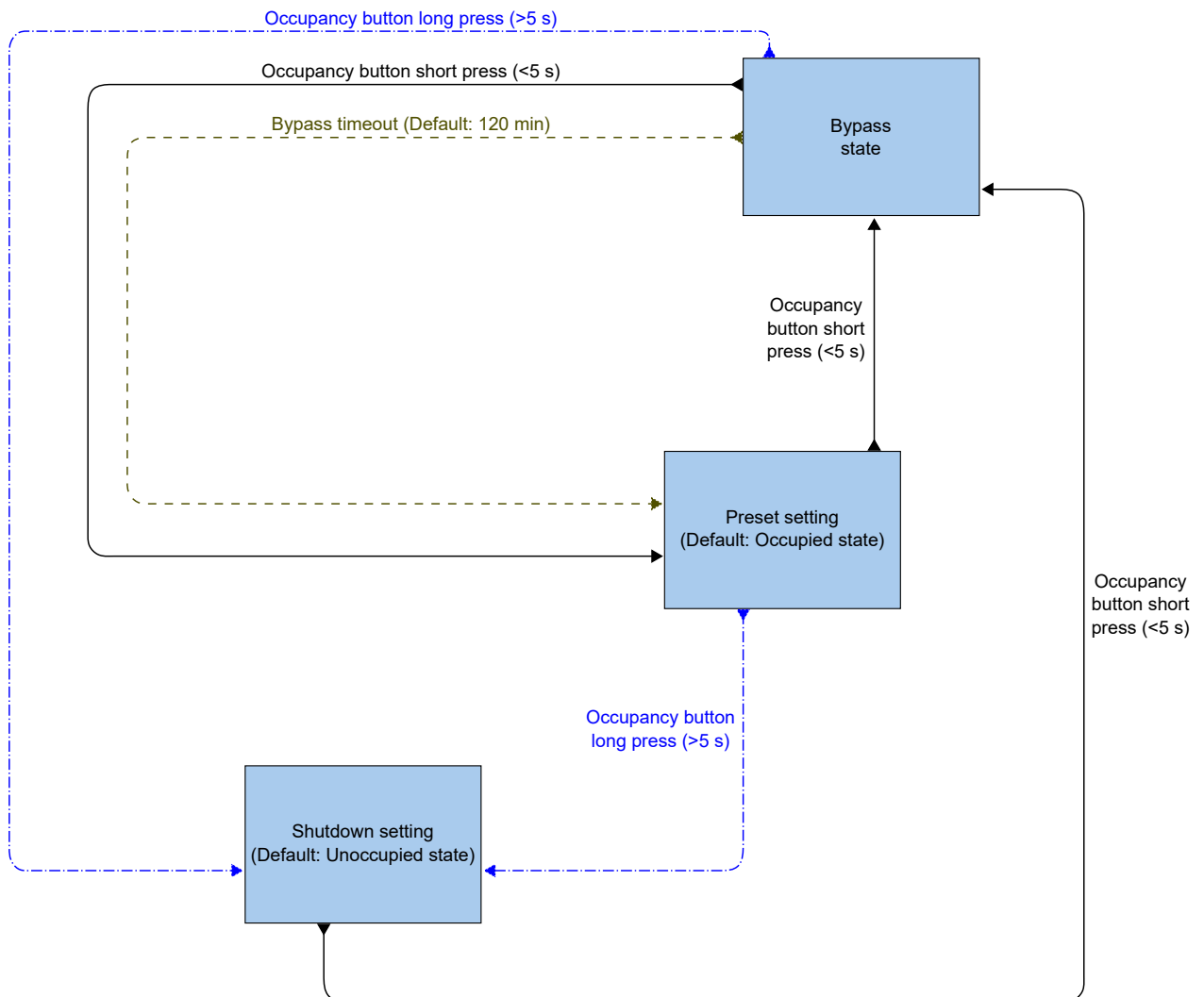

Figure 2-23 Flow chart describing controller state changes for when the occupancy (on/off) button on the room unit is used.

Presence detection and occupancy (on/off) button on room unit

Figure 2-24 describes controller state changes for when presence detection and the occupancy (on/off) button on the room unit are used.

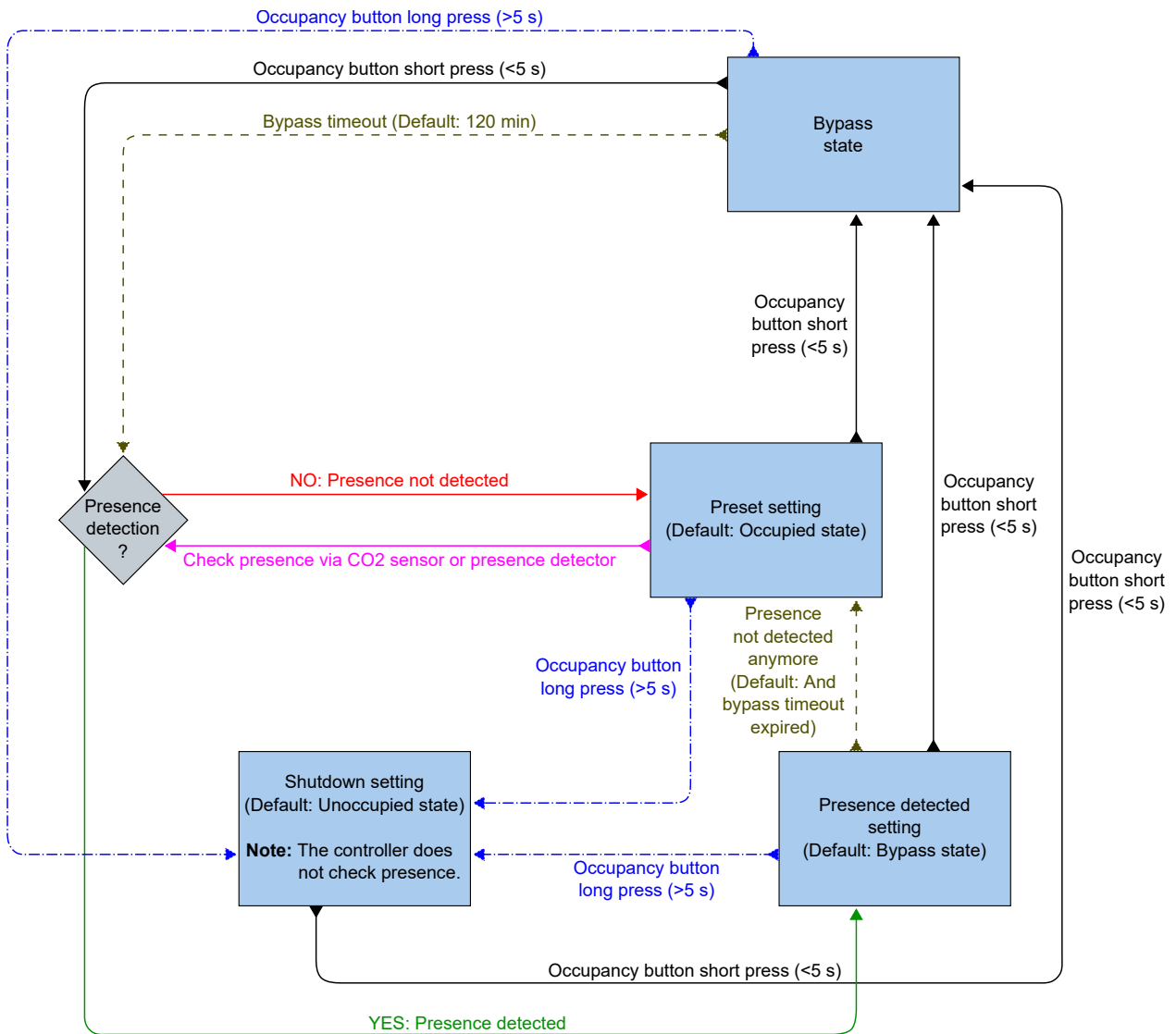

Figure 2-24 Flow chart describing controller state changes for when presence detection and the occupancy (on/off) button on the room unit are used.

Schedules and occupancy (on/off) button on room unit

Figure 2-25 describes controller state changes for when schedules and the occupancy (on/off) button on the room unit are used.

The occupied schedule has precedence. That is, if the occupied and unoccupied schedules are configured as active during the same period of time, the occupied schedule is active.

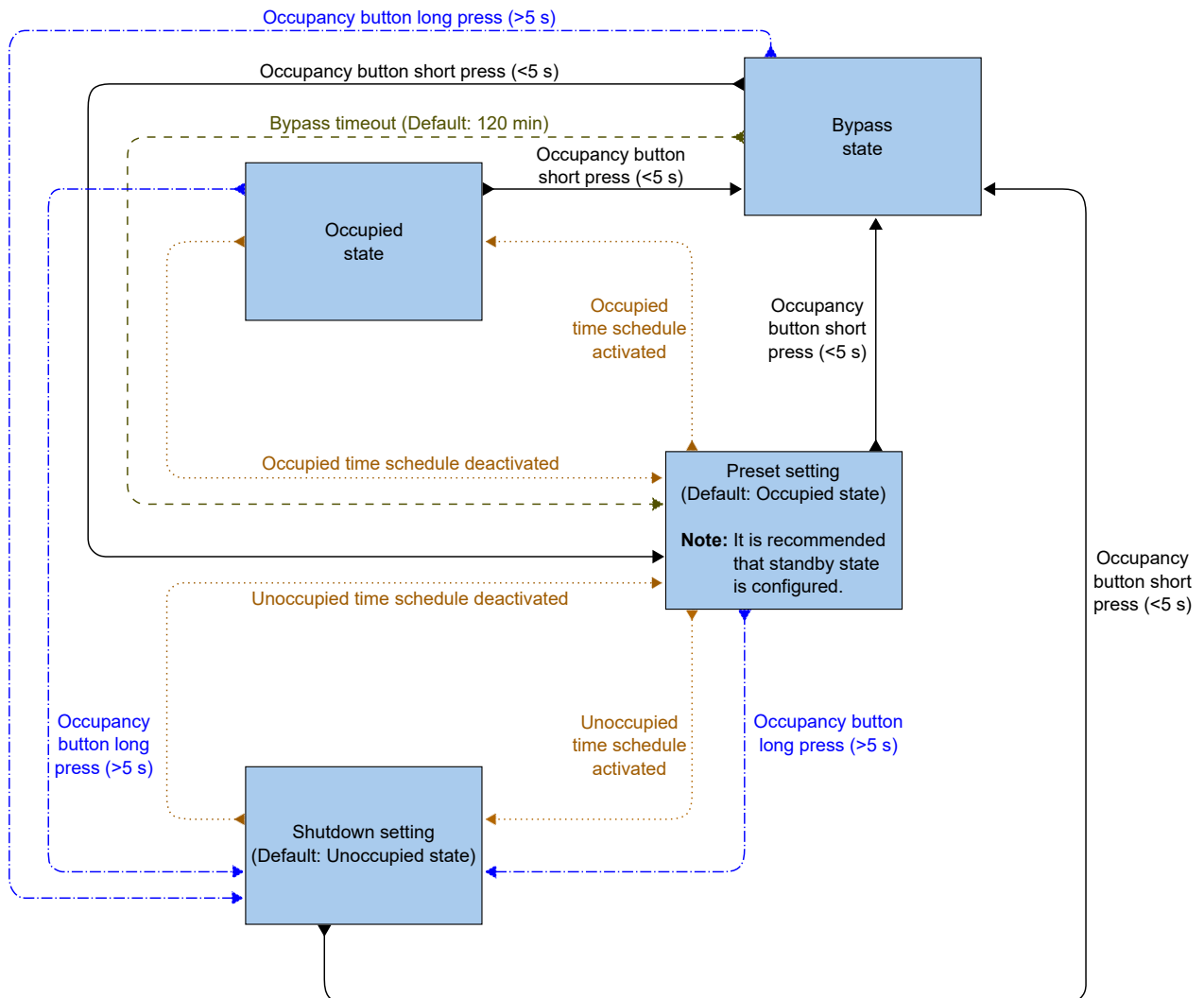

Figure 2-25 Flow chart describing controller state changes for when schedules and the occupancy (on/off) button on the room unit are used.

2.5 Fan control

The fan control function enables the controller to regulate the fan speed for EC fans or 3-speed fans.

A fan is controlled in auto or manual mode. In auto mode, the fan speed is determined by the current heating or cooling demand. In manual mode, one of the following speeds is used:

- ✓ Off
- ✓ Low speed: Fan speed 1
- ✓ Medium speed: Fan speed 2
- ✓ High speed: Fan speed 3

The operative fan mode that is currently in use, that is, auto or manual (off, low speed, medium speed, or high speed), is selected by the end user via the room unit, or set via communication. When the controller is in the state specified by the *Shutdown controller state* setting, see section 2.4.2, the operative fan mode is always auto.

In addition, fan control provides the following optional functions:

- ✓ Fan boost, see section 2.5.3.
- ✓ Fan kick-start see section 2.5.4.
- ✓ Fan afterblow see section 2.5.5.

2.5.1 EC fan control

The EC fan control function is enabled and the EC fan control configuration settings are shown in Application tool when the configuration value listed in *Table 2-15* is configured on a controller output.

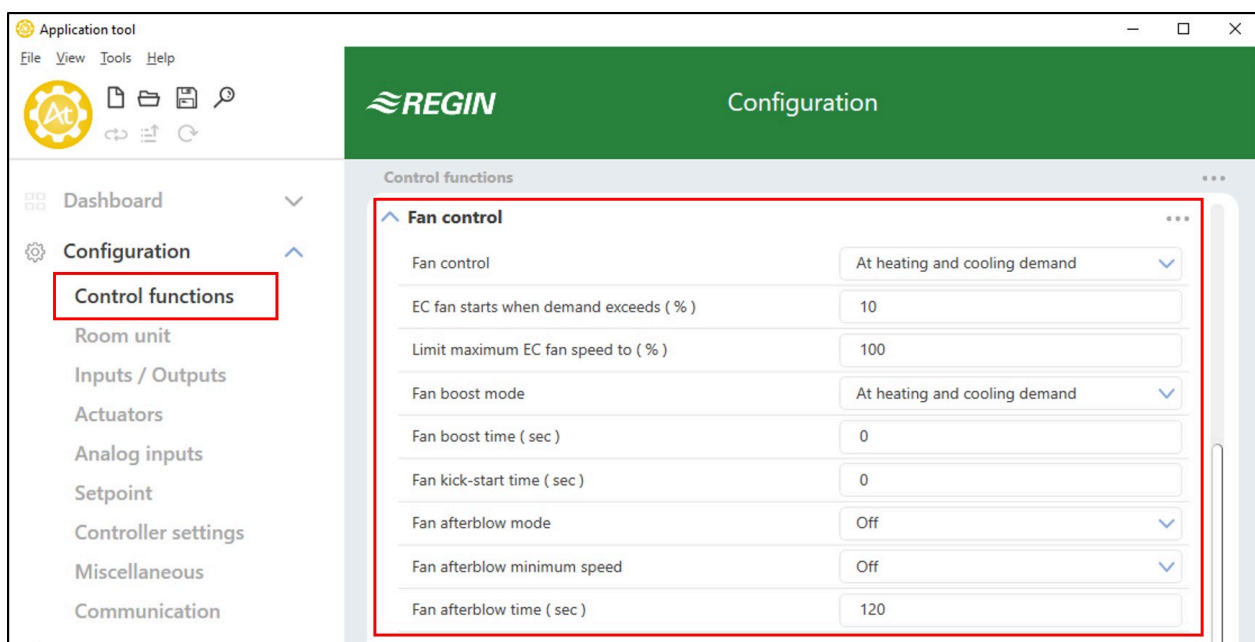

Figure 2-26 EC fan control configuration settings in Application tool.

The controller outputs a fan speed signal, Y1, that is configured on a controller output by using the value in *Table 2-15*.

In auto mode, the Y1 signal corresponds to the current heating or cooling demand, as illustrated in *Figure 2-27*.

In manual mode, the Y1 signal is independent of the current heating or cooling demand. Instead, the fan speed 1, 2, and 3 signals are defined by a number of equal thirds relative to the *Limit maximum EC fan speed to (%)* configuration setting, as illustrated in *Figure 2-28*. For example, the fan speed 1 signal is equal to 0.33 times the set maximum fan speed value, and the fan speed 2 signal is equal to 0.67 times the set maximum fan speed value.

Table 2-15 EC fan control configuration value and controller input type.

Output signal	Controller output configuration value	Controller output type
Y1	EC fan	Analog

The EC fan control configuration settings are described in *Table 2-16*.

Table 2-16 EC fan control configuration settings.

Configuration setting	Fan mode applicability	Description
Fan control	Auto	Disabled: Fan control in auto mode is disabled (default setting). At cooling demand: Fan control in auto mode is active at cooling demand. At heating demand: Fan control in auto mode is active at heating demand. At heating and cooling demand: Fan control in auto mode is active both at heating and cooling demand.
Fan speed at no demand	Auto	Fan behaviour when there is no demand Stop: The fan will be stopped (default setting). Fan speed 1 / EC fan start speed: 3-speed fans will run at <i>Fan speed 1</i> . EC-fan will run at the set speed of <i>EC fan start speed (%)</i>
EC fan start speed (%) ¹	Auto and manual	The fan starts at this speed.
EC fan starts when demand exceeds (%)	Auto	The fan starts when this heating or cooling demand is exceeded.
Limit maximum EC fan speed to (%)	Auto and manual	In auto mode, the maximum fan speed is set by this value. In manual mode, the maximum fan speed is set by this value, and each fan speed is defined as: ✓ Fan speed 1 = 0.33 * this value ✓ Fan speed 2 = 0.67 * this value ✓ Fan speed 3 = 1 * this value
EC fan speed at forced ventilation (%) ¹	Auto and manual	The speed at which the fan will run when the forced ventilation is activated.

1. Only available in Regio Eedo version 2.0-1-04 or later

Figure 2-27 illustrates the EC fan control behaviour in auto mode when a 90% maximum limit is set for the fan speed output signal, and a 10% heating and cooling demand threshold value for when the fan should start is set.

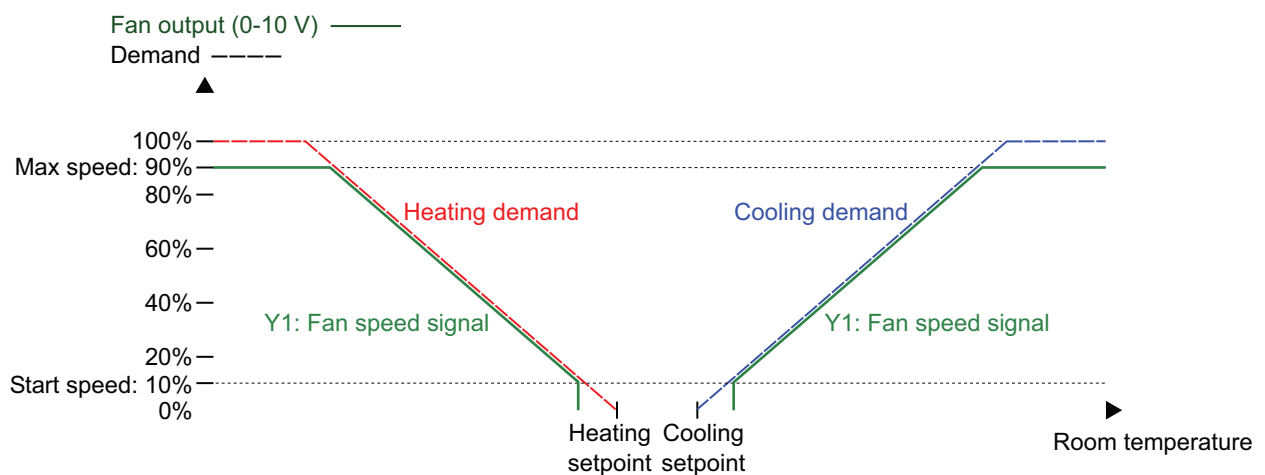

Figure 2-27 EC fan control behaviour in auto mode.

Figure 2-28 illustrates the EC fan control behaviour in manual mode when a 90% maximum limit is set for the fan speed output signal.

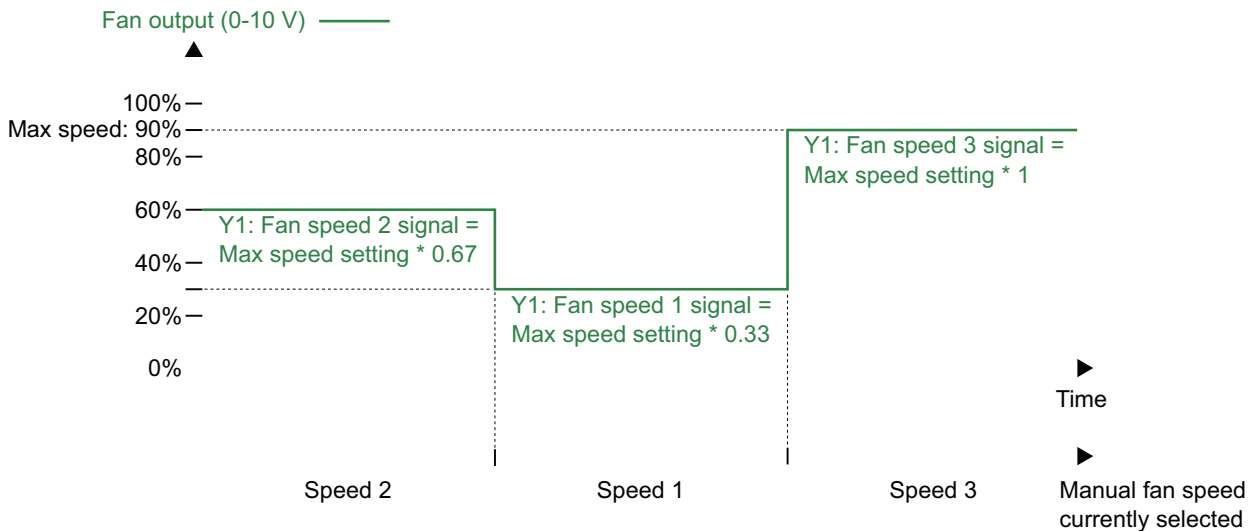

Figure 2-28 EC fan control behaviour in manual mode (fan speed 1, 2 or 3)

2.5.2 3-speed fan control

The 3-speed fan control function is enabled and the 3-speed fan control configuration settings are shown in Application tool when any of the configuration values listed in *Table 2-17* are configured on a controller output.

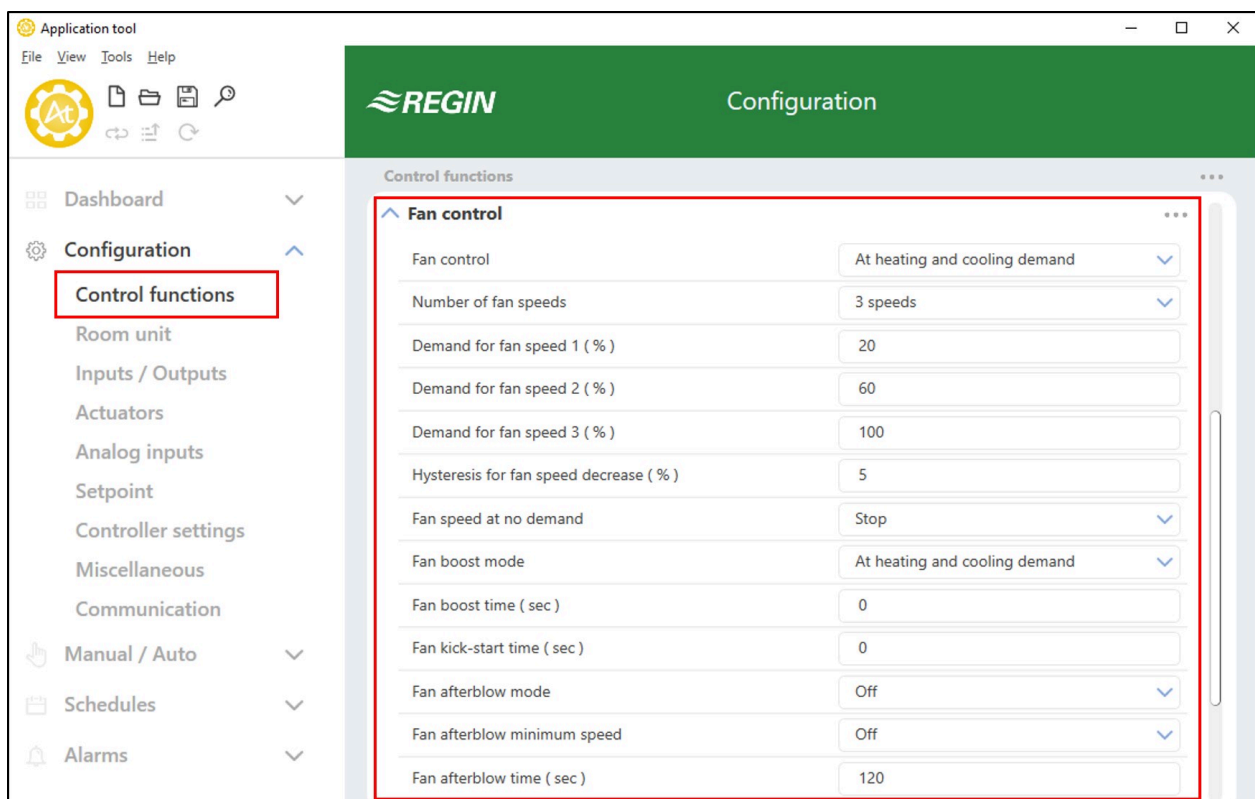

Figure 2-29 3-speed fan control configuration settings in Application tool.

The controller outputs 3 fan speed signals, Y1, Y2, and Y3, that are configured on the controller outputs by using the values listed in *Table 2-17*.

In auto mode, the Y1, Y2, or Y3 signal is active when the current heating or cooling demand is higher than the corresponding *Demand for fan speed [nr] (%)* configuration setting, as illustrated in *Figure 2-30*.

In manual mode, the Y1, Y2, and Y3 signals are independent of the current heating or cooling demand. Instead, each fan speed signal is active when the corresponding fan speed is selected in the room unit or set via communication, as illustrated in *Figure 2-31*.

Table 2-17 3-speed fan control configuration values and controller output types.

Output signal	Controller output configuration value	Controller output type
Y1	Fan speed 1	Digital
Y2	Fan speed 2	Digital
Y3	Fan speed 3	Digital

Table 2-18 3-speed fan control configuration settings.

Configuration setting	Fan mode applicability	Description
Fan control	Auto	<p>Disabled: Fan control in auto mode is disabled (default setting).</p> <p>At cooling demand: Fan control in auto mode is active at cooling demand.</p> <p>At heating demand: Fan control in auto mode is active at heating demand.</p> <p>At heating and cooling demand: Fan control in auto mode is active at both heating and cooling demand.</p>
Number of fan speeds	Auto and manual	<p>None: Fan control in auto and manual mode is disabled.</p> <p>1 speed: Only the fan speed 1 signal is used. In auto mode, this means that the controller outputs the fan speed 1 signal instead of the fan speed 2 and 3 signals.</p> <p>2 speeds: Only the fan speed 1 and 2 signals are used. In auto mode, this means that the controller outputs the fan speed 2 signal instead of the fan speed 3 signal.</p> <p>3 speeds: All 3 fan speed signals are used (default setting).</p>
Demand for fan speed 1 (%)	Auto	The fan speed 1 signal is active when the current heating or cooling demand is higher than this value and lower than the value set by the <i>Demand for fan speed 2 (%)</i> setting.
Demand for fan speed 2 (%)	Auto	The fan speed 2 signal is active when the current heating or cooling demand is higher than this value and lower than the value set by the <i>Demand for fan speed 3 (%)</i> setting.
Demand for fan speed 3 (%)	Auto	The fan speed 3 signal is active when the current heating or cooling demand is higher than this value.
Hysteresis for fan speed decrease (%)	Auto	Specifies the hysteresis for when a decrease in fan speed occurs. For example, if the <i>Demand for fan speed 2 (%)</i> setting is 60% and this setting is 5%, the fan speed 2 signal is deactivated when the heating or cooling demand decrease below $60 - 5 = 55\%$. At the same time, the fan speed 1 signal is activated.
Fan speed at no demand	Auto	<p>Fan behaviour when there is no demand</p> <p>Stop: The fan will be stopped (default setting).</p> <p>Fan speed 1 / EC fan start speed: 3-speed fans will run at <i>Fan speed 1</i>. EC-fan will run at the set speed of <i>EC fan start speed (%)</i></p>

Figure 2-30 illustrates the 3-speed fan control behaviour in auto mode when no hysteresis for fan speed decrease is applied, the fan speed 1, 2, and 3 signals are configured on digital outputs 3, 4, and 5, and the *Demand for fan speed [nr] (%)* settings are set to 20, 60, and 100, respectively.

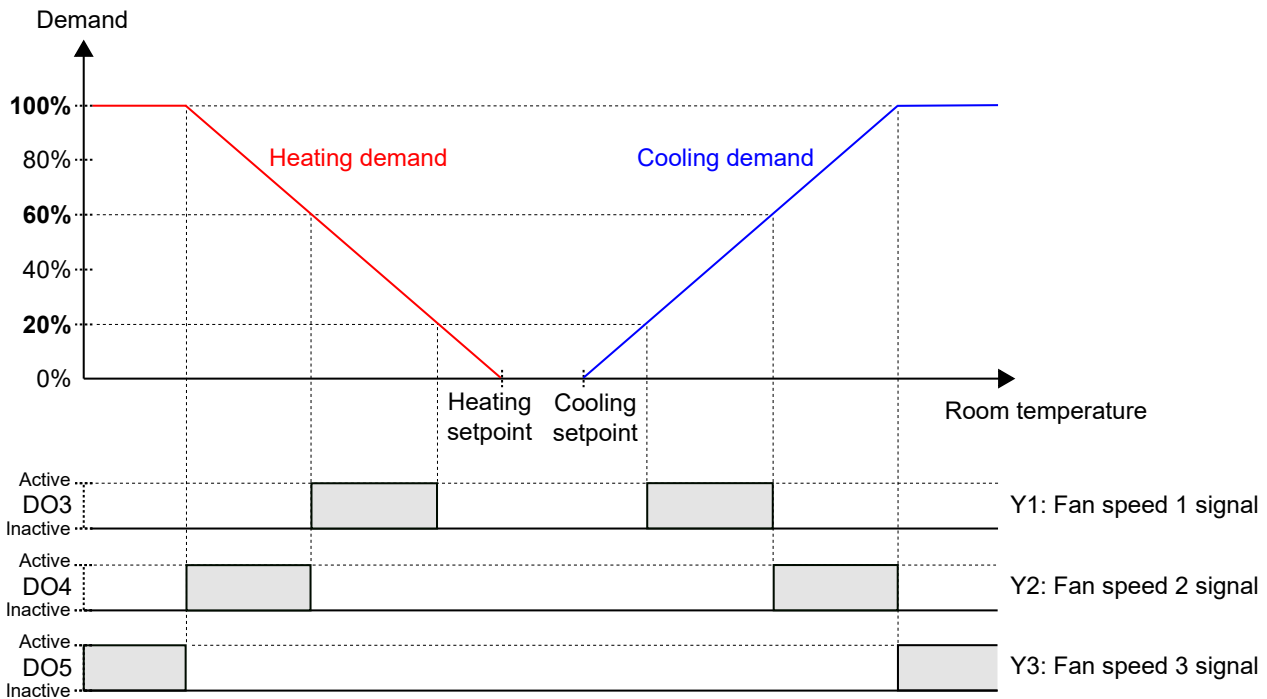

Figure 2-30 3-speed fan control behaviour in auto mode.

Figure 2-31 illustrates the 3-speed fan control behaviour in manual mode when the fan speed 1, 2, and 3 signals are configured on digital outputs 3, 4, and 5.

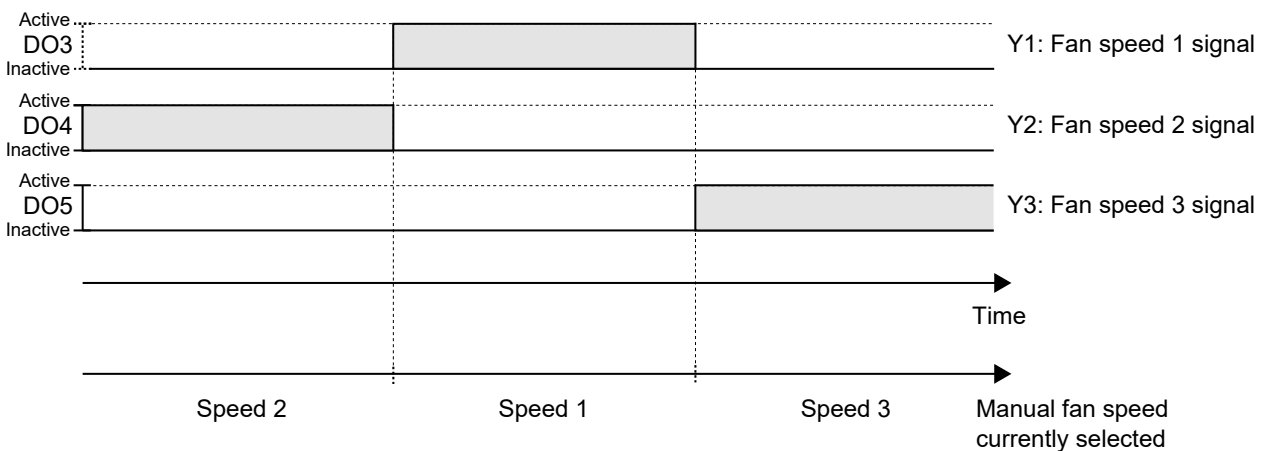

Figure 2-31 3-speed fan control behaviour in manual mode (fan speed 1, 2, or 3).

2.5.3 Fan boost

Fan boost is a control function that can be used to acknowledge to the person in the room that the fan is started when the occupancy (on/off) button in the room unit is pressed, or when the controller detects presence. This is useful when the initial heating or cooling demand is low (the difference between the room temperature and setpoint is small), since the fan then typically runs at a low speed.

Another use case for the fan boost function is to temporarily run the fan at an increased speed to provide a perceived cooling effect, until the cooling distribution from the cooling valve establishes.

The fan boost is achieved by the use of a separate fan boost controller that operates in parallel with the temperature controller, and temporarily increases the fan speed for a configured period of time (the fan boost time). P-band and I-time settings for the different controllers are located in the *Configuration -> Controller settings* pane in Application tool.

The fan boost function is enabled by configuring the *Fan boost time* setting to a value that is greater than zero.

The fan boost function is activated when presence is detected, see section 2.8, or when the controller changes to bypass state, see section 2.4. The fan boost time is independent of the *Time in bypass state* configuration setting.

When the fan boost function is active, the fan runs at maximum speed for the first 10 seconds of the fan boost time. For the remainder of the fan boost time, the fan speed output signal corresponds to whichever of the fan boost or temperature control signal that has the greatest value.

After the fan boost time has expired, the fan speed output signal corresponds to the temperature control signal, regardless if the fan boost control signal is greater than the temperature control signal. That is, the controller reverts to normal fan control, which is either auto or manual mode.

The fan boost configuration settings are described in *Table 2-19*.

Table 2-19 Fan boost configuration settings.

Configuration setting	Description
Fan boost mode	<p>At cooling demand: Fan boost is active at cooling demand.</p> <p>At heating demand: Fan boost is active at heating demand.</p> <p>At heating and cooling demand: Fan boost is active at both heating and cooling demand (default setting).</p>
Fan boost time (sec)	The period of time (in seconds) that the fan boost function is active.

Figure 2-32 illustrates how the fan boost function can be used to provide a perceived cooling effect until the cooling distribution from the cooling valve establishes.

In this example, the control behaviour for an EC fan in auto mode is described. It is assumed that the room temperature is 28 °C and the cooling setpoint is 24 °C at 0 seconds, resulting in an error value of 4, and that the error value is reduced to 0 at 300 seconds. The fan boost time is set to 90 seconds. The P-band for the fan boost controller is set to 5 °C, and the P-band and I-time for the temperature controller is set to 10 °C and 300 seconds, respectively.

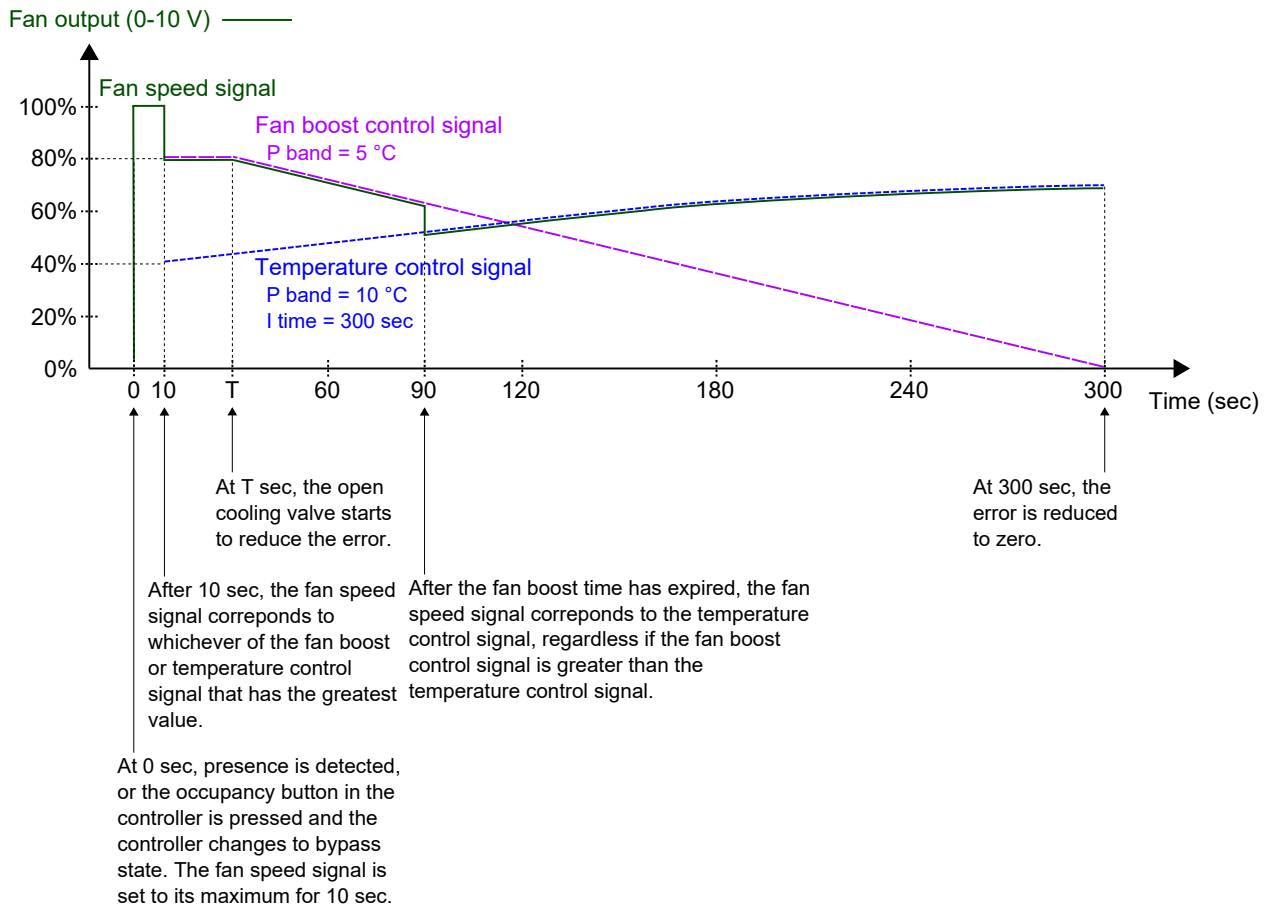

Figure 2-32 An example of fan boost control behaviour for an EC fan in auto mode, which provides a perceived cooling effect until the cooling distribution from the cooling valve establishes. The P-band for the fan boost controller has a lower value (higher gain) than the P-band for the temperature controller.

2.5.4 Fan kick-start

Fan kick-start is a control function that can be used to ensure that the EC fan starts even when the controller outputs a low-voltage control signal.

When using today's energy-saving EC fans, there is always a risk that the fan does not start due to a too low control voltage that prevents the fan from exceeding its starting torque. The fan then remains at a standstill while power still flows through it, which may cause damage to the fan. The fan kick-start function ensures that the fan output is at its maximum for a set period of time, thereby making sure that the starting torque is exceeded.

The fan kick-start function is enabled by configuring the *Fan kick-start time* setting to a value that is greater than zero.

The fan kick-start function is activated when the fan starts from standstill, in manual or auto mode.

When the fan kick-start function is active, the controller sets the fan speed output signal to its maximum for the period of time specified by the *Fan kick-start time* configuration setting.

After the fan kick-start time has expired, the controller reverts to normal fan control, that is, auto or manual mode.

The fan kick-start configuration settings are described in *Table 2-20*.

Table 2-20 Fan kick-start configuration settings.

Configuration setting	Description
Fan kick-start time (sec)	The period of time (in seconds) that the fan kick-start function is active.

2.5.5 Fan afterblow

Fan afterblow is a control function that can be used as a safety precaution when an electrical heating battery that is placed in the ductwork is used to provide heating. For example, when auto fan mode is in use and the heating demand decreases to zero, the fan stops while the electrical heating battery typically remains hot for a while longer. The fan afterblow function can then be used to make the fan run for an extended period of time to allow for the electrical heating battery to cool off.

The fan afterblow function is enabled via the *Fan afterblow mode* configuration setting.

The fan afterblow function is activated when the applicable heating output signal, as specified via the *Fan afterblow mode* configuration setting, decreases to zero.

When the fan afterblow function is active, the fan runs in afterblow mode for the period of time specified by the *Fan afterblow time* configuration setting. A minimum fan speed during fan afterblow can be set via the *Fan afterblow minimum speed* configuration setting.

After the fan afterblow time has expired, the controller reverts to normal fan control, that is, auto or manual mode.

The fan afterblow configuration settings are described in *Table 2-21*.

Table 2-21 Fan afterblow configuration settings.

Configuration setting	Description
Fan afterblow mode	<p>Off: Fan afterblow is disabled (default setting).</p> <p>After heating 1: Fan afterblow is activated when the heating output signal that is associated with heating sequence Y1 decreases to zero.</p> <p>After heating 2: Fan afterblow is activated when the heating output signal that is associated with heating sequence Y2 decreases to zero.</p> <p>After heating 1/2: Fan afterblow is activated both when the heating output signal that is associated with heating sequence Y1 or heating sequence Y2 decrease to zero.</p>
Fan afterblow minimum speed	<p>This setting is used to set a minimum fan speed during fan afterblow.</p> <p>Off: The minimum allowed fan speed is zero (default setting).</p> <p>Speed 1: The controller ensures that the minimum fan speed is the configured fan speed 1.</p> <p>Speed 2: The controller ensures that the minimum fan speed is the configured fan speed 2.</p> <p>Speed 3: The controller ensures that the minimum fan speed is the configured fan speed 3.</p>
Fan afterblow time (sec)	The period of time (in seconds) that the fan afterblow function is active.

2.6 VAV control

The variable air volume (VAV) control function is used to manage the behaviour for a damper that is controlled by the analog VAV output signal.

The VAV control function enables the controller to regulate based on:

- ✓ **Cooling demand**
The VAV output signal is controlled based on the cooling setpoint and the current room temperature.
- ✓ **Fresh air demand**
The VAV output signal is controlled based on the CO₂ setpoint and the current CO₂ level in the room.

✓ **Both cooling and fresh air demand simultaneously**

The highest demand determines if the VAV output signal currently is controlled based on the cooling setpoint and the room temperature, or the CO₂ setpoint and the CO₂ level in the room.

✓ **By min value**

The VAV output is fixed at the minimum output selected for the different controller states. It is not affected by the heat/cool control.

For information about CO₂ control, see section 2.10.

The maximum damper airflow can be controlled by setting a maximum limit on the VAV output signal. The minimum airflow that applies for each controller state can also be controlled by setting minimum limits on the VAV output signal.

The damper can also be controlled based on heating demand. This is useful when the heating device that provides the room with heat is located in the supply air duct and behind the damper that regulates the airflow into the room. When this function is active and the heating demand increases, the damper opens correspondingly and the distribution of heat into the room is boosted. This function is active when the *Max limit for VAV output at heating demand* configuration setting is greater than zero.

The VAV control function is enabled and the VAV control configuration settings in Application tool are shown when one of the following controller modes is selected:

- ✓ Heating + VAV
- ✓ Cooling + VAV
- ✓ VAV
- ✓ Heating + Cooling + VAV

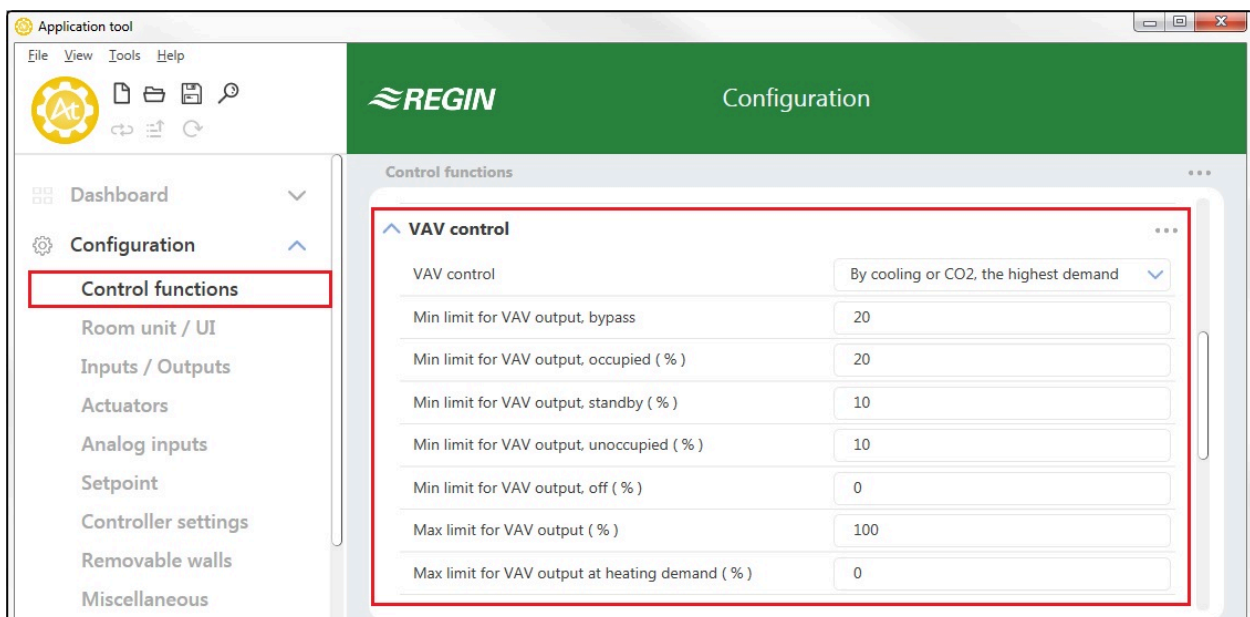

Figure 2-33 VAV control configuration settings in Application tool.

The VAV control configuration settings are described in Table 2-22.

Table 2-22 VAV control configuration settings.

Configuration setting	Description
VAV control	<p>By cooling demand: VAV control is performed based on cooling demand. The VAV output signal is controlled based on the cooling setpoint and the current room temperature.</p> <p>By CO2 demand: VAV control is performed based on fresh air demand. The VAV output signal is controlled based on the CO₂ setpoint and the current CO₂ level in the room.</p> <p>By cooling or CO2, the highest demand: VAV control is performed based on both cooling and fresh air demand simultaneously. The highest demand determines if the VAV output signal currently is controlled based on the cooling setpoint and the room temperature, or the CO₂ setpoint and the CO₂ level in the room (default setting).</p> <p>By min Value: VAV control is fixed at the minimum output selected for the different controller states. It is not affected by the heating/cooling control. ¹</p>
Min limit for VAV output, bypass (%) ¹	Specifies the minimum limit for the VAV output signal when the controller is in the bypass controller state. ¹
Min limit for VAV output, occupied (%)	Specifies the minimum limit for the VAV output signal when the controller is in the occupied controller state.
Min limit for VAV output, standby (%)	Specifies the minimum limit for the VAV output signal when the controller is in the standby controller state.
Min limit for VAV output, unoccupied (%)	Specifies the minimum limit for the VAV output signal when the controller is in the unoccupied controller state.
Min limit for VAV output, off (%)	Specifies the minimum limit for the VAV output signal when the controller is in the off controller state.
Max limit for VAV output (%)	Specifies the maximum limit for the VAV output signal.
Max limit for VAV output at heating demand (%)	<p>This setting is only applicable for the following controller modes:</p> <ul style="list-style-type: none"> ✓ Heating + VAV ✓ Heating + Cooling + VAV <p>When this value is greater than zero, the VAV output signal follows the heating output signal to a maximum that is specified by this value.</p>

1. Only available in Regio Eedo version 2.0-1-04 or later

Figure 2-34 illustrates the control behaviour for the Heating + VAV controller mode when VAV control is performed based on cooling demand, a maximum limit is set, and minimum limits for the occupied and unoccupied controller states are set.

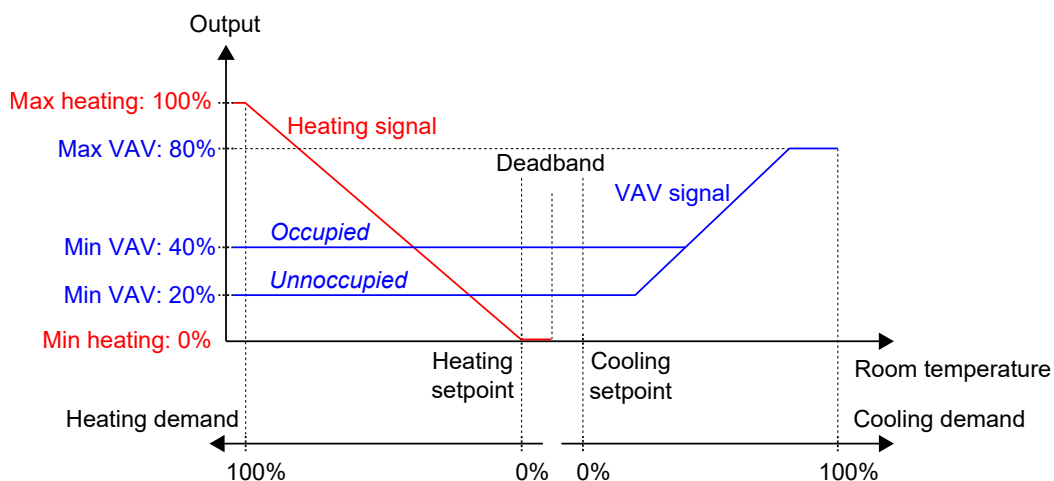

Figure 2-34 VAV control behaviour based on cooling demand when a maximum limit is set, and minimum limits for the occupied and unoccupied controller states are set.

Figure 2-35 illustrates the control behaviour for the Heating + VAV controller mode when the *Max limit for VAV output at heating demand* setting is applied. For example, when a 50% maximum is set, the VAV signal follows the heating signal as the heating demand increases but never exceeds 50% of its practical maximum (100%).

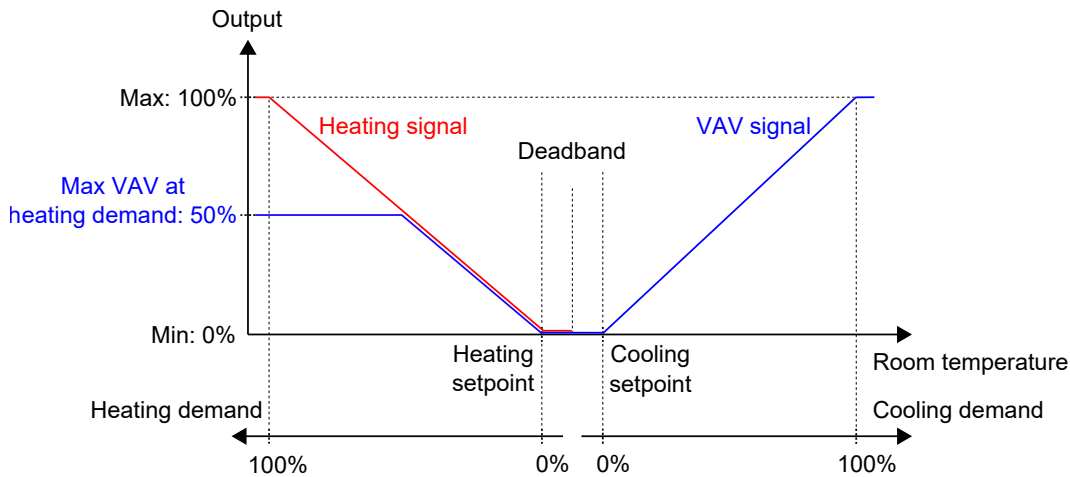

Figure 2-35 Control behaviour for the Heating + VAV controller mode when the maximum VAV output on heating demand setting is applied.

2.7 Forced ventilation

Forced ventilation is a control function that is used to improve the air quality in a room through increased airflow. This is achieved by fully opening the damper that regulates the airflow into the room, which provides an additional amount of fresh air and decreases the CO₂ level. The forced ventilation function can also be used to boost the heating or cooling distribution when the heating, cooling, or VAV output signal has reached its maximum.

The forced ventilation function can be used in all controller modes, and is enabled by applying the *Forced ventilation active* or *Forced ventilation active at max output* configuration settings, that is, changing them from their **Off** values.

The forced ventilation function is activated when the controller changes to bypass state and any of the conditions specified by the *Forced ventilation active* or *Forced ventilation active at max output* settings are fulfilled. See section 2.4 for information about bypass state.

When the forced ventilation function is active, a digital controller output that is configured with the **Forced ventilation** value is active, and the analog VAV output signal is set to its maximum for the controller modes that include a VAV sequence. Optionally, for the Cooling + VAV and Heating + Cooling + VAV controller modes, the cooling output signal can be configured to also be set to its maximum when the forced ventilation is active.

The forced ventilation configuration settings in Application tool are shown in *Figure 2-36*.

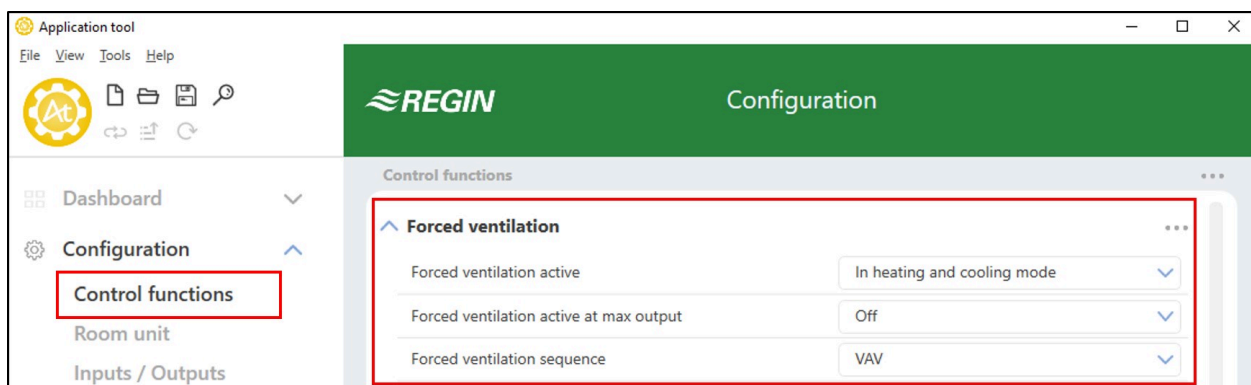

Figure 2-36 Forced ventilation configuration settings in Application tool.

The forced ventilation configuration settings are described in *Table 2-23*.

Table 2-23 Forced ventilation configuration settings.

Configuration setting	Description
Forced ventilation active	<p>This setting is used to select if forced ventilation should be activated when the controller is in heating or cooling mode, or in both modes. This is useful for providing an additional amount of fresh air into the room and for decreasing the CO₂ level.</p> <p>Off: Forced ventilation is not activated (default setting).</p> <p>In heating mode: Forced ventilation is activated when the controller is in heating mode and bypass state.</p> <p>In cooling mode: Forced ventilation is activated when the controller is in cooling mode and bypass state.</p> <p>In heating and cooling mode: Forced ventilation is activated both when the controller is in either heating or cooling mode, and in bypass state.</p>
Forced ventilation active at max output	<p>This setting is used to select if forced ventilation should be activated when the output signal is at its maximum. This is useful for providing a boosted heating or cooling effect when the heating, cooling, or VAV output signal have reached their maximum.</p> <p>Off: Forced ventilation is not activated (default setting).</p> <p>At max heating output: Forced ventilation is activated when the heating output signal is at its maximum and the controller is in bypass state.</p> <p>At max cooling/VAV output: Forced ventilation is activated when the cooling or VAV output signal is at its maximum and the controller is in bypass state.</p> <p>At max heating and cooling/VAV output: Forced ventilation is activated when the heating, cooling, or VAV output signal is at its maximum, and the controller is in bypass state.</p>
Forced ventilation sequence	<p>This setting is only applicable for the following controller modes:</p> <ul style="list-style-type: none"> ✓ Cooling + VAV ✓ Heating + Cooling + VAV <p>VAV: The VAV output signal is set to its maximum when the forced ventilation function is active (default setting).</p> <p>Cooling and VAV: Both the cooling and VAV output signals are set to their maximum when the forced ventilation function is active.</p>

Figure 2-37 illustrates the analog VAV output and digital output signal behaviour for the Heating + VAV controller mode when no maximum or minimum limits are set for the output signals, the controller is in bypass state, and the following configuration settings are applied:

- ✓ *Forced ventilation active:* **Off**
- ✓ *Forced ventilation active at max output:* **At max heating output**
- ✓ *Forced ventilation sequence:* **VAV**

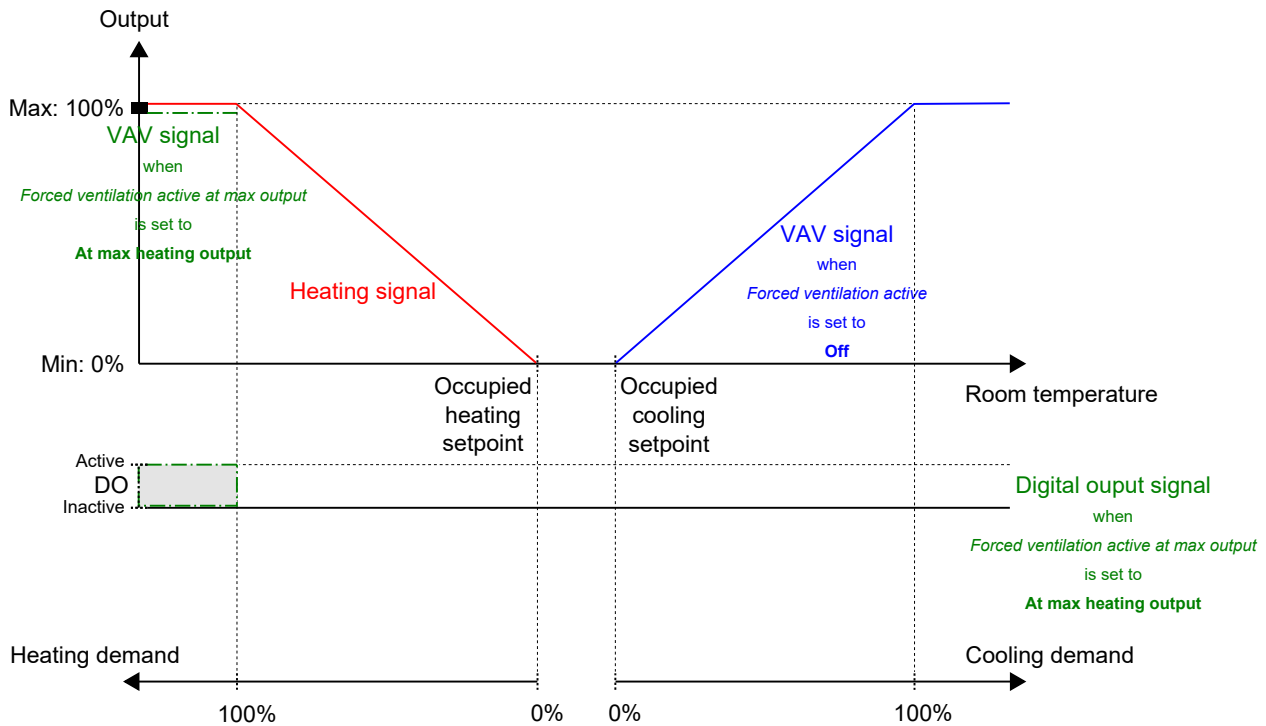

Figure 2-37 Example of forced ventilation control behaviour for the Heating + VAV controller mode when the controller is in bypass state.

Figure 2-38 illustrates the digital output signal behaviour for the Heating + Cooling controller mode when no maximum or minimum limits are set for the output signals, the controller is in bypass state, and the following configuration settings are applied:

- ✓ Forced ventilation active: **In cooling mode**
- ✓ Forced ventilation active at max output: **At max heating output**

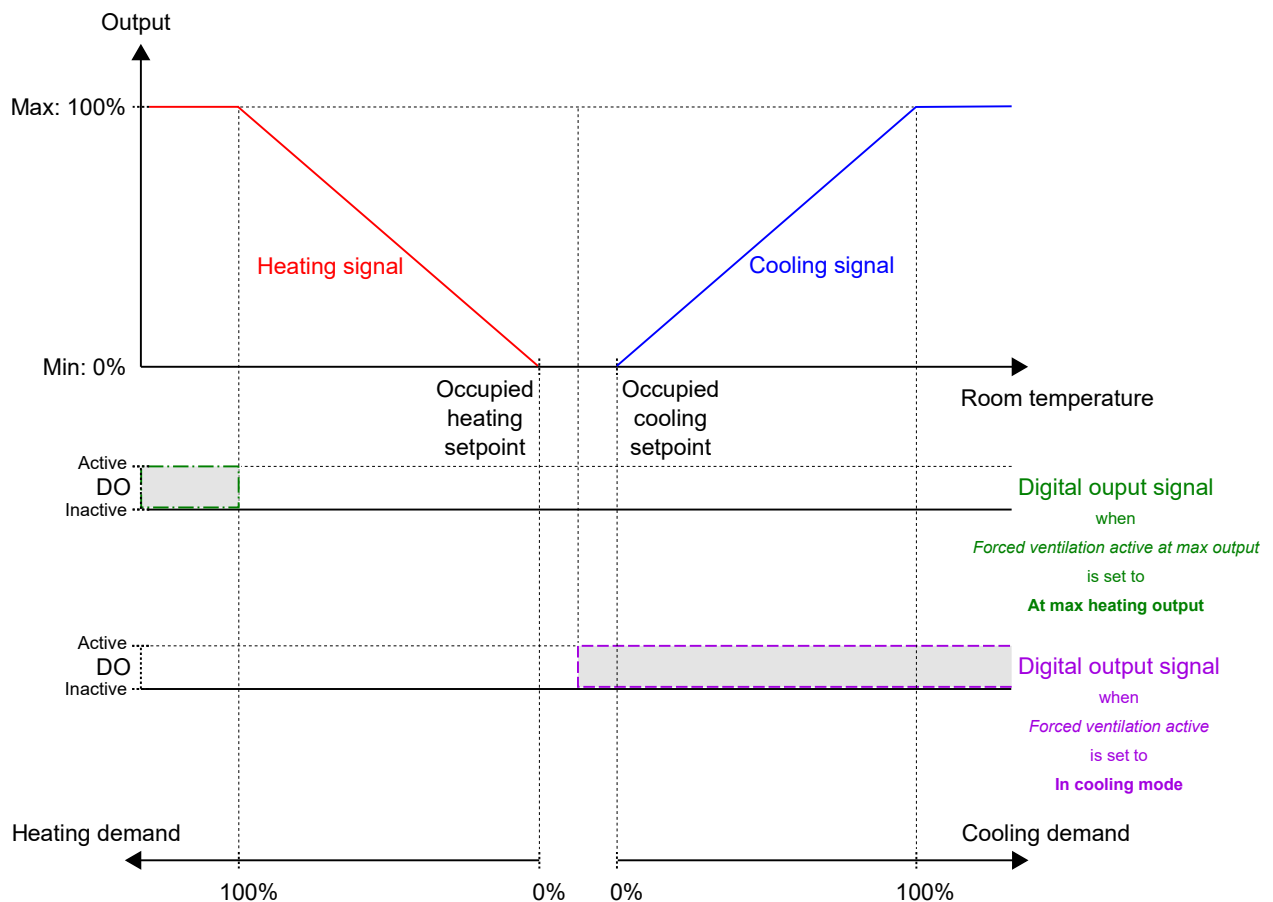

Figure 2-38 Example of forced ventilation control behaviour for the Heating + Cooling controller mode when the controller is in bypass state.

2.8 Presence detection

Presence detection is a control function that makes it possible for the controller to automatically switch between controller states based on if someone is present in the room, or if the CO₂ level in the room is too high. See section 2.4 for information about controller states, and controller state changes when using presence detection.

Presence detection is performed by using a presence detector, for example, a motion detector, that is connected to and configured on a digital controller input. Presence can also be detected by using a CO₂ sensor that measures the CO₂ level in the room, and is connected to and configured on an analog controller input. Regin's ED-RU-DOCS room unit has a built-in CO₂ sensor. When an ED-RU-DOCS room unit is connected, the controller recognizes the built-in CO₂ sensor automatically, and no controller input configuration is needed.

The controller checks for presence continuously when the controller is in the state specified by the *Preset controller state* setting, see section *Presence detection and occupancy (on/off) button on room unit*.

The presence detection function is enabled and the presence detection configuration settings are shown in Application tool when any of the configuration values listed in *Table 2-24* are configured on a controller input, or when an ED-RU-DOCS room unit is selected as connected room unit, see the *Configuration -> Room unit* pane in Application tool.

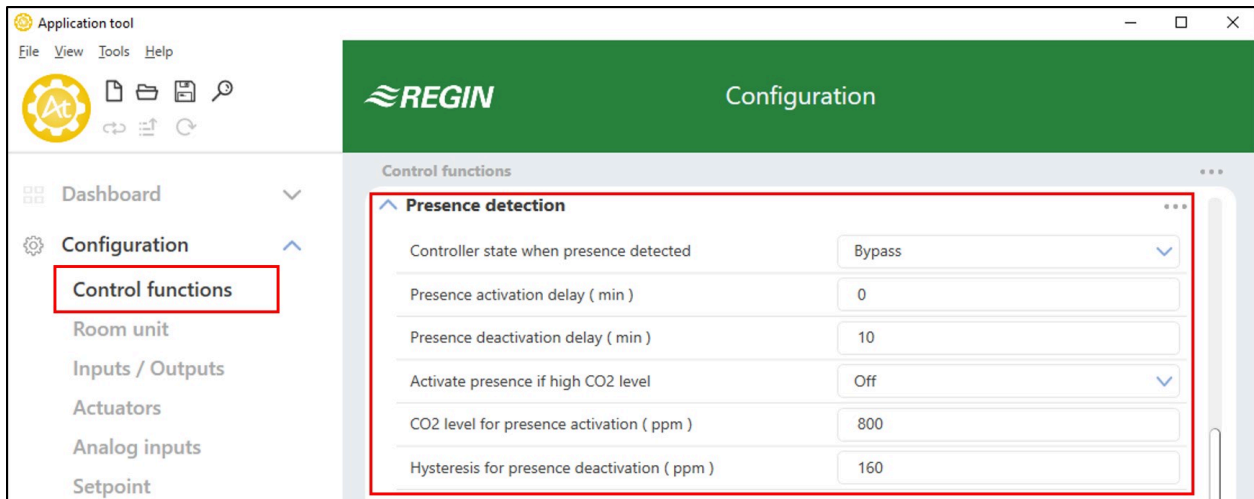

Figure 2-39 Presence detection configuration settings in Application tool.

Table 2-24 Presence detection configuration values and controller input types.

Controller input configuration value	Controller input type
CO2 sensor	Analog
Presence detector	Digital

The presence detection configuration settings are described in Table 2-25.

Table 2-25 Presence detection configuration settings.

Configuration setting	Description
Controller state when presence detected	One of the following controller states is configured as active when presence is detected: <ul style="list-style-type: none"> ✓ Occupied ✓ Bypass (default setting)
Presence activation delay (min)	The controller checks for presence continuously when the controller is in the state specified by the <i>Preset controller state</i> setting. When presence is detected, a timer starts and the controller waits this delay time (in minutes) before changing to the state specified by the <i>Controller state when presence detected</i> setting. If presence is not detected continuously during this delay time, for example, if a person leaves the room before the delay time has passed, the controller does not change to the presence detected controller state, and the timer is stopped and reset.
Presence deactivation delay (min)	The controller checks for presence continuously when the controller is in the presence detected controller state. When no presence is detected anymore, a timer starts and the controller waits this delay time (in minutes) before changing to the state specified by the <i>Preset controller state</i> setting. If presence is detected again during this delay time, for example, if a person re-enters the room before the delay time has passed, the controller stays in the presence detected controller state, and the timer is stopped and reset.
Activate presence if high CO2 level	Off: Presence detection via the CO ₂ sensor is disabled (default setting). On: Presence is detected via the CO ₂ sensor by using the <i>CO2 level for presence activation (ppm)</i> setting.
CO2 level for presence activation (ppm)	Presence is detected via the CO ₂ sensor when the measured CO ₂ level exceeds this value.
Hysteresis for presence deactivation (ppm)	Specifies the hysteresis for when presence is not detected via the CO ₂ sensor anymore. For example, if presence has been detected at 800 ppm and this setting is 160 ppm, the controller stops detecting presence at 800-160 = 640 ppm.

2.9 Communication heartbeat

The communication heartbeat function enables the controller to continue to regulate locally also if the communication to the SCADA system is lost. When the function is activated and there is a communication failure, the controller reverts to a preset controller state until the communication is reestablished. At that moment the controller resumes normal operation. The function will activate an alarm when there is a communication failure.



Note! When this function is activated the SCADA system has to reset the variable RegioCommFail-safe at a set timespan.

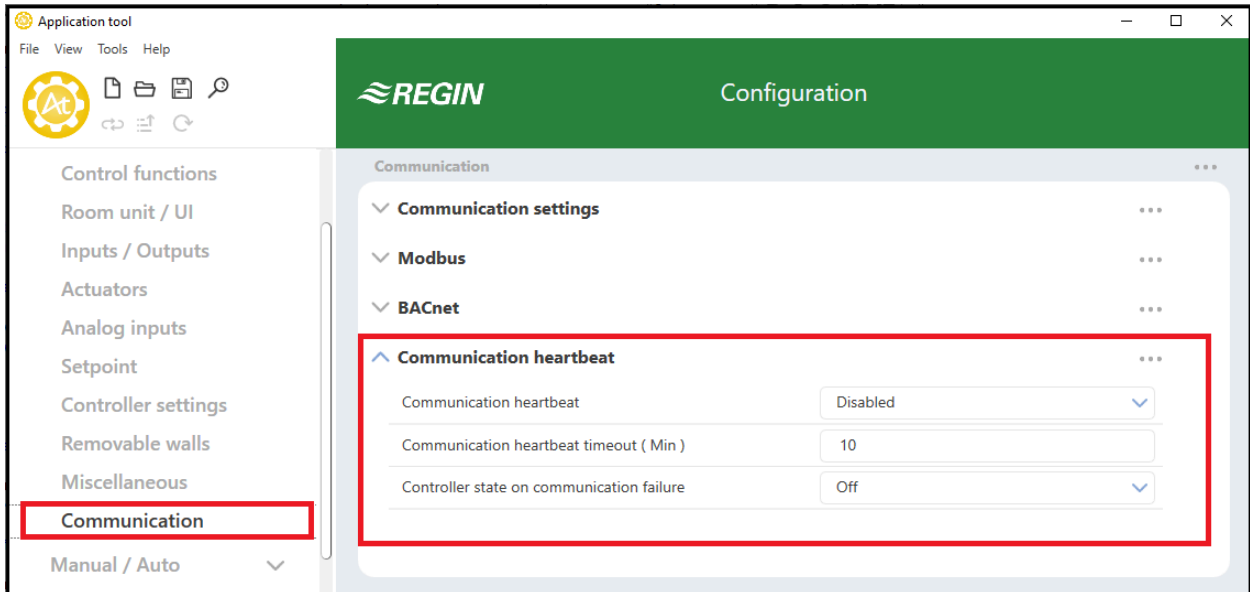

Figure 2-40 Communication heartbeat function in Application tool

The communication heartbeat configuration settings are described in Table 2-26.

Table 2-26 Configuration settings for communication heartbeat control

Configuration setting	Description
Communication heartbeat	Enabled: Activates the function Disabled: Inactivates the function (default setting)
Communication heartbeat timeout (Min)	The length, in minutes, between the communication is lost until the controller will start to regulate locally (default setting = 10 minutes) according to the preset state (Failure safe time in communication variables)
Controller state on communication failure	The state that the controller will revert to after the Failure safe time Off (default setting) Unoccupied Stand-by Occupied ByPass Keep current

2.10 CO₂ control

CO₂ control is a function that enables the controller to regulate based on fresh air demand. CO₂ control is performed by connecting a CO₂ sensor, and by letting the controller control the VAV output signal based on the CO₂ setpoint and the current CO₂ level in the room.

CO₂ control can be used together with the controller modes that include a VAV sequence:

- ✓ Heating + VAV
- ✓ Cooling + VAV
- ✓ VAV
- ✓ Heating + Cooling + VAV

CO₂ control is managed via the VAV control function, by applying the *VAV control* configuration setting, see section 2.6.

The CO₂ sensor is connected to and configured on an analog controller input by using the value listed in *Table 2-27*. Regin's ED-RU-DOCS room unit has a built-in CO₂ sensor. When an ED-RU-DOCS room unit is connected, the controller recognizes the built-in CO₂ sensor automatically, and no controller input configuration is needed.

Table 2-27 CO₂ control configuration value and controller input type.

Configuration value	Controller input type
CO2 sensor	Analog

CO₂ control provides a specific setting, listed in *Table 2-28*, that is only applicable for the controller modes that include a cooling sequence. This setting is located in the *Configuration -> Control functions -> Controller mode* pane in Application tool, and is shown when an applicable controller mode is selected.

Table 2-28 CO₂ control configuration setting.

Configuration setting	Description
Cooling sequence controlled by	<p>Cooling demand: The cooling output signal is controlled based on the cooling setpoint and the current room temperature (default setting).</p> <p>VAV control selection: The cooling output signal is controlled according to the <i>VAV control</i> setting, see section 2.6. That is, either by:</p> <ul style="list-style-type: none"> ✓ Cooling demand ✓ CO2 demand ✓ Cooling or CO2, the highest demand

Figure 2-41 illustrates the control behaviour for CO₂ control when a minimum limits is set for the VAV output signal.

The demand for fresh air increases as the CO₂ level in the room rises. When the CO₂ level rises above the CO₂ setpoint, *VAV signal* increases to respond to the fresh air demand. At 100% fresh air demand, *VAV signal* reaches its maximum.

When the CO₂ level in the room is lower than the CO₂ setpoint and no fresh air demand exists, *VAV signal* is at its minimum.

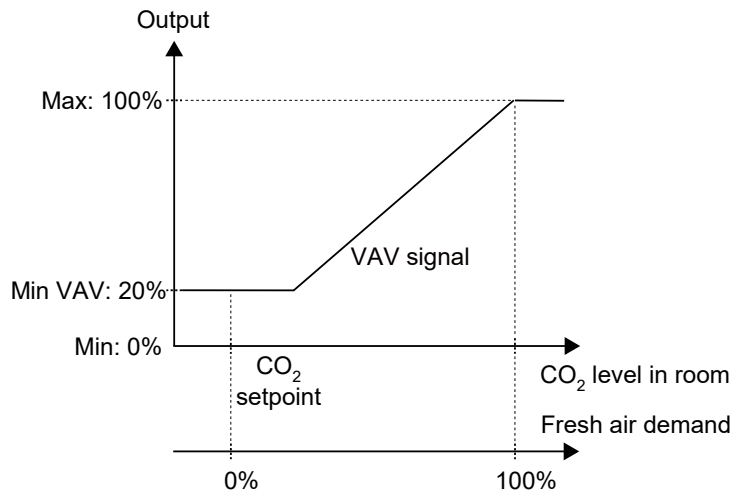

Figure 2-41 CO₂ control behaviour.

2.11 Extra zone control

This function is available in Regio^{Eedo} version 2.0-1-04 or later. The extra zone function is intended to control the underfloor heating in an extra zone, e.g. a bathroom, in parallel to the controlling main room. This means that the extra zone control runs with the same presence triggers as the main room, i.e. it always listens to the main room's control state and acts accordingly.

The extra zone control is activated when the main zone controller state is the same or higher than the selection in *Table 2-31 Extra zone configuration settings*. When the main zone is in cooling mode the extra zone heating can be disabled.

The extra zone acts as a heating controller and regulates based on its own heating setpoint and the extra zone temperature sensor.

The Digital output *Extra zone active signal* is corresponding to the *Activate Extra zone* configuration setting and doesn't require any *Extra zone temperature* sensor to work. It only indicates if the main room is in a selected control mode or higher.

However, an *Extra zone temperature* sensor can be used in order to regulate according to a set *Extra zone heating setpoint* (°C).

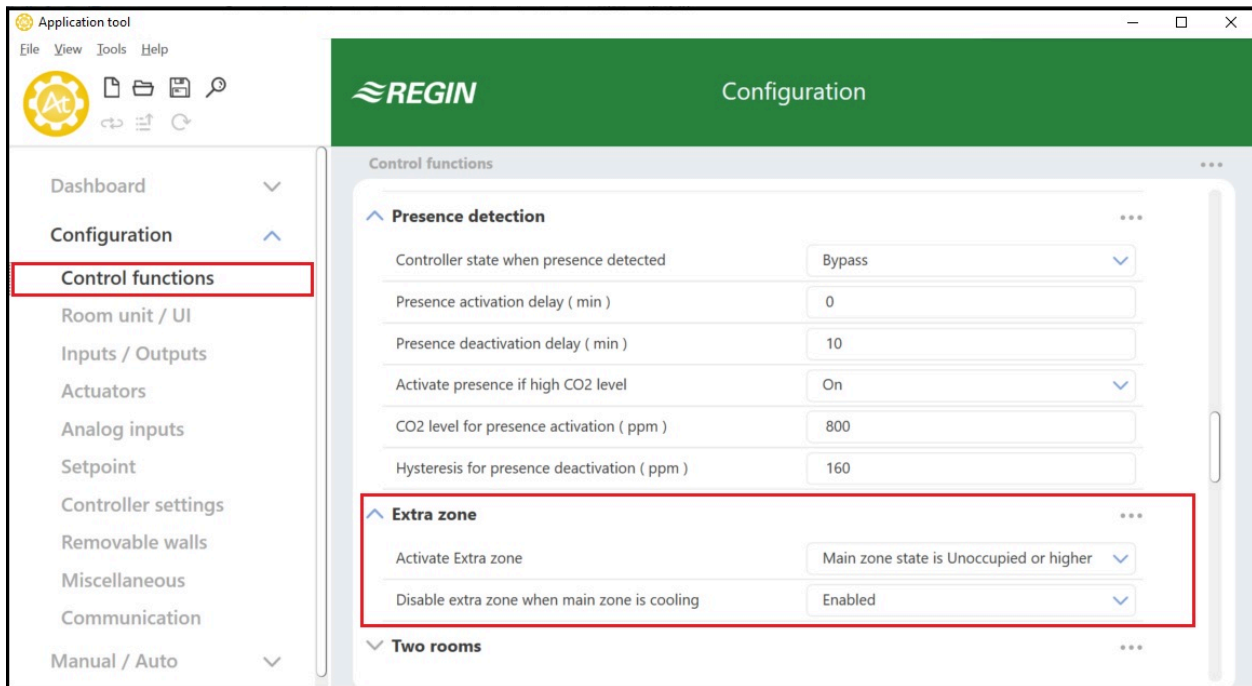

Figure 2-42 Extra zone configuration settings in Application tool.

Table 2-29 Controller input

Controller input configuration value	Controller input type
Extra zone temperature	Analog

Table 2-30 Controller output

Controller output configuration value	Controller output type
Extra zone heating valve, 0-10 V	Analog
Extra zone heating valve, thermal (PWM)	Digital
Extra zone active signal	Digital

The extra zone configuration settings are described in *Table 2-31*.

Table 2-31 Extra zone configuration settings.

Configuration setting	Description
Activate Extra zone	One of the following controller states is configured as active when presence is detected: Disabled (default setting) Main zone state is Unoccupied or higher Main zone state is Standby or higher Main zone state is Occupied or higher Main zone state is Bypass Always on
Disable extra zone when main zone is cooling	Disabled (default setting) Enabled



Note! The extra zone shares the valve exercise configuration with the main heating valve, thus it will exercise at the same day and for the same period of time.

3 Room unit

A person in the room can control the room's HVAC behaviour by using a room unit that is connected to the controller. A room unit, depending on the model, lets the person in the room:

- ✓ Put the room HVAC system in a comfort or energy saving mode
- ✓ Perform a setpoint adjustment
- ✓ Improve the air quality in the room through a temporary increase in airflow
- ✓ Select a fan speed
- ✓ Turn the room lighting on or off
- ✓ Control sun blinds

Room unit models with display can be used to perform basic controller configuration, see section 3.3.5, as an alternative to using Application tool.

A room unit, depending on the model, is also used to provide status information to the person in the room regarding:

- ✓ Controller state
- ✓ If the controller is heating or cooling
- ✓ Room temperature
- ✓ CO₂ level in room
- ✓ Setpoint adjustment
- ✓ Fan speed
- ✓ If a window is open
- ✓ If a sun blind is out
- ✓ If the room lighting is on
- ✓ Relative humidity level in room
- ✓ Outdoor temperature

3.1 Model overview and user interface description

The controller supports various Regin ED-RU... room unit models, that is, room units with or without:

- ✓ **LEDs or display**
For providing status information.
Models without display are equipped with LEDs that indicate the current controller state, and if the controller is heating or cooling. For models with display, all types of indications are provided in the display.
- ✓ **Occupancy (on/off) button**
For putting the room HVAC system in a comfort or energy saving mode, see section 2.4, or for improving the air quality in the room through a temporary increase in airflow (if forced ventilation is activated, see section 2.7).
- ✓ **Up/down buttons or knob**
For performing a setpoint adjustment.
- ✓ **Fan speed button or switch**
For selecting a fan speed. That is, auto speed or manual (off, low, medium, or high) speed.

✓ **Temperature and CO₂ sensor**

For measuring the temperature or CO₂ level in the room.

All models are equipped with a built-in temperature sensor, and the ED-RU-DOCS model includes a built-in CO₂ sensor.

✓ **Multi-function button**

For selecting a fan speed, controlling room lighting or sun blinds, or for viewing the outdoor temperature or relative humidity in the room.

Only the ED-RU-DOS model is equipped with the multi-function button.

The controller also support the touch screen room units ED-RUD and ED-RUD-2. When used with the Regio two room function, it is required to use two display units of the same kind, i.e. an ED-RUD / ED-RUD-2 can only be combined with another ED-RUD / ED-RUD-2 and not with any of the ED-RU... models.

Table 3-1 shows an overview of the features that the different room unit models provide.

Table 3-1 Room unit features per model.

Model	LEDs	Display	Occupancy (on/off) button	Up/down buttons for setpoint adjustment	Setpoint adjustment knob	Fan speed button	Fan speed switch	Temperature sensor	CO ₂ sensor	Multi-function button
ED-RU-H								✓		
ED-RU	✓				✓			✓		
ED-RU-F	✓				✓		✓	✓		
ED-RU-O	✓		✓		✓			✓		
ED-RU-FO	✓		✓		✓		✓	✓		
ED-RU-DO		✓	✓	✓				✓		
ED-RU-DFO		✓	✓	✓		✓		✓		
ED-RU-DOS		✓	✓	✓				✓		✓
ED-RU-DOCS		✓	✓	✓				✓	✓	
ED-RUD / ED-RUD-2		✓	✓	✓		✓		✓		

The room unit user interface is shown in Figure 3-1.

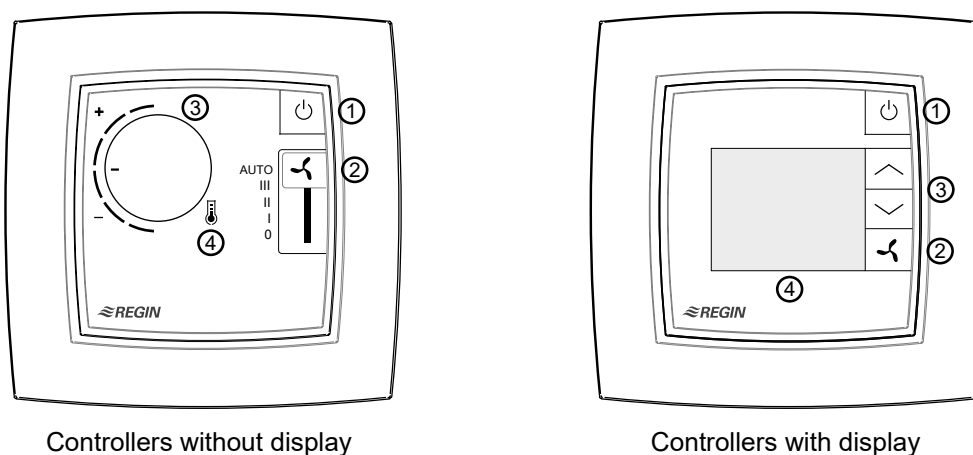

Figure 3-1 The ED-RU-FO room unit to the left and the ED-RU-DFO room unit to the right.

Table 3-2 describes the buttons, switch, knob, and LEDs that are available on room units with and without display.

Table 3-2 Button, switch, knob, and LED descriptions for room units with and without display.

Room units without display		Room units with display	
№	Description	№	Description
1	Occupancy (on/off) button with LED that indicates the controller state	1	Occupancy (on/off) button
2	Fan speed switch	2 (*)	Fan speed button (*Multi-function button on the ED-RU-DOS model, see section 3.3.8)
3	Setpoint adjustment knob	3	Up/down buttons for setpoint adjustment
4	LED in temperature icon that indicates if the controller is heating or cooling	4	Display

3.2 Room units without display

Figure 3-2 shows all the different room unit models without display.

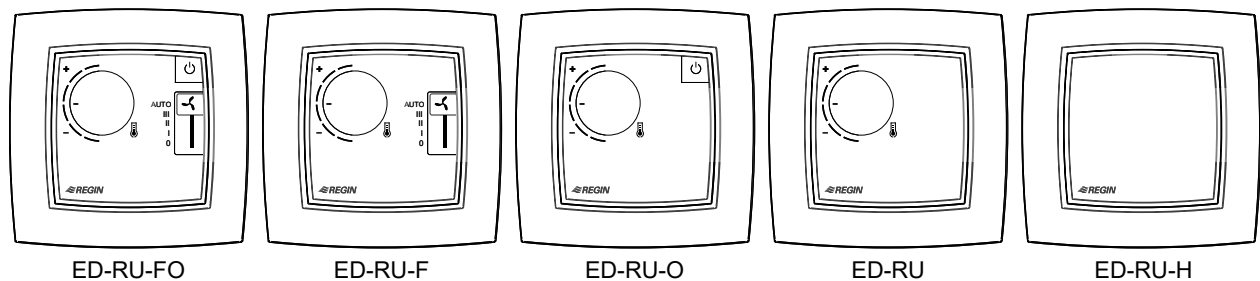

Figure 3-2 ED-RU... room unit models without display.

3.2.1 Selecting a fan speed

A fan speed is selected via the fan speed switch.

When the controller is in the state specified by the *Shutdown controller state* setting the fan speed is always auto, regardless of what is selected via the room unit.

3.2.2 Performing a setpoint adjustment

A setpoint adjustment is performed by turning the knob.

3.2.3 Putting the room HVAC system in a comfort/energy saving mode or increasing the airflow

A short press (<5 s) on the occupancy (on/off) button puts the room HVAC system in comfort mode (first in bypass controller state, and then by default in occupied controller state), and increases the airflow temporarily (if forced ventilation is activated).

A long press (>5 s) on the occupancy (on/off) button puts the room HVAC system in energy saving mode (by default in unoccupied controller state).

3.2.4 LED indications

The LEDs indicate the current controller state, and if the controller is heating or cooling. Table 3-3 describes the LED behaviour.

Table 3-3 LED indication descriptions.

LED location	LED behaviour
In occupancy (on/off) button	<p>Blinking slowly: The controller is in bypass state.</p> <p>Blinking: The controller is in standby state.</p> <p>Solid: The controller is in occupied state.</p> <p>Off: The controller is in unoccupied or off state.</p>
In temperature icon in the centre of the room unit	<p>Red solid: The controller is in heating mode and the demand is greater than zero.</p> <p>Blue solid: The controller is in cooling mode and the demand is greater than zero.</p> <p>Off: The demand is zero.</p>

3.3 Room units with display

Figure 3-3 shows all the different room unit models with display.

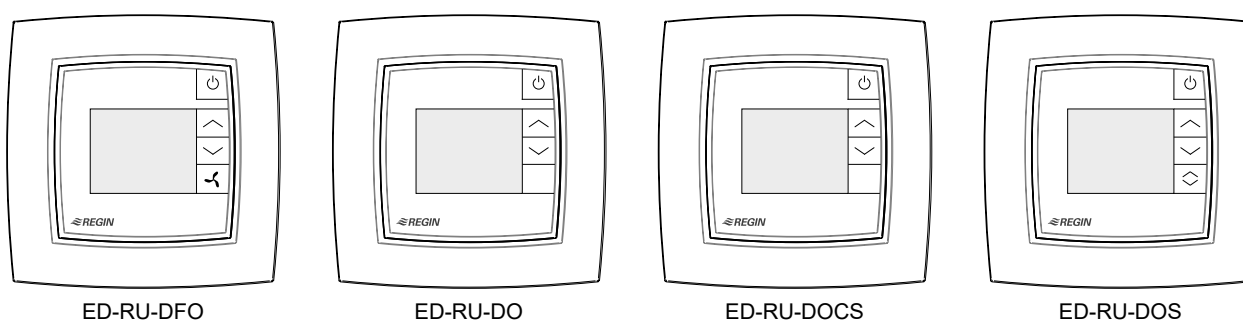

Figure 3-3 ED-RU... room unit models with display.

3.3.1 Selecting a fan speed

This instruction is only applicable for the ED-RU-DFO model. For information on selecting a fan speed on the ED-RU-DOS model, see section 3.3.8.

To select a fan speed:

1. Press the fan speed button to enter fan speed selection mode. The fan indication in the display starts to blink.
2. Press the fan speed button to scroll between the auto fan speed selection and the available (as configured in the controller) manual fan speed selections.
3. Press the occupancy (on/off) button to make the selection, or wait 10 seconds for the selection to be made automatically. After the selection has been made, the fan indication stops blinking.

When the controller is in the state specified by the *Shutdown controller state* setting the fan speed is always auto, regardless of what is selected via the room unit.

3.3.2 Performing a setpoint adjustment

For room units with display, a setpoint adjustment can be performed when the controller is in bypass, occupied, or standby state.

To perform a setpoint adjustment:

1. Press the up or down button to enter setpoint adjustment mode. The setpoint adjustment and up/down arrow indications in the display start to blink.
2. Press the up or down button to increase or decrease the setpoint adjustment, respectively. The selected setpoint adjustment value is shown in the display.

- Press the occupancy (on/off) button to make the selection, or wait 5 seconds for the selection to be made automatically. After the selection has been made, the setpoint adjustment and up/down arrow indications stop blinking.

3.3.3 Putting the room HVAC system in a comfort/energy saving mode or increasing the airflow

A short press (<5 s) on the occupancy (on/off) button puts the room HVAC system in comfort mode (first in bypass controller state, and then by default in occupied controller state), and increases the airflow temporarily (if forced ventilation is activated).

A long press (>5 s) on the occupancy (on/off) button puts the room HVAC system in energy saving mode (by default in unoccupied controller state).

3.3.4 Display indications

The display indications are shown in *Figure 3-4*.

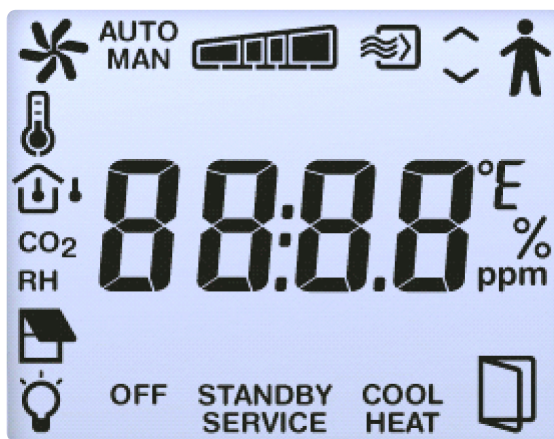

















Figure 3-4 Indications in room unit display.

The display indications are described in *Table 3-4*.

Table 3-4 Display indication descriptions.

Indication	Description
	Occupancy indication is shown when the controller is in occupied or bypass state.
STANDBY	Controller is in standby state.
OFF	Controller is in unoccupied or off state.
	Room temperature is shown.
CO2	CO ₂ level in room is shown.
	Solid: Setpoint or setpoint adjustment is shown (according to the current <i>View mode</i> setting, see section 3.7.3). Blinking: Setpoint adjustment is in progress by using the up and down buttons.
	Up/down arrows are blinking alternatively when setpoint adjustment is in progress.

Table 3-4 Display indication descriptions. (continued)

Indication	Description
	<p>Turning: The fan is active.</p> <p>Blinking: Fan speed selection is in progress.</p>
AUTO	<p>EC or 3-speed fan control in auto or manual mode. The fan speed is shown in the following ways:</p> <p>When 3 speeds is configured in the controller as number of used fan speeds, one of these indications is shown:</p> <div style="display: flex; justify-content: space-around; align-items: flex-end;"> <div style="text-align: center;">  No fan speed </div> <div style="text-align: center;">  Fan speed 1 </div> <div style="text-align: center;">  Fan speed 2 </div> <div style="text-align: center;">  Fan speed 3 </div> </div> <p>When 2 speeds is configured in the controller as number of used fan speeds, one of these indications is shown:</p>
MAN	<div style="display: flex; justify-content: space-around; align-items: flex-end;"> <div style="text-align: center;">  No fan speed </div> <div style="text-align: center;">  Fan speed 1 </div> <div style="text-align: center;">  Fan speed 2 </div> </div> <p>When 1 speed is configured in the controller as number of used fan speeds, one of these indications is shown:</p> <div style="display: flex; justify-content: space-around; align-items: flex-end;"> <div style="text-align: center;">  No fan speed </div> <div style="text-align: center;">  Fan speed 1 </div> </div>
HEAT	Controller is in heating mode and the demand is greater than zero.
COOL	Controller is in cooling mode and the demand is greater than zero.
	Forced ventilation is active.
SERVICE	Room unit is in service mode, in which the parameter menu can be accessed.
	Room window is open.
	Lighting is active.
	Sun blind is out.
RH	<p>Relative humidity level in room is shown temporarily.</p> <p>Note: Only the ED-RU-DOS model supports showing the relative humidity level in the display.</p>
	<p>Outdoor temperature is shown temporarily.</p> <p>Note: Only the ED-RU-DOS model supports showing the outdoor temperature in the display.</p>

3.3.5 Basic controller configuration via the display

Basic controller configuration can be performed via the parameter menu in room units with display. The room unit display parameters are listed in *Appendix B*.

The parameter menu is divided into the following groups:

- ✓ **CTRL** - Controller mode, setpoint, P-band, and I-time settings
- ✓ **SYS** - Controller state, change-over, presence detection, and lighting control settings
- ✓ **ACTR** - Actuator settings
- ✓ **FAN** - Fan control settings
- ✓ **M/AT** - Manual / Auto settings
- ✓ **HMI** - Room unit settings
- ✓ **IO** - Input / Output settings
- ✓ **ALAM** - Alarm settings

To access the parameter menu and set a parameter value:

1. Press the up and down buttons simultaneously, for about 5 seconds, until the **SERVICE** indication is shown in the display.
2. Press the up button twice to enter the parameter menu. The **CTRL** group heading is shown by default.
3. Use the up or down button to scroll to the applicable group heading, and then press the occupancy (on/off) button to access the parameters in the group.
4. Use the up or down button to scroll to the applicable parameter, and then press the occupancy (on/off) button to enter edit mode for the parameter.
5. Use the up or down button to select a parameter value, and then press the occupancy (on/off) button to set the selected value. During parameter value selection, the currently set value can be retrieved by pressing the up and down buttons simultaneously.

Back navigation in the parameter menu structure can be done in the following ways:

- ✓ Press the up and down buttons simultaneously.
- ✓ Use the up or down button to scroll to the **EXIT** value and then press the occupancy (on/off) button.

The display returns to normal view mode after 2 minutes of inactivity in the parameter menu.

3.3.6 Parameter menu access

Access to the parameter menu in room units with display can be disabled to prevent unauthorized users to perform basic controller configuration.

The configuration setting for disabling or enabling access to the parameter menu is listed in section 3.7.3.

3.3.7 Display background lighting

The display background is lit, and dimmed after 2 minutes of inactivity, when the controller is in:

- ✓ Bypass state
- ✓ The state specified by the *Preset controller state* setting
- ✓ The state specified by the *Controller state when presence detected* setting

The display background is not lit when the controller is in the state specified by the *Shutdown controller state* setting.

Configuration options for setting the display background brightness are listed in section 3.7.3.

3.3.8 ED-RU-DOS functions

ED-RU-DOS is a multipurpose room unit with display. In addition to having up/down buttons for setpoint adjustment and an occupancy (on/off) button for putting the room HVAC system in comfort or energy saving mode, this model is equipped with a multi-function button () that can be used for:

- ✓ **Selecting a fan speed** - auto fan speed or the available (as configured in the controller) manual fan speeds
- ✓ **Performing a setpoint adjustment** - increase or decrease
- ✓ **Temporarily viewing:**
 - ✓ Room and outdoor temperature
 - ✓ CO₂ level in the room
 - ✓ Relative humidity in the room
- ✓ **Controlling sun blinds** - send in/out or stop
- ✓ **Controlling room lighting** - turn on/off

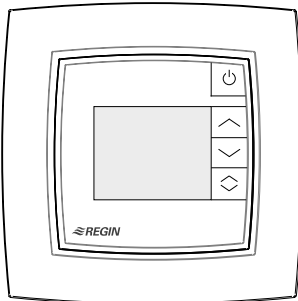



Figure 3-5 ED-RU-DOS room unit.

To perform an action in the multi-function menu:

1. Press  to scroll between the items in the multi-function menu. The current item blinks.
2. Press the up or down button to modify the value for current item.
3. Press the occupancy (on/off) button to select the modified value, or wait 10 seconds for the selection to be made automatically. After the selection has been made, the display returns to normal view mode.

When the controller is in the state specified by the *Shutdown controller state* setting the fan speed is always auto, regardless of what is selected via the room unit.

3.4 Communication LED

An LED is located inside the lower right corner of the room unit and blinks when the room unit is communicating with the controller.

The blinking is visible when the frame on top of the room unit is removed, and the room unit is communicating.

3.5 Enable or disable buttons/switch and knob

The buttons, fan switch, and setpoint adjustment knob on the room unit can be enabled or disabled in different ways to restrict end-user control. Note that the parameter menu in room units with display is accessible even if the up/down buttons are not enabled.

Configuration options for enabling or disabling buttons, the fan switch, or the setpoint adjustment knob are listed in section 3.7.3 *Display and buttons*.

3.6 Wiring

For information on how to wire the ED-RU... unit and connect it to the controller, see section 6.

3.7 Configuration settings

The room unit configuration settings are described in the following sections.

3.7.1 General

This section describes the general configuration settings.

Table 3-5 General configuration settings.

Configuration setting	Description
Connected room unit	<p>The room unit model that is used in the room HVAC system:</p> <ul style="list-style-type: none"> ✓ None ✓ ED-RU ✓ ED-RU-O ✓ ED-RU-F ✓ ED-RU-FO ✓ ED-RU-DO ✓ ED-RU-DFO ✓ ED-RU-DOS ✓ ED-RU-H ✓ ED-RU-DOCS ✓ ED-RUD (Modbus) <p>This setting is used for configuration purposes, that is, for displaying relevant configuration settings in Application tool that are related to the specific room unit model.</p>
Room unit ELA	<p>Specifies the room unit ELA or Modbus address that the controller uses for communication with the room unit.</p> <p>The ELA address has the format 1:[1-30] and is printed on a label that is located on the back of the room unit PCB.</p> <p>0: The controller automatically identifies the ELA address of the connected room unit (default setting).</p> <p>1, 2, 3...28, 29, 30: The controller only communicates with a connected room unit that has this ELA address.</p>
Reset user settings on shutdown ¹	<p>Disabled: No user settings are reset (default setting)</p> <p>Enabled: All manual inputs in the room unit are reset when the controller changes to the controller state defined as Shutdown Control state.</p> <p>It is only recommended to use this setting on room units with display, else there will be a difference in value between the room unit and the controller until a new change is made by a user.</p>

1. Only available in Regio Eedo version 2.0–1–04 or later.

3.7.2 Max setpoint adjustment

This section describes the max setpoint adjustment configuration settings.

Table 3-6 Max setpoint adjustment configuration settings.

Configuration setting	Description
Max setpoint adjustment up (°C)	Specifies the maximum allowed setpoint adjustment up.
Max setpoint adjustment down (°C)	Specifies the maximum allowed setpoint adjustment down.

3.7.3 Display and buttons

This section describes the display and buttons configuration settings.

Table 3-7 Configuration settings.

Configuration setting	Description
Occupancy button press time for shutdown controller state (s)	The period of time (in seconds) that the occupancy button must be pressed (long press) for the controller to change to the state specified by the <i>Shutdown controller state</i> setting.
Fan button behaviour	Manual mode: Manual fan control (default setting) Forced ventilation: Activates forced ventilation
View mode	One of the following options is selected: <ul style="list-style-type: none"> ✓ Temperature: The room temperature is shown (default setting). ✓ Heating setpoint: The occupied heating setpoint, including setpoint adjustment, is shown. ✓ Cooling setpoint: The occupied cooling setpoint, including setpoint adjustment, is shown. ✓ Average of cooling and heating setpoint: The average of the occupied cooling and heating setpoint, including setpoint adjustment, is shown. ✓ Setpoint adjustment: The setpoint adjustment is shown. ✓ CO2 level: The CO₂ level in the room is shown.
View mode during setpoint adjustment	One of the following options is selected: <ul style="list-style-type: none"> ✓ Setpoint adjustment: The setpoint adjustment is shown (default setting). ✓ Controlling setpoint: The occupied heating or cooling setpoint, including setpoint adjustment, that is used for control is shown. ✓ Heating setpoint: The occupied heating setpoint, including setpoint adjustment, is shown. ✓ Cooling setpoint: The occupied cooling setpoint, including setpoint adjustment, is shown.
Alternate between view mode setting and CO ₂ level	Enabled: The display alternates between showing the current <i>View mode</i> setting and the CO ₂ level in the room (default setting). Disabled: The current <i>View mode</i> setting is shown.
Brightness when lit (%)	Specifies the display background brightness when lit.
Brightness when dimmed (%)	Specifies the display background brightness when dimmed. The brightness is dimmed after 2 minutes of inactivity.
Enabled buttons/switch and knob	One of the following options is selected: <ul style="list-style-type: none"> ✓ All disabled ✓ Occupancy button ✓ Fan button/switch ✓ Up/down buttons, knob ✓ Occupancy button, up/down buttons, knob ✓ Fan button/switch, up/down buttons, knob ✓ All enabled (default setting) Note: The parameter menu in room units with display is accessible even if the up/down buttons are not enabled.
Parameter menu access	Enabled: The parameter menu is accessible (default setting). Disabled: The parameter menu is not accessible.

4 Inputs / Outputs

4.1 General configuration

The controller inputs and outputs are configurable. *Figure 4-1* shows the *Inputs / Outputs* pane in Application tool.

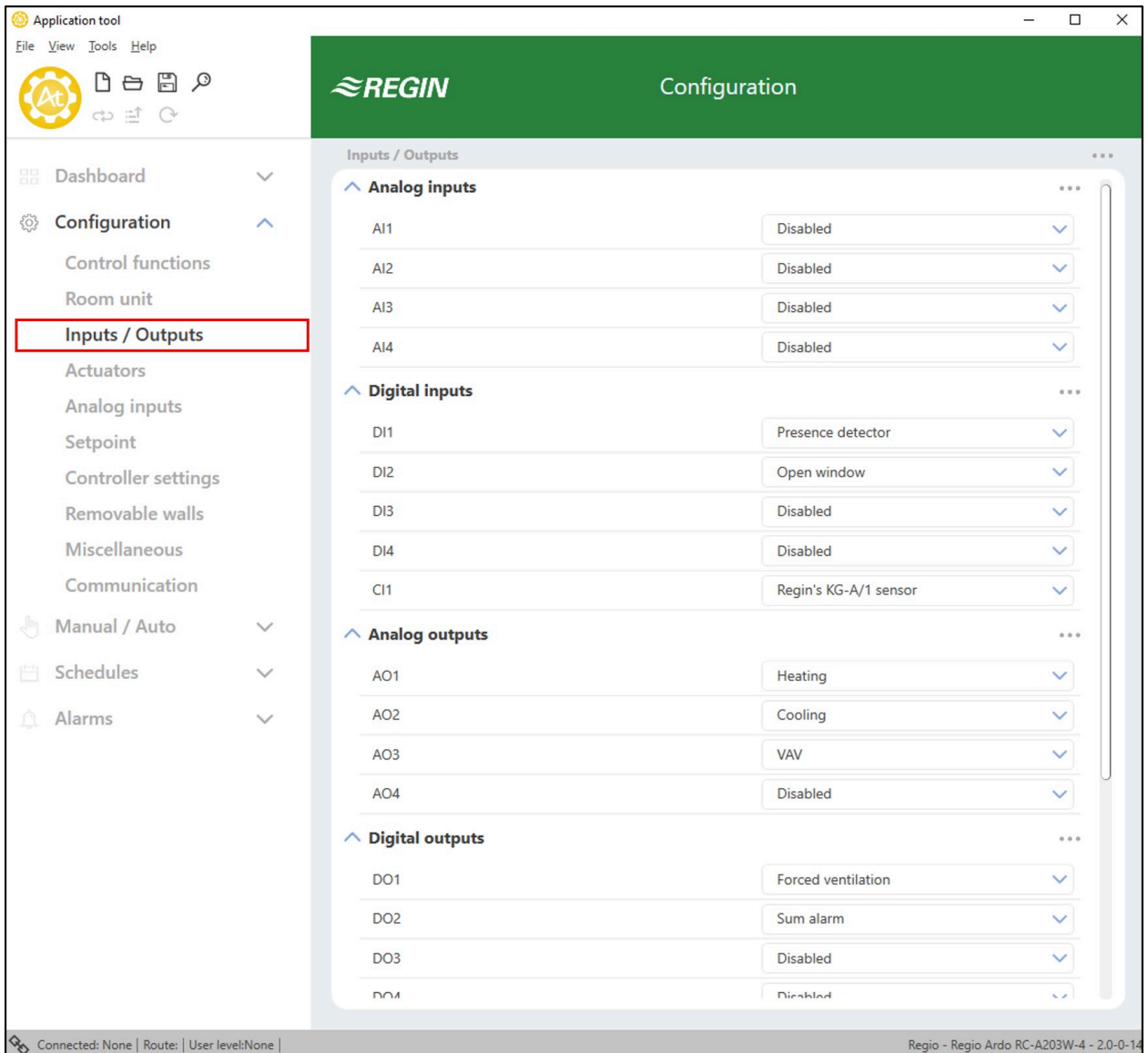

Figure 4-1 Controller input and output configuration in Application tool.

Table 4-1 provides an overview of the controller inputs and outputs, and lists their configuration options.

Table 4-1 Controller inputs and outputs, and their configuration options.

Input or output	Type	Configuration value options
AI1	Analog input, AIc	<ul style="list-style-type: none"> ✓ Disabled ✓ External room temperature ✓ Change-over temperature ✓ Outdoor temperature ✓ Supply air temperature ✓ Extra zone temperature¹ ✓ Ext. Analog Input PT1000 ¹
AI2 AI3	Analog input, AIb	<ul style="list-style-type: none"> ✓ Disabled ✓ Condensation sensor ✓ CO2 sensor ✓ RH sensor ✓ External room temperature 0-10 V² ✓ Flow sensor ² ✓ Ext. Analog Input 0-10 V ¹
DI1 DI2 DI3	Digital input, DIb	<ul style="list-style-type: none"> ✓ Disabled ✓ Open window ✓ Presence detector ✓ Change-over
CI1	Digital input, CIa	<ul style="list-style-type: none"> ✓ Disabled ✓ Regin's KG-A/1 sensor
AO1 AO2 AO3 AO4	Analog output, AOa	<ul style="list-style-type: none"> ✓ Disabled ✓ Heating ✓ Heating 2 ✓ Cooling ✓ Change-over valve ✓ 6-way valve ✓ VAV ✓ EC fan
DO1 DO2	Digital output, DOd	<ul style="list-style-type: none"> ✓ Disabled ✓ Lighting ✓ Blind in ✓ Blind out ✓ Forced ventilation ✓ Heating valve, increase ✓ Heating valve, decrease ✓ Heating valve, thermal (PWM) ✓ Heating valve 2, increase ✓ Heating valve 2, decrease ✓ Heating valve 2, thermal (PWM) ✓ Cooling valve, increase ✓ Cooling valve, decrease ✓ Cooling valve, thermal (PWM) ✓ Change-over valve, increase ✓ Change-over valve, decrease ✓ Change-over valve, thermal (PWM) ✓ 6-way valve, increase ✓ 6-way valve, decrease ✓ Sum alarm ✓ Sum alarm A ✓ Sum alarm B ✓ Heating valve extra zone, thermal (PWM) ¹ ✓ Extra zone active signal ¹
DO3 DO4 DO5	Digital output, DOc	<ul style="list-style-type: none"> ✓ Disabled ✓ Fan speed 1 ✓ Fan speed 2 ✓ Fan speed 3

1. Only available in Regio Eedo version 2.0-1-04 or later

2. Only available in Regio Eedo version 2.0-1-05 or later

4.2 Input control

External sensor inputs that are not connected to any central loop or room can be read and configured by a SCADA system. This is enabled by selecting one of the corresponding configuration value options in Application tool.

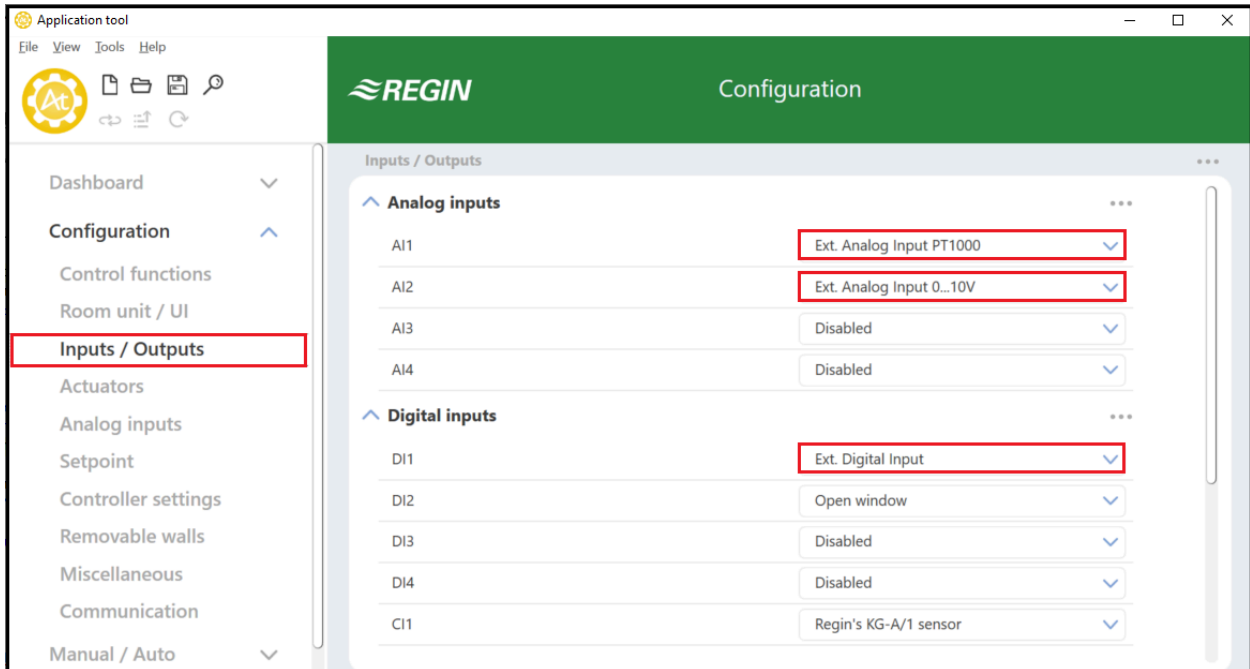

Figure 4-2 Controller input configuration in Application tool

Table 4-2 Configuration options for SCADA controlled inputs

Configuration setting	Configuration options
AI	Ext. Analog Input PT1000 Ext. Analog Input 0...10V
DI	Ext. Digital Input

4.3 Output control

When the outputs are configured for manual configuration it is possible to control the outputs in the controller via the SCADA system. The controller outputs are configured in the *Hardware control* pane in Application tool (see Figure 4-3).

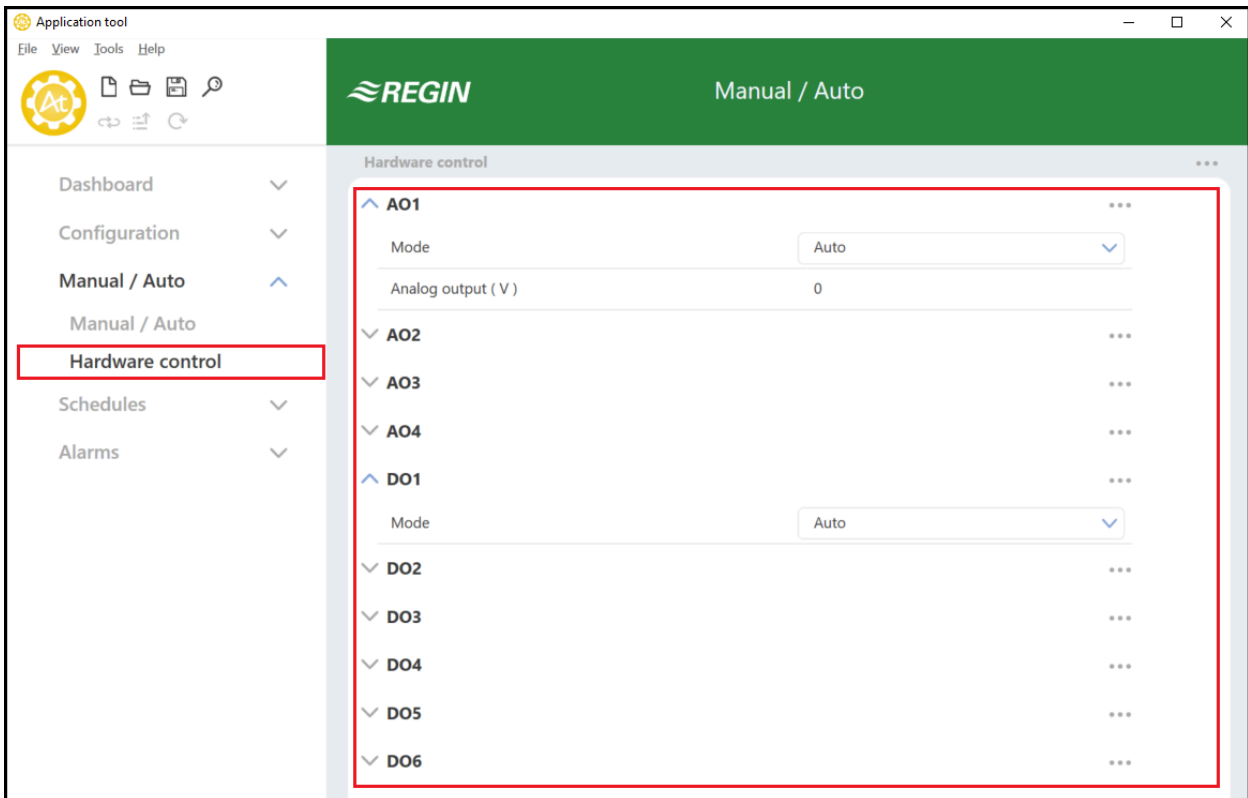

Figure 4-3 Hardware output configuration in Application tool

The possible configuration options to enable SCADA controlled outputs are shown in Table 4-3

Table 4-3 Configuration options for SCADA controlled outputs

Configuration setting	Configuration options
AO Mode	<ul style="list-style-type: none"> ✓ Manual - Off: The AO is off ✓ Manual - Set value: The AO is set to a fixed value ✓ Auto: The AO runs in Auto mode
AO Set value (V)	The output value when in Set value mode
DO Mode	<ul style="list-style-type: none"> ✓ Manual - Off: The DO is off ✓ Manual - On: The DO is on ✓ Auto: The DO runs in Auto mode

5 Setpoint

Different setpoint and deadband settings are used by the different controller states, see section 2.4, to regulate the heating and cooling distribution. *Figure 5-1* shows the setpoint and deadband configuration settings in Application tool.

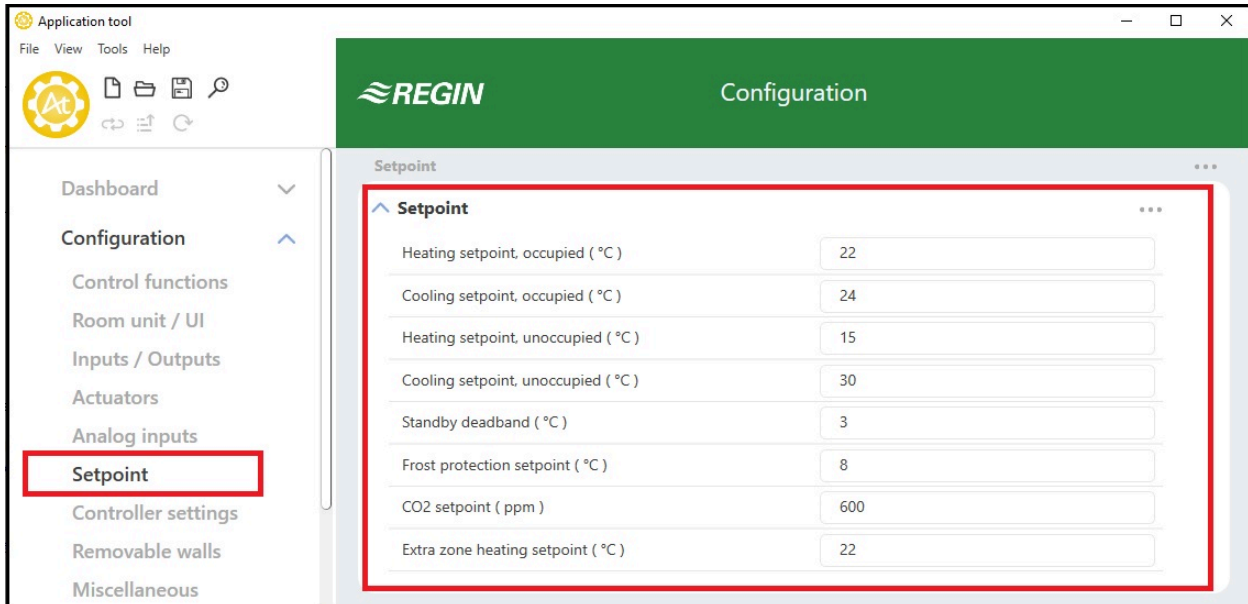

Figure 5-1 Setpoint and deadband configuration settings in Application tool.

An overview of the setpoint and deadband configuration settings are provided in *Table 5-1*.

Table 5-1 Setpoint and deadband settings overview.

Configuration setting	Controller state applicability
Heating setpoint, occupied (°C)	✓ Standby
Cooling setpoint, occupied (°C)	✓ Occupied ✓ Bypass
Heating setpoint, unoccupied (°C)	✓ Unoccupied
Cooling setpoint, unoccupied (°C)	
Standby deadband (°C)	✓ Standby
Frost protection setpoint (°C)	✓ Off
CO2 setpoint (ppm)	✓ Unoccupied ✓ Standby ✓ Occupied ✓ Bypass
Extra zone heating setpoint (°C)	The extra zone setpoint, in °C

5.1 Active setpoint

The active setpoint is the setpoint value currently being used for control. The active setpoint is determined by:

- ✓ The current controller state in use.
- ✓ The configured setpoint and deadband settings.

-
- ✓ Any applied setpoint adjustment. Note that setpoint adjustment is not active in certain controller states.

See section 2.4.1 for descriptions of the control behaviour for the controller states, including how the active heating and cooling setpoints are defined in each controller state.

5.2 Setpoint adjustment

The active setpoint can be raised or lowered by performing a setpoint adjustment. A setpoint adjustment is performed via the setpoint knob or the buttons on the room unit, or via communication.

A setpoint adjustment shifts both the active heating and cooling setpoints by equal measure. For example, if a +1 °C setpoint adjustment is applied, both the active heating and cooling setpoint are raised by +1 °C.

Maximum limits (up and down) for the setpoint adjustment can be set via configuration, see the *Configuration -> Room unit* pane in Application tool.

6 Controller connections and wiring diagrams

The controller connections are shown in *Figure 6-1* and described in *Table 6-1*.

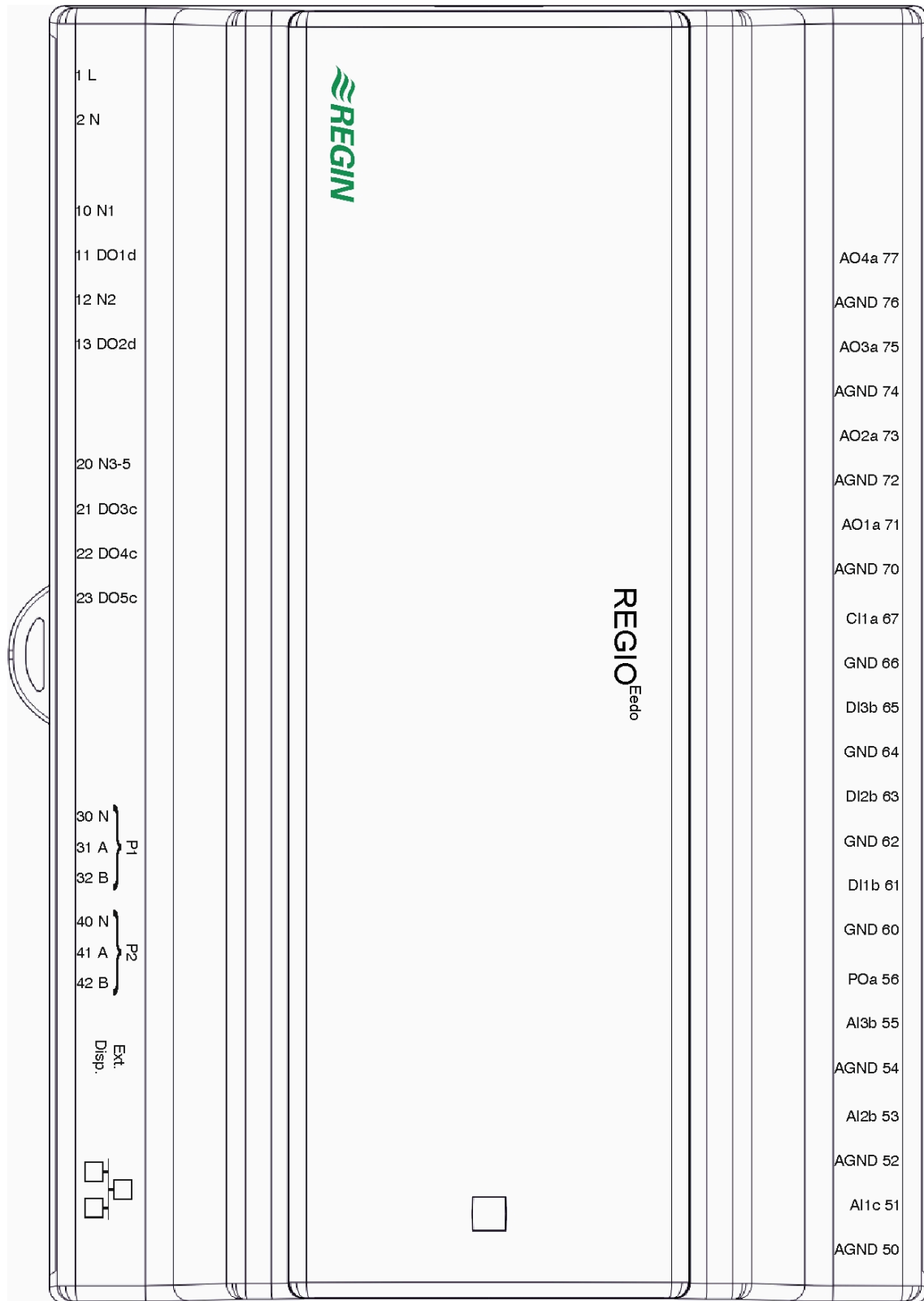



Figure 6-1 Controller connections layout.

Table 6-1 Controller connection descriptions.

Terminal № and designator	Type	Description
1 L	Supply voltage	230 V AC supply voltage.
2 N	Supply voltage (neutral)	230 V AC supply voltage (neutral).
10 N1 12 N2 20 N3-5	Neutral	Digital output neutral.
11 DO1d 13 DO2d	Digital output	Triac output used for valve, blinds, or lighting control, or for alarms or forced ventilation.
21 DO3c 22 DO4c 23 DO5c	Digital output	Relay output used for 3-speed fan control.
30 N 31 A 32 B	RS485 communication port	RS485 connector used for communication via BACnet, Exoline or Modbus. N can be used as common signal reference if a large difference in potential between units in the network is causing communication problems. This connection is galvanically isolated.
40 N 41 A 42 B	RS485 communication port	RS485 connector used for communication via BACnet, Exoline or Modbus. N can be used as common signal reference if a large difference in potential between units in the network is causing communication problems. This connection is not galvanically isolated.
Ext. Disp.	External display communication port	4P4C modular connector used for communication with an ED-RU... room unit.
	Ethernet communication port	8P8C modular connector used for Ethernet - TCP/IP communication.
50 AGND 52 AGND 54 AGND 70 AGND 72 AGND 74 AGND 76 AGND	Analog ground	Signal ground for analog inputs and outputs.
51 AI1c	Analog input	Input used for change-over detection or for temperature sensor.
53 AI2b 55 AI3b	Analog input	Input used for CO ₂ , condensation, or relative humidity sensor.
56 POa	Power output	24 V DC supply voltage output used for powering a CO ₂ or condensation sensor.
60 GND 62 GND 64 GND 66 GND	Digital ground	Signal ground for digital inputs.
61 DI1b 63 DI2b 65 DI3b	Digital input	Input used for presence, open window, or change-over detection.
67 C1a	Condensation input	Input dedicated for Regin's condensation detector KG-A/1.
71 AO1a 73 AO2a 75 AO3a 77 AO4a	Analog output	Output used for valve, damper, or EC fan control.

The wiring diagram in *Figure 6-2* exemplifies controller connections usage.

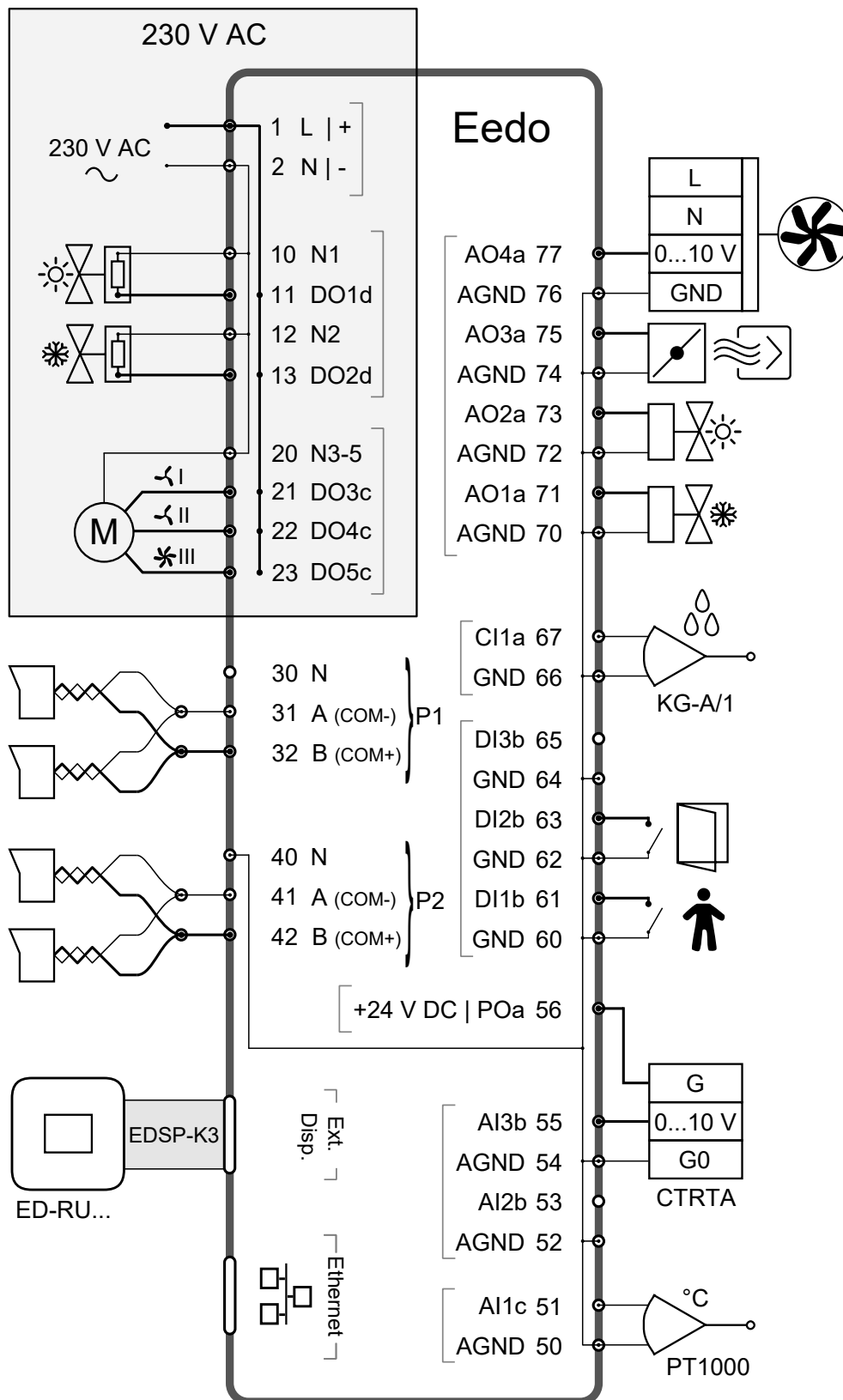

Figure 6-2 Wiring diagram exemplifying controller connections usage.

The ED-RU... room unit is connected to the controller by using a Regin EDSP-K3 cable, as shown in the following wiring diagram.

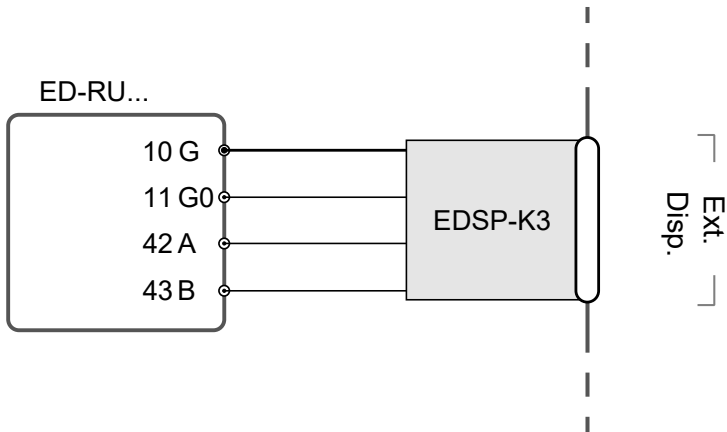

Figure 6-3 Wiring diagram for the ED-RU... room unit.

The following table describes how the EDSP-K3 cable is connected to the room unit.

Table 6-2 ED-RU... room unit terminals and EDSP-K3 wire colors.

Terminal № and designator	EDSP-K3 wire color
10 G	Black
11 G0	White
42 A	Yellow
43 B	Brown

7 LED status indications

An LED is located at the top of the controller cassette and provides information about the controller status and behaviour.

LED colour	Description
Green, solid	Power is on. All is OK.
Red, solid	Battery problem.
Yellow, blinking	The controller is selected from the list in the <i>Search</i> window in Application tool. The <i>Search</i> window is located in the <i>Tools -> Search for controllers</i> menu in Application tool.

8 Mounting

The controller is mounted either on a DIN rail inside a cabinet, or on a wall above a false ceiling. The controller form factor is EURO norm, which makes it fit into a standard EURO norm cabinet.



Warning! Before installation or maintenance, the power supply must first be disconnected in order to prevent potentially lethal electric shocks! Installation or maintenance of this unit should only be carried out by qualified personnel. The manufacturer is not responsible for any eventual damage or injury caused by inadequate skills during installation, or through removal of or deactivation of any safety devices.



Warning! When mounting the controller on a DIN rail, the controller must be placed inside a cabinet to prevent electric shock. When mounting the controller on a wall, the terminal protection covers must be attached to prevent electric shock.

8.1 DIN rail mounting inside a cabinet

To mount the controller:

1. Pull out the fastener.
2. Attach the controller to the rail.
3. Push in the fastener to secure the controller.

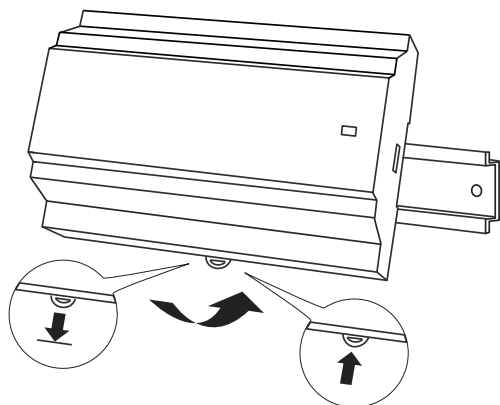

Figure 8-1 Attaching the controller to the DIN rail.

8.2 Wall Mounting

To mount the controller:

1. Attach the baseplate to the wall using screws.

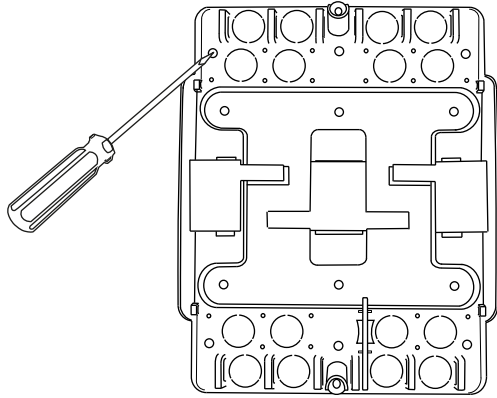

Figure 8-2 Attaching the baseplate to the wall.

2. Pull out the fastener and attach the controller to the baseplate, and then push in the fastener to secure the controller.

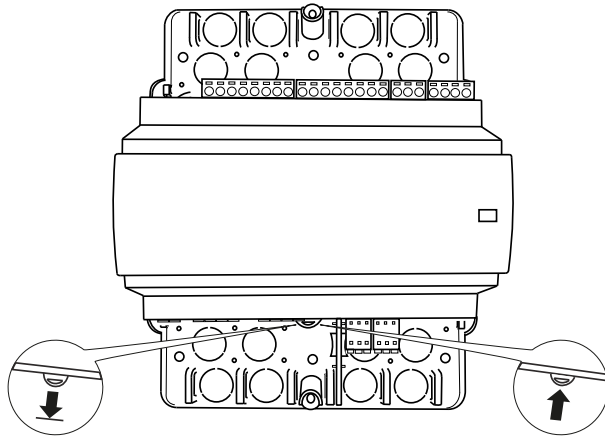

Figure 8-3 Attaching the controller to the baseplate.

3. Check that the pre-mounted partition between the 230 V and 24 V terminals is securely attached.

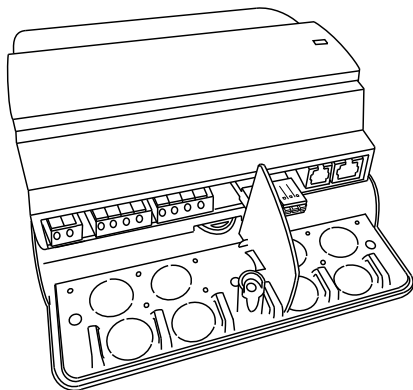

Figure 8-4 The pre-mounted partition on the baseplate.

4. Attach the terminal protection covers to the baseplate, and then secure the covers using the pre-mounted Torx T20 screws.

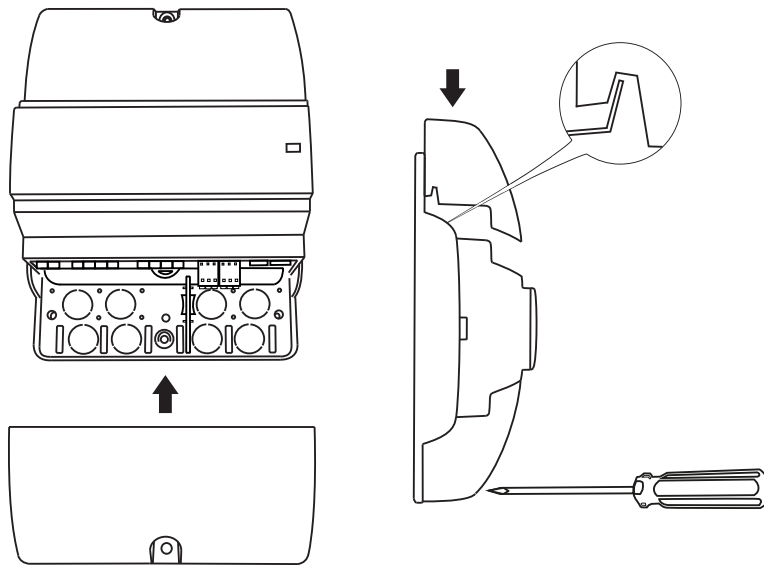

Figure 8-5 Attaching and securing the terminal protection covers.

9 Maintenance and service



Warning! Before installation or maintenance, the power supply must first be disconnected in order to prevent potentially lethal electric shocks! Installation or maintenance of this unit should only be carried out by qualified personnel. The manufacturer is not responsible for any eventual damage or injury caused by inadequate skills during installation, or through removal of or deactivation of any safety devices.

9.1 Changing the battery



Warning! To prevent electric shock, the controller must be disconnected from power before the battery is changed.

To change the battery:

1. Disconnect the controller from power, and then remove the terminal protection covers (if wall mounted).
2. Remove the top of the casing by pressing the two tabs on each side of the casing, and then lift up the top of the casing carefully.

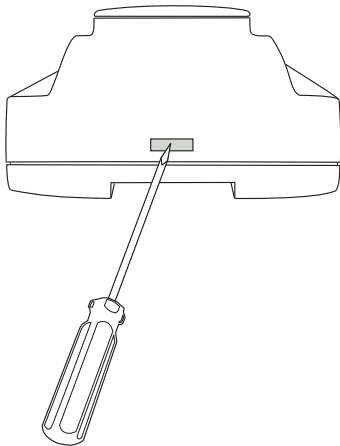

Figure 9-1 Removing the top of the casing.

3. Change the battery. A lithium CR2032 battery is used.
4. Assemble the casing carefully again.
5. Wire the controller, attach the terminal protection covers (if wall mounted), and then power up the controller.

9.2 Changing the fuse



Warning! To prevent electric shock, the controller must be disconnected from power before the fuse is changed.

To change the fuse:

1. Disconnect the controller from power, and then remove the terminal protection covers (if wall mounted).
2. Remove the top of the casing by pressing the two tabs on each side of the casing, see *Figure 9-1*, and then lift up the top of the casing carefully.
3. Change the fuse. A 6.3 AT 5x20 mm fuse is used.
4. Assemble the casing carefully again.
5. Wire the controller, attach the terminal protection covers (if wall mounted), and then power up the controller.

9.3 Resetting the application memory



Warning! This procedure should only be carried out by qualified personnel, since it requires advanced knowledge. The current application will stop running and the controller will return to its default settings which may damage the system.

The controller is reset by pressing the reset button on the side of the casing by using something thin, such as a paper clip. After a reset, the controller starts up again with factory settings applied.

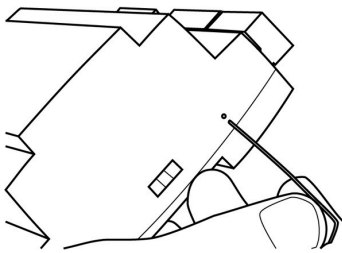

Figure 9-2 Resetting the application memory.

Appendix A Technical data

A.1 General data

Supply voltage	230 V ~ (207...253 V ~ 50/60 Hz)
Power consumption	11 VA
Memory backup	Backup of memory and real-time clock function
Battery type	CR2032 replaceable lithium cell
Battery life	Min. 5 years
Protection class	IP20
Protection class, with terminal protection covers	IP30
Protection class, electrical	Class II
Ambient humidity	Max. 95 % RH (non-condensing)
Ambient temperature	0...55 °C
Storage temperature	-20...+70 °C
Mounting	Wall, DIN rail
Number of DIN modules	8.5
Dimensions, controller unit with terminal blocks (WxHxD)	149 x 121 x 58 mm
Dimensions, controller unit with baseplate and terminal protection covers (WxHxD)	153 x 202 x 68 mm
Cable connections	Pluggable terminal blocks, screw (AI, AO, DI) Pluggable terminal blocks, push-in (COM ports) Fixed terminal blocks, push-in (supply voltage, DO)
Operating system	EXOrealC

Communication ports	RS485	Ethernet	Total
Count	2	1	3

Inputs and outputs	Alb	Alc	Dlb	Cla	AOa	DOc	DOd	POa	Total
Count	2	1	3	1	4	3	2	1	17

A.2 Inputs

Analogue input b (Alb)	0...10 V DC
Analogue input c (Alc)	PT1000
Digital input b (Dlb)	Sourcing input type, GND is reference
Condensation input a (Cla)	Input dedicated for Regin's condensation detector KG-A/1

A.3 Outputs

Analogue output a (AOa)	0...10 V DC, max. 5 mA, short-circuit proof
Digital output c (DOc)	Relay output 230 V AC, max. 3 A
Digital output d (DOd)	Triac output 230 V AC, max. 300 mA

Digital outputs, total max. current (fuse)	6.3 A (6.3 AT 5x20 mm)
Power output a (POa)	24 V DC, max. 50 mA

A.4 RS485 communication port 1

Default protocol	EXOline
Supported protocols	EXOline, Modbus, BACnet MS/TP
Port isolation	Galvanic common mode voltage, max. 150 V
Communication speed	9600 bps (1200...38400 bps)
Parity	Even, Odd, None
Stop bits	1 or 2

A.5 RS485 communication port 2

Default protocol	EXOline
Supported protocols	EXOline, Modbus, BACnet MS/TP
Port isolation	No
Communication speed	9600 bps (1200...38400 bps)
Parity	Even, Odd, None
Stop bits	1 or 2

A.6 Ethernet communication port

Default protocol	EXOline
Supported protocols	EXOline, Modbus IP, BACnet/IP
Communication speed	9600 bps (1200...38400 bps)

Appendix B Room unit display parameter lists

B.1 CTRL

Parameter	Signal name	Default value	Units	Description
1	RCPSettings.RegioControllerMode	9		Control Mode 0=Heating 1=Heating + Heating 2=Heating + Cooling 3=Cooling 4=Heating/Cooling (change-over) 5=Heating + Heating/Cooling (change-over) 6=Heating + VAV 7=Cooling + VAV 8=VAV 9=Heating + Cooling + VAV
2	RCPSettings.RegioHeatSetPointOccupied	22	°C	Room Base setpoint heating
3	RCPSettings.RegioCoolSetPointOccupied	24	°C	Room Base setpoint cooling
4	RCPSettings.RegioRoomTempPBand	10		Temperature PID P Band
5	RCPSettings.RegioRoomTempITime	300	sec	Temperature PID I Time
6	RCPSettings.RegioHeatSetPointUnoccupied	15	°C	Setpoint heating in Unoccupied
7	RCPSettings.RegioCoolSetPointUnoccupied	30	°C	Setpoint Cooling in Unoccupied
8	RCPSettings.RegioSetPointDeadBandStandby	3	°C	Deadband in Standby mode
9	RCPSettings.RegioFrostProtectionSetPoint	8	°C	Setpoint frostprotection
10	RCPSettings.RegioSupplyAirTempLimCascadeFactor	3		Cascade Factor for the Cascade PID
11	RCPSettings.RegioSupplyAirTempLimHeatMinLimit	24	°C	Min Setpoint for the Cascade PID in Heat Mode
12	RCPSettings.RegioSupplyAirTempLimHeatMaxLimit	35	°C	Max Setpoint for the Cascade PID in Heat Mode
13	RCPSettings.RegioSupplyAirTempLimCoolMinLimit	12	°C	Min Setpoint for the Cascade PID in Cool Mode
14	RCPSettings.RegioSupplyAirTempLimCoolMaxLimit	24	°C	Max Setpoint for the Cascade PID in Cool Mode
15	RCPSettings.RegioSupplyAirTempLimFrostProtSetPoint	8	°C	Supply Air Temp Frost Protection Temperature
16	RCPSettings.RegioCO2PBand	100		CO2 PID P Band
17	RCPSettings.RegioCO2ITime	100	sec	CO2 PID I Time
18	RCPSettings.RegioCO2SetPoint	600	ppm	Setpoint for CO2 PI Controller in PPM
37	RCPSettings.RegioUnderfloorHeatingSetpoint ¹	0	°C	Room Setpoint for underfloor heating
38	RCPSettings.RegioUnderfloorHeatingPBand ¹	0		Underfloor heating PI Control P Band
39	RCPSettings.RegioUnderfloorHeatingITime ¹	0	sec	Underfloor heating PI Control I Time
40	RCPSettings.RegioUnderfloorHeatingDisable-Cooling ¹	0		Disable underfloor heating when main area is cooling

1. Only available in Regio Eedo version 2.0-1-04 or later

B.2 SYS

Parameter	Signal name	Default value	Units	Description
1	RCPSettings.RegioControllerStateReturn	3		Select return unit state: 0=Off 1=Unoccupied 2=Stand-by 3=Occupied
2	RCPSettings.RegioControllerStateShutDown	1		Select shutdown state : 0=Off 1=Unoccupied 2=Stand-by 3=Occupied
3	RCPSettings.RegioControllerStatePresence	4		Presence operating mode: 3=Occupied 4=ByPass
4	RCPSettings.RegioControllerStateRemote	5		Is used for remote control: 0=Off 1=Unoccupied 2=Stand-by 3=Occupied 5=No remote control
5	RCPSettings.RegioControllerStateBypassTime	120	min	Time for Bypass mode (Min)
6	RCPSettings.RegioChangeOverSelect	2		Select Change Over: 0=heating 1=cooling 2=Auto
7	RCPSettings.RegioChangeOverType	0		Type of Changeover used in Room 1 0-Digital (Thermostat) 1-Analog Temperature in IncomingPipe
8	RCPSettings.RegioChangeOverAIDiffHeat	3	°C	The difference between the temperature in the room and the media temperature for change over to cooling
9	RCPSettings.RegioChangeOverAIDiffCool	4	°C	The difference between the temperature in the room and the media temperature for change over to heating
10	RCPSettings.RegioCO2PresenceDetection	1		Activate presence on CO2
11	RCPSettings.RegioCO2PresenceLimit	800		Activate presence if CO2 is higher
12	RCPSettings.RegioLightControlFunction	0		Select light control function 0=Central controlled 1=Local Time controlled 2=Presence controlled 3=Time or Presence controlled 4=Central controlled or Presence controlled
21	RCPSettings.RegioAutoSummerTime	1		Switch automatically between summer and winter time
22	Qsystem.Sec	-	sec	System Time Seconds
23	Qsystem.Minute	-	min	System Time Minutes
24	Qsystem.Hour	-	hour	System Time Hours
25	Qsystem.WDay	-		System WeekDay
26	Qsystem.Week	-		System Week
27	Qsystem.Date	-		System Date Day
28	Qsystem.Month	-		System Date Month
29	Qsystem.Year	-		System Date Year
30	RCPSettings.RegioEnableCommFailsafe ¹	0		Enables/Disables the communication Failsafe function
31	RCPSettings.RegioFailsafetime ¹	10	min	Communication failure safe time for triggering Failsafe

Room unit display parameter lists

Parameter	Signal name	Default value	Units	Description
32	RCPSettings.RegioFailsafeState ¹	0		State the controller will revert to if communication Failsafe is active 0=Off 1=Unoccupied 2=Stand-by 3=Occupied 4=ByPass 5=Resume Normal Operation
33	RCPSettings.RegioUnderfloorHeatingEnable ¹	0		Underfloor Enable Condition 0=Disabled 1=Main zone state is Unoccupied or higher 2=Main zone state is Standby or higher 3=Main zone state is Occupied or higher 4=Main zone state is Bypass 5=Always on

1. Only available in Regio Eedo version 2.0–1–04 or later

B.3 ACTR

Parameter	Signal name	Default value	Units	Description
1	RCPSettings.RegioVAVOutputMinLimitOff	0	%	Min Limit for VAV Output at off State
2	RCPSettings.RegioVAVOutputMinLimitUno	10	%	Min Limit for VAV Output at Unoccupied State
3	RCPSettings.RegioVAVOutputMinLimitStandby	10	%	Min Limit for VAV Output at Stanby State
4	RCPSettings.RegioVAVOutputMinLimitOcc	20	%	Min Limit for VAV Output at Occupied or Bypass State
5	RCPSettings.RegioVAVOutputMaxLimit	100	%	Max Limit for VAV Output
11	RCPSettings.RegioHeatValve1Type	0		Output Signal for HeatValve1: 0=0-10V 1=2-10V 2=10-2V 3=10-0V 4=Inc/Dec 5=PWM(Thermal) 6=6 Way-vay valve
12	RCPSettings.RegioHeatValve2Type	0		Output Signal for HeatValve2:
13	RCPSettings.RegioCoolValve1Type	0		Output Signal for CoolValve1:
14	RCPSettings.RegioCoolValve2Type	0		Output Signal for CoolValve2:
15	RCPSettings.RegioHeatCoolValveType	0		Output Signal for ChangeOver/6-WayValve
16	RCPSettings.RegioVAVType	0		Output Signal for VAV
17	RCPSettings.RegioECFANType	0		Output Signal for EC fan
25	RCPSettings.RegioCVHeatExerciseDay	8		Day for exercise heating and heat/cool valve: 0=Never 1-7=mon-sun 8=every day
26	RCPSettings.RegioCVCoolExerciseDay	8		Day for exercise cooling valve: 0=Never 1-7=mon-sun 8=every day
27	RCPSettings.RegioCVHeatExerciseHour	15	hour	Hour for exercise heating and heat/cool valve
28	RCPSettings.RegioCVCoolExerciseHour	15	hour	Hour for exercise cooling valve
29	RCPSettings.RegioHeatExerciseTime	120	sec	Time in seconds to Exercise the Heat Valves
30	RCPSettings.RegioCoolExerciseTime	120	sec	Time in seconds to Exercise the Cool Valves

Parameter	Signal name	Default value	Units	Description
37	RCPSettings.RegioVAVOutputMinLimitBypass ¹	0	%	Min Limit for VAV Output at Bypass State
39	RCPSettings.RegioUnderfloorHeatingValveType ¹	0		Underfloor heating valve type 0=0-10V 1=2-10V 2=10-2V 3=10-0V 4=NU 5=PWM(Thermal)

1. Only available in Regio Eedo version 2.0–1–04 or later

B.4 FAN

Parameter	Signal name	Default value	Units	Description
1	RCPSettings.RegioFanControlMode	0		FanControl Mode 0=No control 1=Controlled by Heating 2=Controlled by cooling 3=Controlled by both heat and cooling
2	RCPSettings.RegioFanSpeed1Start	20	%	If higher controller output start fanspeed 1
3	RCPSettings.RegioFanSpeed2Start	60	%	If higher controller output start fanspeed 2
4	RCPSettings.RegioFanSpeed3Start	100	%	If higher controller output start fanspeed 3
5	RCPSettings.RegioFanSpeedHyst	5	%	Hysteresis % for start/stop fan
6	RCPSettings.RegioRUNoOffFanSpeeds	3		Configured number of fanspeeds (1-3)
7	RCPSettings.RegioMinFanSpeed	0		Min Speed for the fan: 0=Stop 1=Speed 1
8	RCPSettings.RegioFanStopTime	120	sec	Time (Sec) for the Fan Stop delay when Fan AfterBlow used
9	RCPSettings.RegioFanAfterBlowMinSpeed	0		Minimum Fan Speed when FanafterBlow Active

B.5 M/AT

Parameter	Signal name	Default value	Units	Description
1	RCPSettings.RegioLightManual	0		Controls the light when central control
2	RCPSettings.RegioSunBlindsControl	0		Remote Control for the Jalousi: 0=Go In 1=Stop 2=Go out
5	RCPSettings.RegioHeat1OutputSelect	2		Manual/Auto of Heat1 0=Off 1=Manual 2=Auto
6	RCPSettings.RegioHeat2OutputSelect	2		Manual/Auto of Heat2
7	RCPSettings.RegioCoolOutputSelect	2		Manual/Auto of Cool1
8	RCPSettings.RegioHeatCoolOutputSelect	2		Manual/Auto of Heat Cool
9	RCPSettings.RegioVAVOutputSelect	2		Manual/Auto of VAV
10	RCPSettings.RegioECFanOutputSelect	2		Manual/Auto of ECFan
17	RCPSettings.RegioHeat1OutputManual	0	%	Manual value Heat 1

Room unit display parameter lists

Parameter	Signal name	Default value	Units	Description
18	RCPSettings.RegioHeat2OutputManual	0	%	Manual value Heat 2
19	RCPSettings.RegioCoolOutputManual	0	%	Manual value Cool
20	RCPSettings.RegioHeatCoolOutputManual	0	%	Manual value Heat Cool
21	RCPSettings.RegioVAVOutputManual	0	%	Manual value VAV
22	RCPSettings.RegioECFanOutputManual	0	%	Manual value ECFan
29	RCPSettings.RegioLightSelect	2		Manual/Auto of Lighting: 0=Off 1=On 2=Auto
30	RCPSettings.RegioSunBlindsInSelect	2		Manual/Auto of BlindIn
31	RCPSettings.RegioSunBlindsOutSelect	2		Manual/Auto of BlindOut
32	RCPSettings.RegioForcedVentSelect	2		Manual/Auto of ForceVentilation
33	RCPSettings.RegioDigOutSelectSumAlarm	2		Manual/Auto of SumAlarm
34	RCPSettings.RegioDigOutSelectSumAlarmA	2		Manual/Auto of SumAlarmA
35	RCPSettings.RegioDigOutSelectSumAlarmB	2		Manual/Auto of SumAlarmB
43	RCPSettings.RegioFanSelect	4		Fan speed Selected Remote/RegioTool: 0=Off 1=Speed1 2=Speed2 3=Speed3 4=Auto
45	RCPSettings.RegioUnderfloorHeatingSelect ¹	0		Manual/Auto of Underfloor heating 0=Off 1=Manual 2=Auto
46	RCPSettings.RegioUnderfloorHeatingManualValue ¹	0	%	Manual Value Underfloor heating

1. Only available in Regio Eedo version 2.0-1-04 or later

B.6 HMI

Parameter	Signal name	Default value	Units	Description
1	RCPSettings.RegioRUSetPointAdjPos	3	°C	Max allowed offset over setpoint
2	RCPSettings.RegioRUSetPointAdjNeg	3	°C	Max allowed offset below setpoint
5	RCPSettings.RegioRUType	9		Room Unit attached to the controller: 0=None 1=ED-RU 2=ED-RU-O 3=ED-RU-F 4=ED-RU-FO 5=ED-RU-DO 6=ED-RU-DFO 7=ED-RU-DOS 8=ED-RU-H 9=ED-RU-DOCS 10=ED-RUD
6	RCPSettings.RegioRUTempUnit	1		Display Unit: 0=None 1=°C 2=°F

Parameter	Signal name	Default value	Units	Description
7	RCPSettings.RegioRUDisplayViewType	0		Select view mode for the display: 0=Display temperature value 1=Heat setpoint 2=Cool setpoint 3=Average cool/heat setpoint 4=Only setpoint offset 5=CO2 Level
8	RCPSettings.RegioRUDisplaySetPointType	0		Select view mode for the display when pressing increase decrease button: 0=Setpoint offset 1=Controlling setpoint 2=Heat setpoint 3=Cool setpoint
9	RCPSettings.RegioRUButtonsUsed	7		Buttons that can be used in the RU
10	RCPSettings.RegioRUConfigMenuDisable	0		Enable entering the configuration menu in the RU unit when pressing the UP and Down Key
11	RCPSettings.RegioRUDisplayBacklightLow	20		Lightning Lo (0-255)
12	RCPSettings.RegioRUDisplayBacklightHigh	100		Lightning Hi (0-255)
13	RCPSettings.RegioRUDisplayContrast	15		Contrast (0-15)
23	RCPSettings.RegioForceDisplayID	-		Forces the Display to identify themselves (show number on display/blink leds), can leave this state by pressing On/Off button
24	RCPSettings.RegioDisplayIDOnPowerUp	-		If enabled will show display identification on power for 60 seconds or press of the on/off button
25	RCPSettings.RegioForceDisplaySearch	-		Trigger a search for display on display port
26	Not used	-		Not used
27	RCPSettings.RegioResetRUSettingsOnShutdown ¹	0		Enables reset of user inputs on shutdown
29	RCPSettings.RegioFanButtonBehaviour ¹	0		Fan Button Behaviour 0=Manual fan control (default setting) 1=Activates forced ventilation

1. Only available in Regio Eedo version 2.0-1-04 or later

B.7 IO

Parameter	Signal name	Default value	Units	Description
1	RCPSettings.RegioAi1	0		Configuration for Analog input 1 0=Disable 1=External room temp 2=ChangeOver temp 3=Outdoor temp 11=Supply air temp 12=Extra zone temp ¹ 200=Ext. Analog Input PT1000 ¹
2	RCPSettings.RegioAi2	0		Configuration for Analog Input 2 0=Disable 4=Condensation 5=CO2 sensor 6=RH sensor 13=External room temp 0-10 V ² 14=Flow sensor ² 201=Ext. Analog Input 0-10 V ¹

Room unit display parameter lists

Parameter	Signal name	Default value	Units	Description
3	RCPSettings.RegioAi3	0		Configuration for Analog Input 3 0=Disable 4=Condensation 5=CO2 sensor 6=RH sensor 13=External room temp 0-10 V ² 14=Flow sensor ² 201=Ext. Analog Input 0-10 V ¹
5	RCPSettings.RegioDi1	3		Configuration for Digital Input 1 0=Disable 1=Open window 2=Not Used 3=Presence detector 4=Changeover
6	RCPSettings.RegioDi2	1		Configuration for Digital Input 2
7	RCPSettings.RegioDi3	0		Configuration for Digital Input 3
11	RCPSettings.RegioCI	1		Configuration for Digital Condensation Input 1: 0=Disable 1=Regin's KG-A/1 sensor
13	RCPSettings.RegioAo1	1		Configuration for Analog Output 1 0=Disable 1=Heat 2=Heat 2 3=Cool 4=Not used 5=Changeover / 6-Way Valve 6=VAV 7=EC fan
14	RCPSettings.RegioAo2	3		Configuration for Analog Output 2
15	RCPSettings.RegioAo3	6		Configuration for Analog Output 3
16	RCPSettings.RegioAo4	0		Configuration for Analog Output 4
17	RCPSettings.RegioDo1	7		Configuration for Digital Output 1 0 =Disabled 4 =Lighting 5 =Blind in 6 =Blind out 7 =Forced ventilation 8 =Heat valve Inc. 9 =Heat valve Dec 10=Heat valve thermal (PWM) 11=Heat valve 2 Inc. 12=Heat valve 2 Dec. 13=Heat valve 2 thermal (PWM) 14=Cool valve Inc. 15=Cool valve Dec. 16=Cool valve thermal (PWM) 17=Not used 18=Not used 19=Not used 20=Change over valve Inc 21=Change over valve Dec 22=Change over thermal (PWM) 23=SumAlarm 24=SumAlarm A 25=SumAlarm B 26=Heating valve extra zone, thermal (PWM) ¹ 27=Extra zone active signal ¹

Parameter	Signal name	Default value	Units	Description
18	RCPSettings.RegioDo2	23	-	Configuration for Digital Output 2 Same as Digital Output 1
19	RCPSettings.RegioDo3	0	-	Configuration for Digital Output 3 0 =Disabled 1=Fan speed 1 2=Fan speed 2 3=Fan speed 3
20	RCPSettings.RegioDo4	0		Configuration for Digital Output 4 Same as Digital Output 3
21	RCPSettings.RegioDo5	0		Configuration for Digital Output 5 Same as Digital Output 3
23	RCPSettings.RegioAi1Comp	0	°C	Analog input 1 compensation
24	RCPSettings.RegioAi2Comp	0	°C	Analog input 2 compensation
25	RCPSettings.RegioAi3Comp	0	°C	Analog input 3 compensation
27	RCPSettings.RegioInternalTempComp	0	°C	Internal temperature sensor compensation
29	RCPSettings.RegioAnalog1Select ¹	2		Manual Selection for Analog Output 1 0=Off 1=Manual 2=Auto
30	RCPSettings.RegioAnalog2Select ¹	2		Manual Selection for Analog Output 2
31	RCPSettings.RegioAnalog3Select ¹	2		Manual Selection for Analog Output 3
32	RCPSettings.RegioAnalog4Select ¹	2		Manual Selection for Analog Output 4
33	RCPSettings.RegioAnalog1ManualValue ¹	0		Analog Manual Value for Analog Output 1
34	RCPSettings.RegioAnalog2ManualValue ¹	0		Analog Manual Value for Analog Output 2
35	RCPSettings.RegioAnalog3ManualValue ¹	0		Analog Manual Value for Analog Output 3
36	RCPSettings.RegioAnalog4ManualValue ¹	0		Analog Manual Value for Analog Output 4
37	RCPSettings.RegioDigital1Select ¹	2		Manual Selection for Digital Output 1 0=Off 1=Manual 2=Auto
38	RCPSettings.RegioDigital2Select ¹	2		Manual Selection for Digital Output 2
39	RCPSettings.RegioDigital3Select ¹	2		Manual Selection for Digital Output 3
40	RCPSettings.RegioDigital4Select ¹	2		Manual Selection for Digital Output 4
41	RCPSettings.RegioDigital5Select ¹	2		Manual Selection for Digital Output 5

1. Only available in Regio Eedo version 2.0-1-04 or later
2. Only available in Regio Eedo version 2.0-1-05 or later

B.8 ALAM

Parameter	Signal name	Default value	Units	Description
1	RCPSettings.RegioAlarmHyst	0.2		Alarm hysteresis
2	RCPSettings.RegioRoomTempHighLimit	40		High room temp
3	RCPSettings.RegioRoomTempLowLimit	15		Low room temp
4	RCPSettings.RegioRoomTempMaxDeviationLimit	20		Max allowed difference between setpoint and room temp before alarm
9	RCPSettings.RegioCondenseLimit	80		High limit for condense alarm
10	RCPSettings.RegioCondenseHyst	2		Condense alarm hysteresis
13	RCPSettings.RegioCO2MaxLimit	1500	ppm	Max CO2 Level for Alarm

Room unit display parameter lists

Parameter	Signal name	Default value	Units	Description
15	AlaData.AlaPt1_DelayValue	0		Delay value for point no. 1 Condensation
17	AlaData.AlaPt3_DelayValue	0		Delay value for point no. 3 SensorAlarm
19	AlaData.AlaPt5_DelayValue	0		Delay value for point no. 5 Presence
20	AlaData.AlaPt6_DelayValue	0		Delay value for point no. 6 OpenWindow
23	AlaData.AlaPt9_DelayValue	0		Delay value for point no. 9 RoomUnitError
29	AlaData.AlaPt15_DelayValue	0		Delay value for point no. 15 RoomTempHigh
30	AlaData.AlaPt16_DelayValue	0		Delay value for point no. 16 RoomTempLow
31	AlaData.AlaPt17_DelayValue	0		Delay value for point no. 17 RoomTempDeviation
32	AlaData.AlaPt18_DelayValue	0		Delay value for point no. 18 RoomControllerInManualMode
39	AlaData.AlaPt25_DelayValue	10		Delay value for point no. 25 CO2 Level High
41	Alarms.AlaAcknow	0		External acknowledge command
42	Alarms.AlaBlock	0		External blocking command
43	Alarms.AlaUnBlock	0		External unblocking command
44	AlaData.AlaPt27_DelayValue ¹	0		Delay value for point no. 27 Communication fail safe
45	AlaData.AlaPt28_DelayValue ¹	0		Delay value for point no. 28 Hardware Manual Operation
46	AlaData.AlaPt29_DelayValue ¹	0		Delay value for point no. 29 External Alarm Digital Input 1
47	AlaData.AlaPt30_DelayValue ¹	0		Delay value for point no. 30 External Alarm Digital Input 2
48	AlaData.AlaPt31_DelayValue ¹	0		Delay value for point no. 31 External Alarm Digital Input 3

1. Only available in Regio Eedo version 2.0–1–04 or later

Appendix C Modbus signal lists

C.1 Coil status registers

Signal name	Modbus address	Default value	Description
RCPSettings.RegioHeatSequenceOrder	1	0	Y1 and Y2 for Heat/Heat: 0=Y1 before Y2 1=Y2 before Y1
RCPSettings.RegioCoolSequenceOrder	2	0	Y2 and Y3 for Heat/Cool/VAV: 0=Y2 before Y3 1=Y3 before Y2
RCPSettings.RegioChangeOverType	3	0	Type of Changeover used in Room 1: 0=Digital (Thermostat) 1=Analog Temperature in IncomingPipe
RCPSettings.RegioForcedVentSequence	4	0	ForcedVentSequence: 0=Forced Ventilation Just 2nd sequence 1=Force Ventilation both sequences
RCPSettings.RegioCO2FirstSequence	5	0	If enabled in modes 7,8 (cool/cool and heat/cool/vav) the CO2 output will override both outputs if the actual output is lower than the CO2 Output by default it only overrides the second sequence
RCPSettings.RegioCO2PresenceDetection	6	1	Activate presence on CO2
RCPSettings.RegioMinFanSpeed	7	0	Min Speed for the fan (0-Stop 1-Speed 1)
RCPSettings.RegioFanTypeSelector	8	0	Type of Fan used , needed for display purposes in the RU. 0=3Speed Fan 1=EC Fan
RCPSettings.RegioLightManual	9	0	Controls the light when central control
RCPSettings.RegioLightingCmdRemote	10	0	Remote Light Control
RCPSettings.RegioSunBlindsInCmd	11	0	Command to take in jalusi
RCPSettings.RegioSunBlindsOutCmd	12	0	Command to take out jalusi
RCPSettings.Regio3PointValveStopSignal	25	0	If enabled it will stop the output digital signal when full open/close. The signal will stop after 1 minute of full open/close time. This option is applied to all 3 point valves in this system.
RCPSettings.RegioPropValveHeat1NCNO	26	0	Output Type (NC/NO) if puls prop control valves
RCPSettings.RegioPropValveHeat2NCNO	27	0	Output Type (NC/NO) if puls prop control valves
RCPSettings.RegioPropValveCool1NCNO	28	0	Output Type (NC/NO) if puls prop control valves
RCPSettings.RegioPropValveCool2NCNO	29	0	Not used
RCPSettings.RegioPropValveHeatCoolINCNO	30	0	Output Type (NC/NO) if puls prop control valves
RCPSettings.RegioPropValveVAVNCNO	31	0	Output Type (NC/NO) if puls prop control valves
RCPSettings.RegioPropValveECFanCNO	32	0	Output Type (NC/NO) if puls prop control valves
RCPSettings.RegioSixWayValveSequenceOrder	40	0	6-Way Valve Sequence Order: 0=Heat 1st Sequence 1=Heat 2nd Sequence
RCPSettings.RegioDi1NC	42	0	Digital input 1 function : 0=Normally open 1=normally closed
RCPSettings.RegioDi2NC	43	0	Digital input 2 function
RCPSettings.RegioDi3NC	44	0	Digital input 3 function
RCPSettings.RegioRUConfigMenuDisable	48	0	Enable entering the configuration menu in the RU unit when pressing the UP and Down Key
RCPSettings.RegioUseRemoteValues	49	1	1= the RU displays the network values from the master controller (Average for all controllers) 0= the RU will display its own room temperature

Modbus signal lists

Signal name	Modbus address	Default value	Description
RCPSettings.RegioDisable2ndSequence	56	0	If enabled when Condensation input is active in modes with 2 sequences the 2nd sequence will also be set to 0%
RCPSettings.RegioTcplpMasterAddrCommit	58	1	-
RCPSettings.RegioModbusIpEnable	59	0	Enables ModBus IP
RCPSettings.RegioBACnetIpEnable	60	1	Enables BACnet IP datalink
RCPSettings.RegioLogActive	61	1	Activate log function for EXOScada
RCPSettings.RegioAutoSummerTime	62	1	Switch automaticly between summer and winter time
RCPSettings.RegioRemoteRoomTempSelect	66	0	Room Temperature Source Selector: 0=Use Controller Input Values 1=use remote values (Exoline/Modbus/Bacnet)
RCPSettings.RegioRemoteAIChangeOverSelect	67	0	ChangeOver Temperature Source Selector: 0=Use Controller Input Values 1=use remote values (Exoline/Modbus/Bacnet)
RCPSettings.RegioRemoteOutdoorTempSelect	68	0	Outdoor Temperature Source Selector: 0=Use Controller Input Values 1=use remote values (Exoline/Modbus/Bacnet)
RCPSettings.RegioRemoteCondenseSelect	69	0	Condensation Source Selector: 0=Use Controller Input Values 1=use remote values (Exoline/Modbus/Bacnet)
RCPSettings.RegioRemoteRoomCO2Select	70	0	CO2 Source Selector: 0=Use Controller Input Values 1=use remote values (Exoline/Modbus/Bacnet)
RCPSettings.RegioRemoteRoomRHSelect	71	0	RH Temperature Source Selector: 0=Use Controller Input Values 1=use remote values (Exoline/Modbus/Bacnet)
RCPSettings.RegioRemoteSupplyAirSelect	72	0	Supply Air Temperature Source Selector: 0=Use Controller Input Values 1=use remote values (Exoline/Modbus/Bacnet)
RCPSettings.RegioRemoteDIOpenWindowSelect	79	0	Open Window Source Selector: 0=Use Controller Input Values 1=use remote values (Exoline/Modbus/Bacnet)
RCPSettings.RegioRemoteDIPresenceSelect	80	0	Presence Source Selector: 0=Use Controller Input Values 1=use remote values (Exoline/Modbus/Bacnet)
RCPSettings.RegioRemoteDIChangeoverSelect	81	0	ChangeOver State Source Selector: 0=Use Controller Input Values 1=use remote values (Exoline/Modbus/Bacnet)
RCPSettings.RegioRemoteDICondenseAlarmSelect	82	0	Condensation State Source Selector: 0=Use Controller Input Values 1=use remote values (Exoline/Modbus/Bacnet)
RCPSettings.RegioRemoteDIOpenWindow	86	0	Communication Open Window State
RCPSettings.RegioRemoteDIPresence	87	0	Communication Presence State
RCPSettings.RegioRemoteDIChangeover	88	0	Communication ChangeOver State
RCPSettings.RegioRemoteDICondenseAlarm	89	0	Communication Condensation State
RCPActual.RegioCommFailsafe ¹	93	0	Communication Failsafe variable, needs to be set to 1 by the Master to indicate communication
RCPSettings.RegioEnableCommFailsafe ¹	94	0	Enables/Disables the communication Failsafe function 0= Disable 1= Enable
RCPSettings.RegioUnderfloorHeatingDisable-Cooling ¹	95	0	If enabled it will disable underfloor heating when main controller is cooling 0= Disable 1= Enable

Signal name	Modbus address	Default value	Description
RCPSettings.RegioRemoteUnderfloorTempSelect ¹	96	0	Underfloor heating temperature source selector 0= Use controller input values 1= Use remote values (Exoline/Modbus/Bacnet)
RCPSettings.RegioPropValveUnderfloorHeatingNCNO ¹	97	0	Output type (NC/NO) if puls prop control valves
RCPSettings.RegioResetRUSettingsOnShutdown ¹	101	0	Enables reset of user inputs on shutdown 0= Disable 1= Enable
RCPSettings.RegioFanButtonBehaviour ¹	103	0	Fan Button Behaviour 0=Manual fan control (default setting) 1=Activates forced ventilation

1. Only available in Regio Eedo version 2.0–1–04 or later

C.2 Input registers

Signal name	Modbus address	Scale	Description
RCPActual.RegioSoftware	1	1	Type of Regio software (0=RPC)
RCPActual.RegioVerMajor	2	1	Major Version
RCPActual.RegioVerMinor	3	1	Minor Version
RCPActual.RegioVerBranch	4	1	Branch Version (0=Beta, 1=Official)
RCPActual.RegioRevision	5	1	Revision
RCPActual.RegioRoomTempExt	6	10	Room temp external sensor
RCPActual.RegioAIChangeOverTemp	7	10	Change over
RCPActual.RegioOutdoorTemp	8	10	Outdoor temp
RCPActual.RegioCondensation	9	1	Condense
RCPActual.RegioRoomCO2	10	1	Room CO2
RCPActual.RegioRoomRH	11	1	Room RH
RCPActual.RegioSupplyAirTemp	12	10	SupplyAir Temperature
RCPActual.RegioAnaOut1	13	1	Analog output 1
RCPActual.RegioAnaOut2	14	1	Analog output 2
RCPActual.RegioAnaOut3	15	1	Analog output 1
RCPActual.RegioAnaOut4	16	1	Analog output 2
RCPActual.RegioHeatSeq1	17	1	Control valve Heating 1
RCPActual.RegioHeatSeq2	18	1	Control valve Heating 2
RCPActual.RegioCoolSeq1	19	1	Control valve Cooling 1
RCPActual.RegioCoolSeq2	20	1	Not used
RCPActual.RegioHeatCoolOutput	21	1	Control valve Heating/Cooling
RCPActual.RegioVAVOutput	22	1	Control VAV damper
RCPActual.RegioECFanOutput	23	1	Control EC Fan
RCPActual.RegioRoomTemp	24	10	Roomtemp internal or external
RCPActual.RegioControlState	25	1	Current unit state: 0=Off 1=Unoccupied 2=Stand-by 3=Occupied 4=ByPass

Signal name	Modbus address	Scale	Description
RCPActual.RegioHeatCoolSymbol	26	1	Current controller state: 0=Off 1=Heating 2=Cooling 3=Heating and Cooling
RCPActual.RegioPIDSetP	27	10	Setpoint Sent to PID
RCPActual.RegioSetPAdjustment	28	10	Setpoint Adjustment
RCPActual.RegioHeatOutput	29	1	Control signal Heating 0-100 %
RCPActual.RegioCoolOutput	30	1	Control signal Cooling 0-100 %
RCPActual.RegioVAVOutputSignal	31	1	Control signal VAV 0-100%
RCPActual.RegioECFanOutputSignal	32	1	Control signal EC fan 0-100%
RCPActual.RegioFanSpeed	33	1	Current 3speed fan speed: 0=Off 1=Speed1 2=Speed2 3=Speed3
RCPActual.RegioECFanSpeedIndex	34	1	Current EC fan speed converted to index, used in RU: 0=Off 1=Speed1 2=Speed2 3=Speed3
RCPActual.RegioFanSpeedSelectCombined	35	1	Fan speed Selected: 0=Off 1=Speed1 2=Speed2 3=Speed3 4=Forced ventilation 5=Auto
RCPActual.RegioByPassRunMin	36	1	Time left in ByPass mode (min)
RCPActual.RegioRoomTempAverage	65	10	Average Roomtemp internal or external
RCPActual.RegioAIChangeOverAverage	66	10	Average Change over Temperature
RCPActual.RegioOutDoorTempAverage	67	10	Average Temperature from all controllers
RCPActual.RegioCondenseAverage	68	1	Condense Average
RCPActual.RegioRoomCO2Average	69	1	Average CO2 from all controllers
RCPActual.RegioRoomRHAverage	70	1	Average Humidity from all controllers
RCPActual.RegioSupplyAirTempAverage	71	10	SupplyAir Temperature from all controllers
RCPActual.RegioSetpointOffsetCombined	72	10	Setpoint OffSet , last changed offset from all controllers
AlaData.AlaPt1_Status ¹	73	1	Status for point no. 1 Presence 0=Not used 1=Normal 2=Blocked 3=Acknowledge 4=Not used 5=Cancelled 6=Not used 7=Alarm
AlaData.AlaPt2_Status ¹	74	1	Status for point no. 2 OpenWindow
AlaData.AlaPt3_Status ¹	75	1	Status for point no. 3 Condensation
AlaData.AlaPt4_Status ¹	76	1	Status for point no. 4 RoomTempHigh
AlaData.AlaPt5_Status ¹	77	1	Status for point no. 5 RoomTempLow
AlaData.AlaPt6_Status ¹	78	1	Status for point no. 6 RoomTempDeviation
AlaData.AlaPt7_Status ¹	79	1	Status for point no. 7 RoomControllerInManualMode
AlaData.AlaPt8_Status ¹	80	1	Status for point no. 8 SensorAlarm
AlaData.AlaPt9_Status ¹	81	1	Status for point no. 9 RoomUnitError

Signal name	Modbus address	Scale	Description
AlaData.AlaPt25_Status ¹	97	1	Status for point no. 25 CO2 Level High
AlaData.AlaPt27_Status ¹	99	1	Status for point no. 27 Communication fail safe
AlaData.AlaPt28_Status ¹	100	1	Status for point no. 28 Hardware Manual Operation
AlaData.AlaPt29_Status ¹	101	1	Status for point no. 29 External Alarm Digital input 1
AlaData.AlaPt30_Status ¹	102	1	Status for point no. 30 External Alarm Digital input 2
AlaData.AlaPt31_Status ¹	103	1	Status for point no. 31 External Alarm Digital input 3
RCPActual.RegioAnaln1Aux ¹	105	10	Analog Input 1 value, when configured as Ext. Analog Input
RCPActual.RegioAnaln2Aux ¹	106	10	Analog Input 2 value, when configured as Ext. Analog Input
RCPActual.RegioAnaln3Aux ¹	107	10	Analog Input 3 value, when configured as Ext. Analog Input
RCPActual.RegioUnderfloorTemp ¹	109	10	Underfloor Temperature
RCPActual.RegioFlow ²	111	10	Air flow value
AlaData.AlaPt33_Status ²	113	1	Status for point no. 33 Battery Failure

1. Only available in Regio Eedo version 2.0-1-04 or later

2. Only available in Regio Eedo version 2.0-1-05 or later

C.3 Holding registers

Signal name	Modbus address	Default value	Scale	Description
RCPSettings.RegioControllerMode	1	9	1	Control Mode 0=Heating 1=Heating + Heating 2=Heating + Cooling 3=Cooling 4=Heating/Cooling (change-over) 5=Heating + Heating/Cooling (change-over) 6=Heating + VAV 7=Cooling + VAV 8=VAV 9=Heating + Cooling + VAV
RCPSettings.RegioHeatSetPointOccupied	2	22	10	Room Base setpoint heating
RCPSettings.RegioCoolSetPointOccupied	3	24	10	Room Base setpoint cooling
RCPSettings.RegioRoomTempPBand	4	10	1	Temperature PID P Band
RCPSettings.RegioRoomTempITime	5	300	1	Temperature PID I Time
RCPSettings.RegioHeatSetPointUnoccupied	6	15	10	Setpoint heating in Unoccupied
RCPSettings.RegioCoolSetPointUnoccupied	7	30	10	Setpoint Cooling in Unoccupied
RCPSettings.RegioSetPointDeadBandStandby	8	3	10	Deadband in Standby mode
RCPSettings.RegioFrostProtectionSetPoint	9	8	10	Setpoint frostprotection
RCPSettings.RegioRUSetPointAdjPos	10	3	1	Max allowed offset over setpoint
RCPSettings.RegioRUSetPointAdjNeg	11	3	1	Max allowed offset below setpoint
RCPSettings.RegioSetPOffset	12	0	10	not used
RCPSettings.RegioSetPOffsetRemote	13	0	10	Setpoint offset remote ¹
RCPSettings.RegioControllerStateReturn	14	3	1	Select return unit state: 0=Off 1=Unoccupied 2=Stand-by 3=Occupied

Signal name	Modbus address	Default value	Scale	Description
RCPSettings.RegioControllerStateShutDown	15	1	1	Select shutdown state : 0=Off 1=Unoccupied 2=Stand-by 3=Occupied
RCPSettings.RegioControllerStatePresence	16	4	1	Presence operating mode: 3=Occupied 4=ByPass
RCPSettings.RegioControllerStateRemote	17	5	1	Is used for remote control: 0=Off 1=Unoccupied 2=Stand-by 3=Occupied 5=No remote control
RCPSettings.RegioControllerStateBypassTime	18	120	1	Time for Bypass mode (Min)
RCPSettings.RegioPresenceOffDelay	19	10	1	Off timer for changing to not presence (min)
RCPSettings.RegioPresenceOnDelay	20	0	1	On timer for changing to presence (min)
RCPSettings.RegioHeatOutputMinLimit	21	0	1	Min Limit for Heat Output
RCPSettings.RegioHeatOutputMaxLimit	22	100	1	Max Limit for Heat Output
RCPSettings.RegioHeat2OutputMinLimit	23	0	1	Min Limit for Heat Output
RCPSettings.RegioHeat2OutputMaxLimit	24	100	1	Max Limit for Heat Output
RCPSettings.RegioCool1OutputMinLimit	25	0	1	Min Limit for Cool Output
RCPSettings.RegioCool1OutputMaxLimit	26	100	1	Max Limit for Cool Output
RCPSettings.RegioCool2OutputMinLimit	27	0	1	Not used
RCPSettings.RegioCool2OutputMaxLimit	28	100	1	Not used
RCPSettings.RegioVAVOutputMinLimitOff	29	0	1	Min Limit for VAV Output at off State
RCPSettings.RegioVAVOutputMinLimitUno	30	10	1	Min Limit for VAV Output at Unoccupied State
RCPSettings.RegioVAVOutputMinLimitStandby	31	10	1	Min Limit for VAV Output at Stanby State
RCPSettings.RegioVAVOutputMinLimitOcc	32	20	1	Min Limit for VAV Output at Occupied or Bypass State
RCPSettings.RegioVAVOutputMaxLimit	33	100	1	Max Limit for VAV Output
RCPSettings.RegioChangeOverSelect	34	2	1	Select Change Over: 0=heating 1=cooling 2=Auto
RCPSettings.RegioChangeOverAIDiffHeat	35	3	1	The difference between the temperature in the room and the media temperature for change over to cooling
RCPSettings.RegioChangeOverAIDiffCool	36	4	1	The difference between the temperature in the room and the media temperature for change over to heating
RCPSettings.RegioChangeOverValveTime	37	600	1	The minimum time the valve is opend during change over calculation
RCPSettings.RegioMaxAirFlowHeatDemand	38	0	1	Max Airflow on Heat Demand , if above 0% the max ariflow function is enabled
RCPSettings.RegioForcedVentControlMode	39	3	1	Forced Ventilation Control Mode: 0=Off 1=Force Vent on Heat 2=Force Vent on Cool 3=Force Vent on Both Heat and Cool
RCPSettings.RegioForcedVentAtMaxOutput	40	0	1	Forced Ventilation on Max Heat/Cool/Both 0=Off 1=Forced Ventilation on Max Heat 2=Forced Ventilation on Max Cool 3=Forced Ventilation on Max Heat or Cool

Signal name	Modbus address	Default value	Scale	Description
RCPSettings.RegioSupplyAirTempLimCascadeFactor	41	3	1	Cascade Factor for the Cascade PID
RCPSettings.RegioSupplyAirTempLimHeatMinLimit	42	24	1	Min Setpoint for the Cascade PID in Heat Mode
RCPSettings.RegioSupplyAirTempLimHeatMaxLimit	43	35	1	Max Setpoint for the Cascade PID in Heat Mode
RCPSettings.RegioSupplyAirTempLimCoolMinLimit	44	12	1	Min Setpoint for the Cascade PID in Cool Mode
RCPSettings.RegioSupplyAirTempLimCoolMaxLimit	45	24	1	Max Setpoint for the Cascade PID in Cool Mode
RCPSettings.RegioSupplyAirTempLimFrostProtSetPoint	46	8	1	Supply Air Temp Frost Protection Temperature
RCPSettings.RegioCO2PBand	47	100	1	CO2 PID P Band
RCPSettings.RegioCO2ITime	48	100	1	CO2 PID I Time
RCPSettings.RegioCO2SetPoint	49	600	1	Setpoint for CO2 PI Controller in PPM
RCPSettings.RegioCO2PresenceLimit	50	800	1	Activate presence if CO2 is higher
RCPSettings.RegioCO2PresenceHyst	51	160	1	Diff for deactivate presence on CO2
RCPSettings.RegioFanControlMode	52	0	1	FanControl Mode 0=No control 1=Controlled by Heating 2=Controlled by cooling 3=Controlled by both heat and cooling
RCPSettings.RegioFanSpeed1Start	53	20	1	If higher controller output start fanspeed 1
RCPSettings.RegioFanSpeed2Start	54	60	1	If higher controller output start fanspeed 2
RCPSettings.RegioFanSpeed3Start	55	100	1	If higher controller output start fanspeed 3
RCPSettings.RegioFanSpeedHyst	56	5	1	Hysteresis % for start/stop fan
RCPSettings.RegioRUNoOfFanSpeeds	57	3	1	Configured number of fanspeeds (1-3)
RCPSettings.RegioFanSwitchTime	58	2	1	Time (sec) before switching fan speed when changed from RU
RCPSettings.RegioECFanMaxLimit	59	100	1	Max limit for the EC fan (0-100)
RCPSettings.RegioECFanMinLimit	60	10	1	Min limit for the EC fan (0-100)
RCPSettings.RegioECFanStartSpeed	61	15	1	The fan will start at this speed when demand is over the fan speed demand.
RCPSettings.RegioFanStopTime	62	120	1	Time (Sec) for the Fan Stop delay when Fan After-Blow used
RCPSettings.RegioFanAfterBlowControl	63	0	1	If enabled the Fan will work FanStopTime after Heat applied 0=Off 1=Heat1 2=Heat2 3=Heat1 or Heat2
RCPSettings.RegioFanAfterBlowMinSpeed	64	0	1	Minimum Fan Speed when FanafterBlow Active
RCPSettings.RegioKickStartTime	65	0	1	Time (Sec) to Kick Start the Fan, during this time the fan will work at 100%. If 0 this function is not active
RCPSettings.RegioBoostMode	66	2	1	Boost Function will work when on Heating (0) Cooling (1) Both (2)
RCPSettings.RegioConfigFanBoostTime	67	0	1	Time (sec) [0 to 600 seconds] that the Boost Function is active. If 0 the boost function is disabled
RCPSettings.RegioShortStart	68	10	1	Time (sec) that the Fan runs in Max Speed
RCPSettings.RegioBoostPBand	69	5	1	P-band of the P-Controller of the Fan (just in Boost Startup Mode)

Signal name	Modbus address	Default value	Scale	Description
RCPSettings.RegioLightControlFunction	70	0	1	Select light control function 0=Central controlled 1=Local Time controlled 2=Presence controlled 3=Time or Presence controlled 4=Central controlled or Presence controlled
RCPSettings.RegioSunBlindsRunTime	71	240	1	Run time for controlling the jalusi in/out (sec)
RCPSettings.RegioSunBlindsControl	72	0	1	Remote Control for the Jalusi: 0=Go In 1=Stop 2=Go out
RCPSettings.RegioVAVControlType	109	2	1	Control the VAV output: 0=By temperature 2=By CO2 level 3=By both, the highest need
RCPSettings.RegioAi1	143	0	1	Configuration for Analog Input 1 0=Disable 1=External room temp 2=ChangeOver temp 3=Outdoor temp 11=Supply air temp 12=Extra zone temp ² 200=Ext. Analog Input PT1000 ²
RCPSettings.RegioAi2	144	0	1	Configuration for Analog Input 2 0=Disable 4=Condensation 5=CO2 sensor 6=RH sensor 13=External room temp 0-10 V ³ 14=Flow sensor ³ 201=Ext. Analog Input 0...10 V ²
RCPSettings.RegioAi3	145	0	1	Configuration for Analog Input 3 0=Disable 4=Condensation 5=CO2 sensor 6=RH sensor 13=External room temp 0-10 V ³ 14=Flow sensor ³ 201=Ext. Analog Input 0...10 V ²
RCPSettings.RegioDi1	147	3	1	Configuration for Digital Input 1 0=Disable 1=Open window 2=Not Used 3=Presence detector 4=Changeover
RCPSettings.RegioDi2	148	1	1	Configuration for Digital Input 2
RCPSettings.RegioDi3	149	0	1	Configuration for Digital Input 3
RCPSettings.RegioCi1	153	1	1	Configuration for Digital Condensation Input 1: 0=Disable 1=Regin's KG-A/1 sensor
RCPSettings.RegioAo1	155	1	1	Configuration for Analog Output 1 0=Disable 1=Heat 2=Heat 2 3=Cool 4=Not used 5=Changeover / 6-Way Valve 6=VAV 7=EC fan
RCPSettings.RegioAo2	156	3	1	Configuration for Analog Output 2

Signal name	Modbus address	Default value	Scale	Description
RCPSettings.RegioAo3	157	6	1	Configuration for Analog Output 3
RCPSettings.RegioAo4	158	0	1	Configuration for Analog Output 4
RCPSettings.RegioDo1	159	7	1	Configuration for Digital Output 1 0 =Disabled 4 =Lighting 5 =Blind in 6 =Blind out 7 =Forced ventilation 8 =Heat valve Inc. 9 =Heat valve Dec 10=Heat valve thermal (PWM) 11=Heat valve 2 Inc. 12=Heat valve 2 Dec. 13=Heat valve 2 thermal (PWM) 14=Cool valve Inc. 15=Cool valve Dec. 16=Cool valve thermal (PWM) 17=Not used 18=Not used 19=Not used 20=Change over valve Inc 21=Change over valve Dec 22=Change over thermal (PWM) 23=SumAlarm 24=SumAlarm A 25=SumAlarm B 26=Heating valve extra zone, thermal (PWM) ² 27= Extra zone active signal ²
RCPSettings.RegioDo2	160	23	1	Configuration for Digital Output 2 Same as Digital Output 1
RCPSettings.RegioDo3	161	0	1	Configuration for Digital Output 3 0 =Disabled 1 =Fan speed 1 2 =Fan speed 2 3 =Fan speed 3
RCPSettings.RegioDo4	162	0	1	Configuration for Digital Output 4 Same as Digital Output 3
RCPSettings.RegioDo5	163	0	1	Configuration for Digital Output 5 Same as Digital Output 3
RCPSettings.RegioHeatValve1Type	165	0	1	Output Signal for HeatValve1: 0=0-10V 1=2-10V 2=10-2V 3=10-0V 4=Inc/Dec 5=PWM(Thermal) 6=6 Way-vay valve
RCPSettings.RegioHeatValve2Type	166	0	1	Output Signal for HeatValve2:
RCPSettings.RegioCoolValve1Type	167	0	1	Output Signal for CoolValve1:
RCPSettings.RegioCoolValve2Type	168	0	1	Output Signal for CoolValve2:
RCPSettings.RegioHeatCoolValveType	169	0	1	Output Signal for ChangeOver/6-WayValve
RCPSettings.RegioVAVType	170	0	1	Output Signal for VAV
RCPSettings.RegioECFANType	171	0	1	Output Signal for EC fan
RCPSettings.RegioValveHeat1RunTime	179	120	1	Run time (sec) closed to opened valve Heat 1
RCPSettings.RegioValveHeat2RunTime	180	120	1	Run time (sec) closed to opened valve Heat 2
RCPSettings.RegioValveCool1RunTime	181	120	1	Run time (sec) closed to opened valve Cool 1
RCPSettings.RegioValveCool2RunTime	182	120	1	Not used
RCPSettings.RegioValveHeatCoolRunTime	183	120	1	Run time (sec) closed to opened valve HeatCool

Modbus signal lists

Signal name	Modbus address	Default value	Scale	Description
RCPSettings.RegioValveVAVRunTime	184	120	1	Run time (sec) closed to opened valve VAV
RCPSettings.RegioValveECFanRunTime	185	120	1	Run time (sec) closed to opened valve ECFan
RCPSettings.RegioCVDeadbandHeat1	193	2	1	DeadBand increase/decrease (%)
RCPSettings.RegioCVDeadbandHeat2	194	2	1	DeadBand increase/decrease (%)
RCPSettings.RegioCVDeadbandCool1	195	2	1	DeadBand increase/decrease (%)
RCPSettings.RegioCVDeadbandCool2	196	2	1	Not used
RCPSettings.RegioCVDeadbandHeatCool	197	2	1	DeadBand increase/decrease (%)
RCPSettings.RegioCVDeadbandVAV	198	2	1	DeadBand increase/decrease (%)
RCPSettings.RegioCVDeadbandECFan	199	2	1	DeadBand increase/decrease (%)
RCPSettings.RegioPropValveHeat1PeriodTime	207	210	1	Period time (sec) if puls prop control valves
RCPSettings.RegioPropValveHeat2PeriodTime	208	210	1	Period time (sec) if puls prop control valves
RCPSettings.RegioPropValveCool1PeriodTime	209	210	1	Period time (sec) if puls prop control valves
RCPSettings.RegioPropValveCool2PeriodTime	210	210	1	Not used
RCPSettings.RegioPropValveHeatCoolPeriodTime	211	210	1	Period time (sec) if puls prop control valves
RCPSettings.RegioPropValveVAVPeriodTime	212	210	1	Period time (sec) if puls prop control valves
RCPSettings.RegioPropValveECFanPeriodTime	213	210	1	Period time (sec) if puls prop control valves
RCPSettings.RegioCVHeatExerciseDay	221	8	1	Day for exercise heating and heat/cool valve: 0=Never 1-7=mon-sun 8=every day
RCPSettings.RegioCVCoolExerciseDay	222	8	1	Day for exercise cooling valve: 0=Never 1-7=mon-sun 8=every day
RCPSettings.RegioCVHeatExerciseHour	223	15	1	Hour for exercise heating and heat/cool valve
RCPSettings.RegioCVCoolExerciseHour	224	15	1	Hour for exercise cooling valve
RCPSettings.RegioCVHeatExerciseMin	225	0	1	Minute for exercise heating valve
RCPSettings.RegioCVCoolExerciseMin	226	0	1	Minute for exercise cooling valve
RCPSettings.RegioHeatExerciseTime	227	120	1	Time in seconds to Exercise the Heat Valves
RCPSettings.RegioCoolExerciseTime	228	120	1	Time in seconds to Exercise the Cool Valves
RCPSettings.RegioSixWayValveFirstSeqFullyOpen	229	0	10	6 Way valve tension (V) for fully open on 1st sequence
RCPSettings.RegioSixWayValveFirstSeqStartOpen	230	3.3	10	6 Way valve tension (V) for start open on 1st sequence
RCPSettings.RegioSixWayValveSecondSeqStartOpen	231	6.7	10	6 Way valve tension (V) for start open on 2nd sequence
RCPSettings.RegioSixWayValveSecondSeqFullyOpen	232	10	10	6 Way valve tension (V) for fully open on 2nd sequence
RCPSettings.RegioSixWayValveCenterPoint	233	5	10	6 Way valve tension (V) for center point
RCPSettings.RegioSixWayValveCenterPointHyst	234	2	1	6 Way valve centerpoint hysteresis (%)
RCPSettings.RegioAi1Comp	249	0	10	Analog input 1 compensation
RCPSettings.RegioAi2Comp	250	0	10	Analog input 2 compensation
RCPSettings.RegioAi3Comp	251	0	10	Analog input 3 compensation
RCPSettings.RegioCond_0V	253	0	1	Condense at 0 Volt input
RCPSettings.RegioCond_10V	254	100	1	Condense at 10 Volt input
RCPSettings.RegioCO2_0V	255	0	1	CO2 at 0 Volt input
RCPSettings.RegioCO2_10V	256	2000	1	CO2 at 10 Volt input

Signal name	Modbus address	Default value	Scale	Description
RCPSettings.RegioRH_0V	257	0	1	RH at 0 Volt input
RCPSettings.RegioRH_10V	258	100	1	RH at 10 Volt input
RCPSettings.RegioTempFilterFactor	259	0.2	100	Filter factor for temperature on analog input: 0=no filter 1=Max filter
RCPSettings.RegioCondFilterFactor	260	0.2	100	Filter factor for condense on analog input: 0=no filter 1=Max filter
RCPSettings.RegioCO2FilterFactor	261	0.2	100	Filter factor for CO2 on analog input: 0=no filter 1=Max filter
RCPSettings.RegioRHFilterFactor	262	0.2	100	Filter factor for RH on analog input: 0=no filter 1=Max filter
RCPSettings.RegioInternalTempComp	263	0	10	Internal temperature sensor compensation
RCPSettings.RegioHeat1OutputSelect	275	2	1	Manual/Auto of Heat1 0=Off 1=Manual 2=Auto
RCPSettings.RegioHeat2OutputSelect	276	2	10	Manual/Auto of Heat2
RCPSettings.RegioCoolOutputSelect	277	2	1	Manual/Auto of Cool1
RCPSettings.RegioHeatCoolOutputSelect	278	2	1	Manual/Auto of Heat Cool
RCPSettings.RegioVAVOutputSelect	279	2	1	Manual/Auto of VAV
RCPSettings.RegioECFanOutputSelect	280	2	1	Manual/Auto of ECFan
RCPSettings.RegioHeat1OutputManual	287	0	1	Manual value Heat 1
RCPSettings.RegioHeat2OutputManual	288	0	1	Manual value Heat 2
RCPSettings.RegioCoolOutputManual	289	0	1	Manual value Cool
RCPSettings.RegioHeatCoolOutputManual	290	0	1	Manual value Heat Cool
RCPSettings.RegioVAVOutputManual	291	0	1	Manual value VAV
RCPSettings.RegioECFanOutputManual	292	0	1	Manual value ECFan
RCPSettings.RegioLightSelect	299	2	1	Manual/Auto of Lighting: 0=Off 1=On 2=Auto
RCPSettings.RegioSunBlindsInSelect	300	2	1	Manual/Auto of BlindIn 0=Off 1=On 2=Auto
RCPSettings.RegioSunBlindsOutSelect	301	2	1	Manual/Auto of BlindOut 0=Off 1=On 2=Auto
RCPSettings.RegioForcedVentSelect	302	2	1	Manual/Auto of ForceVentilation 0=Off 1=On 2=Auto
RCPSettings.RegioDigOutSelectSumAlarm	303	2	1	Manual/Auto of SumAlarm 0=Off 1=On 2=Auto
RCPSettings.RegioDigOutSelectSumAlarmA	304	2	1	Manual/Auto of SumAlarmA 0=Off 1=On 2=Auto

Modbus signal lists

Signal name	Modbus address	Default value	Scale	Description
RCPSettings.RegioDigOutSelectSumAlarmB	305	2	1	Manual/Auto of SumAlarmB 0=Off 1=On 2=Auto
RCPSettings.RegioFanSelect	313	4	1	Fan speed Selected Remote/RegioTool: 0=Off 1=Speed1 2=Speed2 3=Speed3 4=Auto
RCPSettings.RegioRUType	315	9	1	Room Unit attached to the controller: 0=None 1=ED-RU 2=ED-RU-O 3=ED-RU-F 4=ED-RU-FO 5=ED-RU-DO 6=ED-RU-DFO 7=ED-RU-DOS 8=ED-RU-H 9=ED-RU-DOCS 10=ED-RUD
RCPSettings.RegioRUUserELASelection	316	0	1	User ELA Selection for Room Unit: 0=Auto Detect
RCPSettings.RegioRUTempUnit	317	1	1	Display Unit: 0=None 1=°C 2=°F
RCPSettings.RegioRUTemperatureComp	318	0	1	Temperature Compensation for RU 1
RCPSettings.RegioRUDisplayViewType	319	0	1	Select view mode for the display: 0=Display temperature value 1=Heat setpoint 2=Cool setpoint 3=Average cool/heat setpoint 4=Only setpoint offset 5=CO2 Level
RCPSettings.RegioRUDisplaySetPointType	320	0	1	Select view mode for the display when pressing increase decrease button: 0=Setpoint offset 1=Controlling setpoint 2=Heat setpoint 3=Cool setpoint
RCPSettings.RegioRUSetPointAdjTimeOut	321	5	1	Timeout for setpoint adjustment (sec)
RCPSettings.RegioRUMenuTimeOut	322	10	1	Timeout for menu (sec)
RCPSettings.RegioRUOnOffButtonLongPressTime	323	5	1	Time (sec) that On/Off button must be pushed before Shutdown state
RCPSettings.RegioRUNoOfSelectMenus	324	8	1	Number of menus visible in the RU-DOS
RCPSettings.RegioRUNoOfDecimals	325	1	1	Number of decimal to be showed
RCPSettings.RegioRUDisplayBacklightTime	326	30	1	Time for backlight (sec)
RCPSettings.RegioRUButtonsUsed	327	7	1	Buttons that can be used in the RU
RCPSettings.RegioRUDisplayBacklightLow	328	20	1	Lightning Lo (0-255)
RCPSettings.RegioRUDisplayBacklightHigh	329	100	1	Lightning Hi (0-255)
RCPSettings.RegioRUDisplayContrast	330	15	1	Contrast (0-15)
RCPSettings.RegioAlarmHyst	349	0.2	10	Alarm hysteresis
RCPSettings.RegioRoomTempHighLimit	350	40	1	High room temp
RCPSettings.RegioRoomTempLowLimit	351	15	1	Low room temp
RCPSettings.RegioRoomTempMaxDeviationLimit	352	20	1	Max allowed difference between setpoint and room temp before alarm

Signal name	Modbus address	Default value	Scale	Description
RCPSettings.RegioCondenseLimit	357	80	1	High limit for condense alarm
RCPSettings.RegioCondenseHyst	358	2	1	Condense alarm hysteresis
RCPSettings.RegioCO2MaxLimit	361	1500	1	Max CO2 Level for Alarm
RCPSettings.RegioBaud_Port_1	364	0	1	Bit rate Port 1
RCPSettings.RegioPort1Parity	365	1	1	Port 1 Parity 0=No Parity 1=Odd 2=Even
RCPSettings.RegioTimeOut_Port_1	366	0	1	Port 1 TimeOut
RCPSettings.RegioCharTimeOut_Port_1	367	0	1	Port 1 Char Time Out
RCPSettings.RegioBaud_Port_2	369	0	1	Bit rate Port 2
RCPSettings.RegioPort2Parity	370	1	1	Port 1 Parity 0=No Parity 1=Odd 2=Even
RCPSettings.RegioTimeOut_Port_2	371	0	1	Port 2 TimeOut
RCPSettings.RegioCharTimeOut_Port_2	372	0	1	Port 2 Char Time Out
RCPSettings.RegioMasterPort	373	0	1	-
RCPSettings.RegioRouterDefaultRoute	374	2	1	-
RCPSettings.RegioMin_PLA	375	0	1	-
RCPSettings.RegioMax_PLA	376	255	1	-
RCPSettings.RegioMin_ELA	377	0	1	-
RCPSettings.RegioMax_ELA	378	255	1	-
RCPSettings.RegioTCPIPMasterAnswerTimeout	379	25	1	-
RCPSettings.RegioAlarmActive	381	3	1	Activate alarm and events function for EXOScada 0=Not active 1=Only alarm 2=Only events 3=Alarm and events is active
RCPSettings.RegioRemoteRoomTemp	396	0	10	Communication Room Temperature Value
RCPSettings.RegioRemoteAIChangeOver	397	0	10	Communication Changeover Temperature Value
RCPSettings.RegioRemoteOutdoorTemp	398	0	10	Communication Outdoor Temperature Value
RCPSettings.RegioRemoteCondense	399	0	1	Communication Condensation Value
RCPSettings.RegioRemoteRoomCO2	400	0	1	Communication CO2 Value
RCPSettings.RegioRemoteRoomRH	401	0	1	Communication RH Value
RCPSettings.RegioRemoteSupplyAir	402	0	10	Communication Supply Air Temperature Value
Qsystem.Sec	409	-	1	System Time Seconds
Qsystem.Minute	410	-	1	System Time Minutes
Qsystem.Hour	411	-	1	System Time Hours
Qsystem.WDay	412	-	1	System WeekDay
Qsystem.Week	413	-	1	System Week
Qsystem.Date	414	-	1	System Date Day
Qsystem.Month	415	-	1	System Date Month
Qsystem.Year	416	-	1	System Date Year
Qsystem.PLA	417	254	1	Controller PLA Address
Qsystem.ELA	418	30	1	Controller ELA Adress
AlaPt1_DelayValue ²	419	0	1	Delay value for point no. 1 Presence
AlaPt2_DelayValue ²	420	0	1	Delay value for point no. 2 OpenWindow

Signal name	Modbus address	Default value	Scale	Description
AlaPt3_DelayValue ²	421	0	1	Delay value for point no. 3 Condensation
AlaPt4_DelayValue ²	422	0	1	Delay value for point no. 4 RoomTempHigh
AlaPt5_DelayValue ²	423	0	1	Delay value for point no. 5 RoomTempLow
AlaPt6_DelayValue ²	424	0	1	Delay value for point no. 6 RoomTempDeviation
AlaPt7_DelayValue ²	425	0	1	Delay value for point no. 7 RoomControllerInManualMode
AlaPt8_DelayValue ²	426	0	1	Delay value for point no. 8 SensorAlarm
AlaPt9_DelayValue ²	427	0	1	Delay value for point no. 9 RoomUnitError
AlaPt25_DelayValue ²	443	10	1	Delay value for point no. 25 CO2 Level High
AlaAcknow ²	445	0	1	External acknowledge command
AlaBlock ²	446	0	1	External blocking command
AlaUnBlock ²	447	0	1	External unblocking command
AlaData.AlaPt27_DelayValue ²	448	0	1	Delay value for point no. 27 Communication fail safe
AlaData.AlaPt28_DelayValue ²	449	0	1	Delay value for point no. 28 Hardware Manual Operation
AlaData.AlaPt29_DelayValue ²	450	0	1	Delay value for point no. 29 External Alarm Digital Input 1
AlaData.AlaPt30_DelayValue ²	451	0	1	Delay value for point no. 30 External Alarm Digital Input 2
AlaData.AlaPt31_DelayValue ²	452	0	1	Delay value for point no. 31 External Alarm Digital Input 3
RCPSettings.RegioFailsafetime	454	10	1	Communication failure safe time for triggering Failsafe
RCPSettings.RegioFailsafeState ²	455	0	1	State the controller will revert to if communication Failsafe is active 0=Off 1=Unoccupied 2=Stand-by 3=Occupied 4=ByPass 5=Keep Current
RCPSettings.RegioAnalog1Select ²	456	2	1	Manual Selection for Analog Output 1 0=Off 1=Manual 2=Auto
RCPSettings.RegioAnalog2Select ²	457	2	1	Manual Selection for Analog Output 2
RCPSettings.RegioAnalog3Select ²	458	2	1	Manual Selection for Analog Output 3
RCPSettings.RegioAnalog4Select ²	459	2	1	Manual Selection for Analog Output 4
RCPSettings.RegioAnalog1ManualValue ²	460	0	10	Analog Manual Value for Analog Output 1
RCPSettings.RegioAnalog2ManualValue ²	461	0	10	Analog Manual Value for Analog Output 2
RCPSettings.RegioAnalog3ManualValue ²	462	0	10	Analog Manual Value for Analog Output 3
RCPSettings.RegioAnalog4ManualValue ²	463	0	10	Analog Manual Value for Analog Output 4
RCPSettings.RegioDigital1Select ²	464	2	1	Manual Selection for Digital Output 1 0=Off 1=On 2=Auto
RCPSettings.RegioDigital2Select ²	465	2	1	Manual Selection for Digital Output 2
RCPSettings.RegioDigital3Select ²	466	2	1	Manual Selection for Digital Output 3
RCPSettings.RegioDigital4Select ²	467	2	1	Manual Selection for Digital Output 4

Signal name	Modbus address	Default value	Scale	Description
RCPSettings.RegioDigital5Select ²	468	2	1	Manual Selection for Digital Output 5
RCPSettings.RegioVAVOutputMinLimitBypass ²	469	0	1	Min Limit for VAV Output at Bypass State
RCPSettings.RegioUnderfloorHeatingSetpoint ²	471	0	10	Room Setpoint for underfloor heating
RCPSettings.RegioUnderfloorHeatingEnable ²	472	0	1	Underfloor Enable Condition
RCPSettings.RegioUnderfloorHeatingPBand ²	473	0	1	Underfloor heating PI Control P Band
RCPSettings.RegioUnderfloorHeatingITime ²	474	0	1	Underfloor heating PI Control I Time
RCPSettings.RegioRemoteUnderfloortemp ²	475	0	10	Communication Underfloor Temperature Value
RCPSettings.RegioUnderfloorHeatingSelect ²	476	0	1	Manual/Auto of Underfloor heating 0=Off 1=Manual 2=Auto
RCPSettings.RegioUnderfloorHeatingManual-Value ²	477	0	1	Manual Value Underfloor heating
RCPSettings.RegioUnderfloorHeatingValveType ²	478	0	1	Underfloor heating valve type 0=0-10 V 1=2-10V 2=10-2 V 3=10-0 V 4=NU 5=PWM (Thermal)
RCPSettings.RegioPropValveUnderfloorHeating-PeriodTime ²	479	0	1	Period time (sec) if puls prop control valves
RCPSettings.RegioECFanAtForcedVentilation ²	489	0	1	EC Fan speed at forced ventilation
RCPSettings.RegioRoomtemp_0V ³	491	0	1	Room temperature at 0 Volt input
RCPSettings.RegioRoomtemp_10V ³	492	100	1	Room temperature at 10 Volt input
RCPSettings.RegioFlow_0V ³	493	0	1	Air flow at 0 Volt input
RCPSettings.RegioFlow_10V ³	494	100	1	Air flow at 10 Volt input
RCPSettings.RegioRoomtempFilterFactor ³	495	0.2	100	Filter factor for room temperature on analog input: 0=no filter 1=Max filter
RCPSettings.RegioFlowFilterFactor ³	496	0.2	100	Filter factor for air flow on analog input: 0=no filter 1=Max filter
AlaData.AlaPt33_DelayValue ³	504	0	1	Delay value for point no. 33 Battery Failure

1. Setpoint Offset Remote is a write only register affecting the current setpoint offset when writing. It will also only affect the current setpoint offset when the value is changed. Example: User has set +2 from a room unit, The Offset remote register will read anything previously written to it, for example 0 (not showing +2 as might have been expected), To change the offset to 0 it is necessary to write something different from 0 first and then 0 again. The function of this register will be updated in future versions.

2. Only available in Regio Eedo version 2.0-1-04 or later

3. Only available in Regio Eedo version 2.0-1-05 or later

C.4 Input status registers

Signal name	Modbus address	Description
RCPActual.RegioOpenWindowInd	1	Open window indication
RCPActual.RegioCondensationAlarm	2	Alarm Condensation indication
RCPActual.RegioPresenceInd	3	Pressens indication
RCPActual.RegioChangeOverInd	4	Change over indication
RCPActual.RegioDigOut1	5	Digital output 1
RCPActual.RegioDigOut2	6	Digital output 2
RCPActual.RegioDigOut3	7	Digital output 3
RCPActual.RegioDigOut4	8	Digital output 4

Modbus signal lists

Signal name	Modbus address	Description
RCPActual.RegioDigOut5	9	Digital output 5
RCPActual.RegioDigOut6	10	Digital output 6
RCPActual.RegioFanSpeed1Output	11	Start Fan Speed 1
RCPActual.RegioFanSpeed2Output	12	Start Fan Speed 2
RCPActual.RegioFanSpeed3Output	13	Start Fan Speed 3
RCPActual.RegioLightingOutput	14	Start signal Lighting
RCPActual.RegioSunBlindsInOutput	15	In signal Blind
RCPActual.RegioSunBlindsOutOutput	16	Out signal Blind
RCPActual.RegioForcedVentOutput	17	Start forced ventilation
RCPActual.RegioHeat1IncOutput	18	Increase heat 1 valve
RCPActual.RegioHeat1DecOutput	19	Decrease heat 1 valve
RCPActual.RegioHeat1PulsPropOutput	20	Puls prop heat 1 valve
RCPActual.RegioHeat2IncOutput	21	Increase heat 2 valve
RCPActual.RegioHeat2DecOutput	22	Decrease heat 2 valve
RCPActual.RegioHeat2PulsPropOutput	23	Puls prop heat 2 valve
RCPActual.RegioCool1IncOutput	24	Increase cool 1 valve
RCPActual.RegioCool1DecOutput	25	Decrease cool 1 valve
RCPActual.RegioCool1PulsPropOutput	26	Puls prop cool 1 valve
RCPActual.RegioCool2IncOutput	27	Not used
RCPActual.RegioCool2DecOutput	28	Not used
RCPActual.RegioCool2PulsPropOutput	29	Not used
RCPActual.RegioHeatCoolIncOutput	30	Increase Heat cool valve
RCPActual.RegioHeatCoolDecOutput	31	Decrease Heat cool valve
RCPActual.RegioHeatCoolPulsPropOutput	32	Puls prop Heat cool valve
RCPActual.RegioSumAlarm	33	Sum alarm
RCPActual.RegioSumAlarmA	34	Sum alarm A
RCPActual.RegioSumAlarmB	35	Sum alarm B
RCPActual.RegioRoomTempControlState	36	Current controller state: 0=Heating 1=Cooling
RCPActual.RegioSunBlindsState	37	Blind Position: 0=In 1=Out
RCPActual.RegioPresence	38	Presence indication
RCPActual.RegioCO2Presence	39	Is set if presence if CO2 is high
RCPActual.RegioAIChangeOverState	40	Is set if change over from analog input
RCPActual.RegioChangeOverState	41	Is set if change over
RCPActual.RegioRoomTempSensorAlarm	42	Is set if sensor alarm on room sensor (Internal or external)
RCPActual.RegioTimeGroupOcc	43	Time Group 'Occupied' (No. 1).
RCPActual.RegioTimeGroupUnOcc	44	Time Group 'UnOccupied' (No. 2).
RCPActual.RegioTimeGroupLighting	45	Time Group 'Lighting' (No. 3).
RCPActual.RegioExerciseOnHeat1	85	Valve Heat 1 in exercise
RCPActual.RegioExerciseOnHeat2	86	Valve Heat 2 in exercise
RCPActual.RegioExerciseOnCool1	87	Valve Cool 1 in exercise
RCPActual.RegioExerciseOnCool2	88	Not used

Signal name	Modbus address	Description
RCPActual.RegioExerciseOnHeatCool	89	Valve HeatCool in exercise
RCPActual.RegioDIOpenWindowCombined	95	Open window indication all Controllers
RCPActual.RegioDICondenseAlarmCombined	96	Alarm Condens indication all Controllers
RCPActual.RegioDIPresenceCombined	97	Pressens indication all Controllers (This is the combination of all pins not actualy the presence state)
RCPActual.RegioDIChangeoverCombined	98	Change over indication all Controllers
RCPActual.RegioCommFailsafeActive ¹	99	Indicates communication Failsafe state
RCPActual.RegioDigIn1Aux ¹	100	Digital Input 1 value when configured as Ext. Digital Input
RCPActual.RegioDigIn2Aux ¹	101	Digital Input 2 value when configured as Ext. Digital Input
RCPActual.RegioDigIn3Aux ¹	102	Digital Input 3 value when configured as Ext. Digital Input

1. Only available in Regio Eedo version 2.0–1–04 or later

Appendix D BACnet signal lists

D.1 Multistate values

Signal name	Object name	Instance number	Writeable	Description
RCPSettings. RegioControllerStateRemote	RegioControllerStateRemote	30010	YES	Is used for remote control 1=Off 2=Unoccupied 3=Stand-by 4=Occupied 6=No remote control
RCPSettings. RegioChangeOverSelect	RegioChangeOverSelect	30017	YES	Select Change Over 1=Heating 2=Cooling 3=Auto
RCPSettings. RegioFanAfterBlowMinSpeed	RegioFanAfterBlowMinSpeed	30030	YES	Minimum Fan Speed when FanafterBlow Active 1=Off 2=Speed1 3=Speed2 4=Speed3
RCPSettings. RegioLightControlFunction	RegioLightControlFunction	30031	YES	Select light control function 1=Central controlled 2=Local Time controlled 3=Presence controlled 4=Time or Presence controlled 5=Central controlled or Presence controlled
RCPSettings. RegioSunBlindsControl	RegioSunBlindsControl	30032	YES	Remote Control for the Jalusi 1=Go In 2=Stop 3=Go out
RCPSettings. RegioHeat1OutputSelect	RegioHeat1OutputSelect	30080	YES	Manual/Auto of Heat1 1=Off 2=Manual 3=Auto
RCPSettings. RegioHeat2OutputSelect	RegioHeat2OutputSelect	30081	YES	Manual/Auto of Heat2 1=Off 2=Manual 3=Auto
RCPSettings. RegioCoolOutputSelect	RegioCoolOutputSelect	30082	YES	Manual/Auto of Cool1 1=Off 2=Manual 3=Auto
RCPSettings. RegioHeatCoolOutputSelect	RegioHeatCoolOutputSelect	30083	YES	Manual/Auto of Heat Cool 1=Off 2=Manual 3=Auto
RCPSettings. RegioVAVOutputSelect	RegioVAVOutputSelect	30084	YES	Manual/Auto of VAV 1=Off 2=Manual 3=Auto
RCPSettings. RegioECFanOutputSelect	RegioECFanOutputSelect	30085	YES	Manual/Auto of ECFan 1=Off 2=Manual 3=Auto
RCPSettings.RegioLightSelect	RegioLightSelect	30104	YES	Manual/Auto of Lighting 1=Off 2=On 3=Auto
RCPSettings. RegioSunBlindsInSelect	RegioSunBlindsInSelect	30105	YES	Manual/Auto of BlindIn 1=Off 2=On 3=Auto

Signal name	Object name	Instance number	Writeable	Description
RCPSettings.RegioSunBlindsOutSelect	RegioSunBlindsOutSelect	30106	YES	Manual/Auto of BlindOut 1=Off 2=On 3=Auto
RCPSettings.RegioForcedVentSelect	RegioForcedVentSelect	30107	YES	Manual/Auto of ForceVentilation 1=Off 2=On 3=Auto
RCPSettings.RegioDigOutSelectSumAlarm	RegioDigOutSelectSumAlarm	30108	YES	Manual/Auto of SumAlarm 1=Off 2=On 3=Auto
RCPSettings.RegioDigOutSelectSumAlarmA	RegioDigOutSelectSumAlarmA	30109	YES	Manual/Auto of SumAlarmA 1=Off 2=On 3=Auto
RCPSettings.RegioDigOutSelectSumAlarmB	RegioDigOutSelectSumAlarmB	30110	YES	Manual/Auto of SumAlarmB 1=Off 2=On 3=Auto
RCPSettings.RegioFanSelect	RegioFanSelect	30118	YES	Fan speed Selected Remote/RegioTool 1=Off 2=Speed1 3=Speed2 4=Speed3 5=Auto
RCPSettings.RegioRUTempUnit	RegioRUTempUnit	30120	YES	Display Unit 1=None 2=°C 3=°F
RCPSettings.RegioFailsafeState ¹	RegioFailsafeState	30182	YES	State the controller will revert to if communication Failsafe is active
RCPSettings.RegioAnalog1Select ¹	RegioAnalog1Select	30183	YES	Manual Selection for Analog Output 0=Off 1=Manual 2=Auto
RCPSettings.RegioAnalog2Select ¹	RegioAnalog2Select	30184	YES	Manual Selection for Analog Output 2 0=Off 1=Manual 2=Auto
RCPSettings.RegioAnalog3Select ¹	RegioAnalog3Select	30185	YES	Manual Selection for Analog Output 3 0=Off 1=Manual 2=Auto
RCPSettings.RegioAnalog4Select ¹	RegioAnalog4Select	30186	YES	Manual Selection for Analog Output 4 0=Off 1=Manual 2=Auto
RCPSettings.RegioDigital1Select ¹	RegioDigital1Select	30191	YES	Manual Selection for Digital Output 1 0=Off 1=On 2=Auto
RCPSettings.RegioDigital2Select ¹	RegioDigital2Select	30192	YES	Manual Selection for Digital Output 2 0=Off 1=On 2=Auto
RCPSettings.RegioDigital3Select ¹	RegioDigital3Select	30193	YES	Manual Selection for Digital Output 3 0=Off 1=On 2=Auto

Signal name	Object name	Instance number	Writeable	Description
RCPSettings.RegioDigital4Select ¹	RegioDigital4Select	30194	YES	Manual Selection for Digital Output 4 0=Off 1=On 2=Auto
RCPSettings.RegioDigital5Select ¹	RegioDigital5Select	30195	YES	Manual Selection for Digital Output 5 0=Off 1=On 2=Auto
RCPSettings.RegioUnderfloorHeatingEnable ¹	RegioUnderfloorHeatingEnable	30199	YES	Underfloor Enable Condition 0=Disabled 1=Higher than off 2=Higher than Unocc 3=Higher than Standby 4=Higher than Occ 5=Always on
RCPSettings.RegioUnderfloorHeatingSelect ¹	RegioUnderfloorHeatingSelect	30203	YES	Manual/Auto of Underfloor heating 0=Off 1=Manual 2=Auto
RCPSettings.RegioUnderfloorHeatingValveType ¹	RegioUnderfloorHeatingValveType	30205	YES	Underfloor heating valve type 0=0-10 V 1=2-10 V 2=10-2 V 3=10-0 V 4=NU 5=PWM(Thermal)
RCPSettings.RegioControllerMode	RegioControllerMode	40001	NO	Control Mode 1=Heating 2=Heating + Heating 3=Heating + Cooling 4=Cooling 5=Heating/Cooling (change-over) 6=Heating + Heating/Cooling (change-over) 7=Heating + VAV 8=Cooling + VAV 9=VAV 10=Heating + Cooling + VAV
RCPActual.RegioControlState	RegioControlState	40027	NO	Current unit state 1=Off 2=Unoccupied 3=Stand-by 4=Occupied 5=ByPass
RCPActual.RegioHeatCoolSymbol	RegioHeatCoolSymbol	40028	NO	Current controller state 1=Off 2=Heating 3=Cooling 4=Heating and Cooling
RCPActual.RegioFanSpeed	RegioFanSpeed	40035	NO	Current 3speed fan speed 1=Off 2=Speed1 3=Speed2 4=Speed3
RCPActual.RegioFanSpeedSelectCombined	RegioFanSpeedSelectCombined	40037	NO	Fan speed Selected 1=Off 2=Speed1 3=Speed2 4=Speed3 5=Auto

Signal name	Object name	Instance number	Writeable	Description
AlaData.AlaPt1_Status	AlaPt1_Status	40075	NO	Status for point no. 1 Presence1 0=Not used 1=Normal 2=Blocked 3=Acknowledge 4=Not used 5=Cancelled 6=Not used 7=Alarm
AlaData.AlaPt2_Status	AlaPt2_Status	40076	NO	Status for point no. 2 OpenWindow
AlaData.AlaPt3_Status	AlaPt3_Status	40077	NO	Status for point no. 3 Condensation
AlaData.AlaPt4_Status	AlaPt4_Status	40078	NO	Status for point no. 4 RoomTempHigh
AlaData.AlaPt5_Status	AlaPt5_Status	40079	NO	Status for point no. 5 RoomTempLow
AlaData.AlaPt6_Status	AlaPt6_Status	40080	NO	Status for point no. 6 RoomTempDeviation
AlaData.AlaPt7_Status	AlaPt7_Status	40081	NO	Status for point no. 7 RoomControllerInManualMode
AlaData.AlaPt8_Status	AlaPt8_Status	40082	NO	Status for point no. 8 SensorAlarm
AlaData.AlaPt9_Status	AlaPt9_Status	40083	NO	Status for point no. 9 RoomUnitError
AlaData.AlaPt25_Status	AlaPt25_Status	40099	NO	Status for point no. 25 CO2 Level High
AlaData.AlaPt27_Status ¹	AlaPt27_Status	40101	NO	Status for point no. 27 Communication fail safe
AlaData.AlaPt28_Status ¹	AlaPt28_Status	40102	NO	Status for point no. 28 Hardware Manual Operation
AlaData.AlaPt29_Status ¹	AlaPt29_Status	40103	NO	Status for point no. 29 External Alarm Digital input 1
AlaData.AlaPt30_Status ¹	AlaPt30_Status	40104	NO	Status for point no. 30 External Alarm Digital input 2
AlaData.AlaPt31_Status ¹	AlaPt31_Status	40105	NO	Status for point no. 31 External Alarm Digital input 3
AlaData.AlaPt33_Status ²	AlaPt33_Status	40107	NO	Status for point no. 33 Battery Failure

1. Only available in Regio Eedo version 2.0-1-04 or later

2. Only available in Regio Eedo version 2.0-1-05 or later

D.2 Binary values

Signal name	Object name	Instance number	Writeable	Description
RCPSettings.RegioLightManual	RegioLightManual	10001	YES	Controls the light when central control
RCPSettings.RegioLightingCmdRemote	RegioLightingCmdRemote	10002	YES	Remote Light Control
RCPSettings.RegioRUConfigMenuDisable	RegioRUConfigMenuDisable	10005	YES	Enable entering the configuration menu in the RU unit when pressing the UP and Down Key
RCPSettings.RegioForceDisplayID	RegioForceDisplayID	10007	YES	Forces the Display to identify themselves (show number on display/blink LEDs), can leave this state by pressing On/Off button
RCPSettings.RegioAutoSummerTime	RegioAutoSummerTime	10008	YES	Switch automatically between summer and winter time
RCPActual.RegioCommFailsafe ¹	RegioCommFailsafe	10009	YES	Communication Failsafe variable Master should set it to 1 to reset timer
RCPSettings.RegioEnableCommFailsafe ¹	RegioEnableCommFailsafe	10010	YES	Enables/Disables the communication Failsafe function

Signal name	Object name	Instance number	Writeable	Description
RCPSettings.RegioUnderfloorHeatingDisableCooling ¹	RegioUnderfloorHeatingDisableCooling	10011	YES	Disable underfloor heating when main area is cooling
RCPSettings.RegioRemoteUnderfloorTempSelect ¹	RegioRemoteUnderfloorTempSelect	10012	YES	Underfloor Temperature Source Selector 0-Use Controller Input Values 1-use remote values (Exoline/Modbus/Bacnet)
RCPSettings.RegioPropValveUnderfloorHeatingNCNO ¹	RegioPropValveUnderfloorHeatingNCNO	10013	YES	Output Type (NC/NO) if puls prop control valves
RCPSettings.RegioResetRUSettingsOnShutdown ¹	RegioResetRUSettingsOnShutdown	10017	YES	Enables reset of user inputs on shutdown
RCPSettings.RegioFanButtonBehaviour ¹	RegioFanButtonBehaviour	10019	YES	Fan Button Behaviour 1=Manual fan control (default setting) 2=Activates forced ventilation
RCPActual.RegioOpenWindowInd	RegioOpenWindowInd	20001	NO	Open window indication
RCPActual.RegioCondensationAlarm	RegioCondensationAlarm	20002	NO	Alarm Condensation indication
RCPActual.RegioPresenceInd	RegioPresenceInd	20003	NO	Presens indication
RCPActual.RegioChangeOverInd	RegioChangeOverInd	20004	NO	Change over indication
RCPActual.RegioDigOut1	RegioDigOut1	20005	NO	Digital output 1
RCPActual.RegioDigOut2	RegioDigOut2	20006	NO	Digital output 2
RCPActual.RegioDigOut3	RegioDigOut3	20007	NO	Digital output 3
RCPActual.RegioDigOut4	RegioDigOut4	20008	NO	Digital output 4
RCPActual.RegioFanSpeed1Output	RegioFanSpeed1Output	20011	NO	Start Fan Speed 1
RCPActual.RegioFanSpeed2Output	RegioFanSpeed2Output	20012	NO	Start Fan Speed 2
RCPActual.RegioFanSpeed3Output	RegioFanSpeed3Output	20013	NO	Start Fan Speed 3
RCPActual.RegioLightingOutput	RegioLightingOutput	20014	NO	Start signal Lighting
RCPActual.RegioSunBlindsInOutput	RegioSunBlindsInOutput	20015	NO	In signal Blind
RCPActual.RegioSunBlindsOutOutput	RegioSunBlindsOutOutput	20016	NO	Out signal Blind
RCPActual.RegioForcedVentOutput	RegioForcedVentOutput	20017	NO	Start forced ventilation
RCPActual.RegioHeat1IncOutput	RegioHeat1IncOutput	20018	NO	Increase heat 1 valve
RCPActual.RegioHeat1DecOutput	RegioHeat1DecOutput	20019	NO	Decrease heat 1 valve
RCPActual.RegioHeat1PulsPropOutput	RegioHeat1PulsPropOutput	20020	NO	Puls prop heat 1 valve
RCPActual.RegioHeat2IncOutput	RegioHeat2IncOutput	20021	NO	Increase heat 2 valve
RCPActual.RegioHeat2DecOutput	RegioHeat2DecOutput	20022	NO	Decrease heat 2 valve
RCPActual.RegioHeat2PulsPropOutput	RegioHeat2PulsPropOutput	20023	NO	Puls prop heat 2 valve
RCPActual.RegioCool1IncOutput	RegioCool1IncOutput	20024	NO	Increase cool 1 valve
RCPActual.RegioCool1DecOutput	RegioCool1DecOutput	20025	NO	Decrease cool 1 valve
RCPActual.RegioCool1PulsPropOutput	RegioCool1PulsPropOutput	20026	NO	Puls prop cool 1 valve
RCPActual.RegioCool2IncOutput	RegioCool2IncOutput	20027	NO	Not used
RCPActual.RegioCool2DecOutput	RegioCool2DecOutput	20028	NO	Not used
RCPActual.RegioCool2PulsPropOutput	RegioCool2PulsPropOutput	20029	NO	Not used
RCPActual.RegioHeatCoolIncOutput	RegioHeatCoolIncOutput	20030	NO	Increase Heat cool valve
RCPActual.RegioHeatCoolDecOutput	RegioHeatCoolDecOutput	20031	NO	Decrease Heat cool valve

Signal name	Object name	Instance number	Writeable	Description
RCPActual.RegioHeatCoolPulsPropOutput	RegioHeatCoolPulsPropOutput	20032	NO	Puls prop Heat cool valve
RCPActual.RegioSumAlarm	RegioSumAlarm	20033	NO	Sum alarm
RCPActual.RegioSumAlarmA	RegioSumAlarmA	20034	NO	Sum alarm A
RCPActual.RegioSumAlarmB	RegioSumAlarmB	20035	NO	Sum alarm B
RCPActual.RegioRoomTempControlState	RegioRoomTempControlState	20036	NO	Current controller state 1=Heating, 2=Cooling
RCPActual.RegioSunBlindsState	RegioSunBlindsState	20037	NO	Blind Position 1=In 2=Out
RCPActual.RegioPresence	RegioPresence	20038	NO	Presence indication
RCPActual.RegioCO2Presence	RegioCO2Presence	20039	NO	Is set if presence if CO2 is high
RCPActual.RegioAIChangeOverState	RegioAIChangeOverState	20040	NO	Is set if change over from analog input
RCPActual.RegioChangeOverState	RegioChangeOverState	20041	NO	Is set if change over
RCPActual.RegioRoomTempSensorAlarm	RegioRoomTempSensorAlarm	20042	NO	Is set if sensor alarm on room sensor (Internal or external)
RCPActual.RegioTimeGroupOcc	RegioTimeGroupOcc	20043	NO	Time Group 'Occupied' (No. 1).
RCPActual.RegioTimeGroupUnOcc	RegioTimeGroupUnOcc	20044	NO	Time Group 'Unoccupied' (No. 2).
RCPActual.RegioTimeGroupLighting	RegioTimeGroupLighting	20045	NO	Time Group 'Lighting' (No. 3).
RCPActual.RegioExerciseOnHeat1	RegioExerciseOnHeat1	20085	NO	Valve Heat 1 in exercise
RCPActual.RegioExerciseOnHeat2	RegioExerciseOnHeat2	20086	NO	Valve Heat 2 in exercise
RCPActual.RegioExerciseOnCool1	RegioExerciseOnCool1	20087	NO	Valve Cool 1 in exercise
RCPActual.RegioExerciseOnCool2	RegioExerciseOnCool2	20088	NO	Not used
RCPActual.RegioExerciseOnHeatCool	RegioExerciseOnHeatCool	20089	NO	Valve HeatCool in exercise
RCPActual.RegioDIOpenWindowCombined	RegioDIOpenWindowCombined	20095	NO	Open window indication all Controllers
RCPActual.RegioDICondenseAlarmCombined	RegioDICondenseAlarmCombined	20096	NO	Alarm Condens indication all Controllers
RCPActual.RegioDIPresenceCombined	RegioDIPresenceCombined	20097	NO	Pressens indication all Controllers (This is the combination of all pins not actualy the presence state)
RCPActual.RegioDIChangeoverCombined	RegioDIChangeoverCombined	20098	NO	Change over indication all Controllers
RCPActual.RegioCommFailsafeActive ¹	RegioCommFailsafeActive	20099	NO	Indicates communication Failsafe state
RCPActual.RegioDigIn1Aux ¹	RegioDigIn1Aux	20100	NO	Digital Input 1 value when configured as Ext. Digital Input
RCPActual.RegioDigIn2Aux ¹	RegioDigIn2Aux	20101	NO	Digital Input 2 value when configured as Ext. Digital Input
RCPActual.RegioDigIn3Aux ¹	RegioDigIn3Aux	20102	NO	Digital Input 3 value when configured as Ext. Digital Input

1. Only available for Regio Eedo version 2.0.-1-04 or later

D.3 Analog values

Signal name	Object name	Instance number	Writeable	Description
RCPSettings.RegioHeatSetPointOccupied	RegioHeatSetPointOccupied	30001	YES	Room Base setpoint heating
RCPSettings.RegioCoolSetPointOccupied	RegioCoolSetPointOccupied	30002	YES	Room Base setpoint cooling
RCPSettings.RegioRoomTempPBand	RegioRoomTempPBand	30003	YES	Temperature PID P Band
RCPSettings.RegioRoomTempTime	RegioRoomTempTime	30004	YES	Temperature PID I Time
RCPSettings.RegioHeatSetPointUnoccupied	RegioHeatSetPointUnoccupied	30005	YES	Setpoint heating in Unoccupied
RCPSettings.RegioCoolSetPointUnoccupied	RegioCoolSetPointUnoccupied	30006	YES	Setpoint Cooling in Unoccupied
RCPSettings.RegioSetPointDeadBandStandby	RegioSetPointDeadBandStandby	30007	YES	Deadband in Standby mode
RCPSettings.RegioFrostProtectionSetPoint	RegioFrostProtectionSetPoint	30008	YES	Setpoint frostprotection
RCPSettings.RegioSetPOffsetRemote	RegioSetPOffsetRemote	30009	YES	Setpoint offset remote ¹
RCPSettings.RegioControllerStateBypassTime	RegioControllerStateBypassTime	30011	YES	Time for Bypass mode (Min)
RCPSettings.RegioVAVOutputMinLimitOff	RegioVAVOutputMinLimitOff	30012	YES	Min Limit for VAV Output at off State
RCPSettings.RegioVAVOutputMinLimitUno	RegioVAVOutputMinLimitUno	30013	YES	Min Limit for VAV Output at Unoccupied State
RCPSettings.RegioVAVOutputMinLimitStandby	RegioVAVOutputMinLimitStandby	30014	YES	Min Limit for VAV Output at Stanby State
RCPSettings.RegioVAVOutputMinLimitOcc	RegioVAVOutputMinLimitOcc	30015	YES	Min Limit for VAV Output at Occupied or Bypass State
RCPSettings.RegioVAVOutputMaxLimit	RegioVAVOutputMaxLimit	30016	YES	Max Limit for VAV Output
RCPSettings.RegioChangeOverAIDiffHeat	RegioChangeOverAIDiffHeat	30018	YES	The difference between the temperature in the room and the media temperature for change over to cooling
RCPSettings.RegioChangeOverAIDiffCool	RegioChangeOverAIDiffCool	30019	YES	The difference between the temperature in the room and the media temperature for change over to heating
RCPSettings.RegioSupplyAirTempLimCascadeFactor	RegioSupplyAirTempLimCascadeFactor	30020	YES	Cascade Factor for the Cascade PID
RCPSettings.RegioSupplyAirTempLimHeatMinLimit	RegioSupplyAirTempLimHeatMinLimit	30021	YES	Min Setpoint for the Cascade PID in Heat Mode
RCPSettings.RegioSupplyAirTempLimHeatMaxLimit	RegioSupplyAirTempLimHeatMaxLimit	30022	YES	Max Setpoint for the Cascade PID in Heat Mode
RCPSettings.RegioSupplyAirTempLimCoolMinLimit	RegioSupplyAirTempLimCoolMinLimit	30023	YES	Min Setpoint for the Cascade PID in Cool Mode
RCPSettings.RegioSupplyAirTempLimCoolMaxLimit	RegioSupplyAirTempLimCoolMaxLimit	30024	YES	Max Setpoint for the Cascade PID in Cool Mode
RCPSettings.RegioSupplyAirTempLimFrostProtSetPoint	RegioSupplyAirTempLimFrostProtSetPoint	30025	YES	Supply Air Temp Frost Protection Temperature
RCPSettings.RegioCO2PBand	RegioCO2PBand	30026	YES	CO2 PID P Band
RCPSettings.RegioCO2Time	RegioCO2Time	30027	YES	CO2 PID I Time
RCPSettings.RegioCO2SetPoint	RegioCO2SetPoint	30028	YES	Setpoint for CO2 PI Controller in PPM

Signal name	Object name	Instance number	Writeable	Description
RCPSettings.RegioFanStopTime	RegioFanStopTime	30029	YES	Time (Sec) for the Fan Stop delay when Fan AfterBlow used
RCPSettings.RegioCVHeatExerciseDay	RegioCVHeatExerciseDay	30062	YES	Day for exercise heating and heat/cool valve 1=Never 2-8=mon-sun 9=every day
RCPSettings.RegioCVCoolExerciseDay	RegioCVCoolExerciseDay	30063	YES	Day for exercise cooling valve
RCPSettings.RegioCVHeatExerciseHour	RegioCVHeatExerciseHour	30064	YES	Hour for exercise heating and heat/cool valve
RCPSettings.RegioCVCoolExerciseHour	RegioCVCoolExerciseHour	30065	YES	Hour for exercise cooling valve
RCPSettings.RegioHeatExerciseTime	RegioHeatExerciseTime	30066	YES	Time in seconds to Exercise the Heat Valves
RCPSettings.RegioCoolExerciseTime	RegioCoolExerciseTime	30067	YES	Time in seconds to Exercise the Cool Valves
RCPSettings.RegioAi1Comp	RegioAi1Comp	30074	YES	Analog input 1 compensation
RCPSettings.RegioAi2Comp	RegioAi2Comp	30075	YES	Analog input 2 compensation
RCPSettings.RegioAi3Comp	RegioAi3Comp	30076	YES	Analog input 3 compensation
RCPSettings.RegioInternalTempComp	RegioInternalTempComp	30078	YES	Internal temperature sensor compensation
RCPSettings.RegioHeat1OutputManual	RegioHeat1OutputManual	30092	YES	Manual value Heat 1
RCPSettings.RegioHeat2OutputManual	RegioHeat2OutputManual	30093	YES	Manual value Heat 2
RCPSettings.RegioCoolOutputManual	RegioCoolOutputManual	30094	YES	Manual value Cool
RCPSettings.RegioHeatCoolOutputManual	RegioHeatCoolOutputManual	30095	YES	Manual value Heat Cool
RCPSettings.RegioVAVOutputManual	RegioVAVOutputManual	30096	YES	Manual value VAV
RCPSettings.RegioECFanOutputManual	RegioECFanOutputManual	30097	YES	Manual value ECFan
RCPSettings.RegioRUButtonsUsed	RegioRUButtonsUsed	30121	YES	Buttons that can be used in the RU
RCPSettings.RegioAlarmHyst	RegioAlarmHyst	30124	YES	Alarm hysteresis
RCPSettings.RegioRoomTempHighLimit	RegioRoomTempHighLimit	30125	YES	High room temp
RCPSettings.RegioRoomTempLowLimit	RegioRoomTempLowLimit	30126	YES	Low room temp
RCPSettings.RegioRoomTempMaxDeviationLimit	RegioRoomTempMaxDeviationLimit	30127	YES	Max allowed difference between setpoint and room temp before alarm
RCPSettings.RegioCondenseLimit	RegioCondenseLimit	30132	YES	High limit for condense alarm
RCPSettings.RegioCondenseHyst	RegioCondenseHyst	30133	YES	Condense alarm hysteresis
RCPSettings.RegioCO2MaxLimit	RegioCO2MaxLimit	30136	YES	Max CO2 Level for Alarm
Qsystem.Sec	Sec	30138	YES	System Time Seconds
Qsystem.Minute	Minute	30139	YES	System Time Minutes
Qsystem.Hour	Hour	30140	YES	System Time Hours
Qsystem.WDay	WDay	30141	YES	System WeekDay
Qsystem.Week	Week	30142	YES	System Week
Qsystem.Date	Date	30143	YES	System Date Day
Qsystem.Month	Month	30144	YES	System Date Month

Signal name	Object name	Instance number	Writeable	Description
Qsystem.Year	Year	30145	YES	System Date Year
AlaData.AlaPt1_DelayValue ²	AlaPt1_DelayValue	30146	YES	Delay value for point no. 1 Presence
AlaData.AlaPt2_DelayValue ²	AlaPt2_DelayValue	30147	YES	Delay value for point no. 2 OpenWindow
AlaData.AlaPt3_DelayValue ²	AlaPt3_DelayValue	30148	YES	Delay value for point no. 3 Condensation
AlaData.AlaPt4_DelayValue ²	AlaPt4_DelayValue	30149	YES	Delay value for point no. 4 RoomTempHigh
AlaData.AlaPt5_DelayValue ²	AlaPt5_DelayValue	30150	YES	Delay value for point no. 5 RoomTempLow
AlaData.AlaPt6_DelayValue ²	AlaPt6_DelayValue	30151	YES	Delay value for point no. 6 RoomTempDeviation
AlaData.AlaPt7_DelayValue ²	AlaPt7_DelayValue	30152	YES	Delay value for point no. 7 RoomControllerInManualMode
AlaData.AlaPt8_DelayValue ²	AlaPt8_DelayValue	30153	YES	Delay value for point no. 8 SensorAlarm
AlaData.AlaPt9_DelayValue ²	AlaPt9_DelayValue	30154	YES	Delay value for point no. 9 RoomUnitError
AlaData.AlaPt25_DelayValue ²	AlaPt25_DelayValue	30170	YES	Delay value for point no. 25 CO2 Level High
Alarms.AlaAcknow ²	AlaAcknow	30172	YES	External acknowledge command
Alarms.AlaBlock ²	AlaBlock	30173	YES	External blocking command
Alarms.AlaUnBlock ²	AlaUnBlock	30174	YES	External unblocking command
AlaData.AlaPt27_DelayValue ²	AlaPt27_DelayValue	30175	YES	Delay value for point no. 27 Communication fail safe
AlaData.AlaPt28_DelayValue ²	AlaPt28_DelayValue	30176	YES	Delay value for point no. 28 Hardware Manual Operation
AlaData.AlaPt29_DelayValue ²	AlaPt29_DelayValue	30177	YES	Delay value for point no. 29 External Alarm Digital Input 1
AlaData.AlaPt30_DelayValue ²	AlaPt30_DelayValue	30178	YES	Delay value for point no. 30 External Alarm Digital Input 2
AlaData.AlaPt31_DelayValue ²	AlaPt31_DelayValue	30179	YES	Delay value for point no. 31 External Alarm Digital Input 3
RCPSettings.RegioFailsafetime ²	RegioFailsafetime	30181	YES	Communication failure safe time for triggering Failsafe
AlaData.AlaPt33_DelayValue ³	AlaPt33_DelayValue	30182	YES	Delay value for point no. 33 Battery Failure
RCPSettings.RegioAnalog1Manual-Value ²	RegioAnalog1Manual-Value	30187	YES	Analog Manual Value for Analog Output 1
RCPSettings.RegioAnalog2Manual-Value ²	RegioAnalog2Manual-Value	30188	YES	Analog Manual Value for Analog Output 2
RCPSettings.RegioAnalog3Manual-Value ²	RegioAnalog3Manual-Value	30189	YES	Analog Manual Value for Analog Output 3
RCPSettings.RegioAnalog4Manual-Value ²	RegioAnalog4Manual-Value	30190	YES	Analog Manual Value for Analog Output 4
RegioVAV/OutputMinLimitBypass ²	RegioVAV/OutputMinLimit-Bypass	30196	YES	Min Limit for VAV Output at Bypass State
RCPSettings.RegioUnderfloorHeatingSetpoint ²	RegioUnderfloorHeating-Setpoint	30198	YES	Room Setpoint for underfloor heating
RCPSettings.RegioUnderfloorHeatingPBand ²	RegioUnderfloorHeatingP-Band	30200	YES	Underfloor heating PI Control P Band
RCPSettings.RegioUnderfloorHeatingITime ²	RegioUnderfloorHeatingI-Time	30201	YES	Underfloor heating PI Control I Time
RCPSettings.RegioRemoteUnderfloor-temp ²	RegioRemoteUnderfloor-temp	30202	YES	Communication Underfloor Temperature Value
RCPSettings.RegioUnderfloorHeatingManualValue ²	RegioUnderfloorHeating-ManualValue	30204	YES	Manual Value Underfloor heating
RCPSettings.RegioPropValveUnderfloorHeatingPeriodTime ²	RegioPropValveUnderfloorHeatingPeriodTime	30206	YES	Period time (sec) if puls prop control valves

Signal name	Object name	Instance number	Writeable	Description
RCPSettings.RegioECFanAtForcedVentilation ²	RegioECFanAtForcedVentilation	30216	YES	EC Fan speed at forced ventilation
RCPActual.RegioSoftware	RegioSoftware	40003	NO	Type of Regio software (0=RPC)
RCPActual.RegioVerMajor	RegioVerMajor	40004	NO	Major Version
RCPActual.RegioVerMinor	RegioVerMinor	40005	NO	Minor Version
RCPActual.RegioVerBranch	RegioVerBranch	40006	NO	Branch Version (0=Beta, 1=Official)
RCPActual.RegioRevision	RegioRevision	40007	NO	Revision
RCPActual.RegioRoomTempExt	RegioRoomTempExt	40008	NO	Room temp external sensor
RCPActual.RegioAIChangeOverTemp	RegioAIChangeOverTemp	40009	NO	Change over
RCPActual.RegioOutdoorTemp	RegioOutdoorTemp	40010	NO	Outdoor temp
RCPActual.RegioCondensation	RegioCondensation	40011	NO	Condense
RCPActual.RegioRoomCO2	RegioRoomCO2	40012	NO	Room CO2
RCPActual.RegioRoomRH	RegioRoomRH	40013	NO	Room RH
RCPActual.RegioSupplyAirTemp	RegioSupplyAirTemp	40014	NO	SupplyAir Temperature
RCPActual.RegioAnaOut1	RegioAnaOut1	40015	NO	Analog output 1
RCPActual.RegioAnaOut2	RegioAnaOut2	40016	NO	Analog output 2
RCPActual.RegioAnaOut3	RegioAnaOut3	40017	NO	Analog output 1
RCPActual.RegioAnaOut4	RegioAnaOut4	40018	NO	Analog output 2
RCPActual.RegioHeatSeq1	RegioHeatSeq1	40019	NO	Control valve Heating 1
RCPActual.RegioHeatSeq2	RegioHeatSeq2	40020	NO	Control valve Heating 2
RCPActual.RegioCoolSeq1	RegioCoolSeq1	40021	NO	Control valve Cooling 1
RCPActual.RegioCoolSeq2	RegioCoolSeq2	40022	NO	Not used
RCPActual.RegioHeatCoolOutput	RegioHeatCoolOutput	40023	NO	Control valve Heating/Cooling
RCPActual.RegioVAVOutput	RegioVAVOutput	40024	NO	Control VAV damper
RCPActual.RegioECFanOutput	RegioECFanOutput	40025	NO	Control EC Fan
RCPActual.RegioRoomTemp	RegioRoomTemp	40026	NO	Roomtemp internal or external
RCPActual.RegioFlow ³	RegioFlow	40027	NO	Air flow
RCPActual.RegioPIDSetP	RegioPIDSetP	40029	NO	Setpoint Sent to PID
RCPActual.RegioSetPAdjustment	RegioSetPAdjustment	40030	NO	Setpoint Adjustment
RCPActual.RegioHeatOutput	RegioHeatOutput	40031	NO	Control signal Heating 0-100 %
RCPActual.RegioCoolOutput	RegioCoolOutput	40032	NO	Control signal Cooling 0-100 %
RCPActual.RegioVAVOutputSignal	RegioVAVOutputSignal	40033	NO	Control signal VAV 0-100%
RCPActual.RegioECFanOutputSignal	RegioECFanOutputSignal	40034	NO	Control signal EC fan 0-100%
RCPActual.RegioECFanSpeedIndex	RegioECFanSpeedIndex	40036	NO	Current EC fan speed converted to index 1=Off, 2=Speed1, 3=Speed2, 4=Speed3 used in RU
RCPActual.RegioByPassRunMin	RegioByPassRunMin	40038	NO	Time left in ByPass mode (min)
RCPActual.RegioRoomTempAverage	RegioRoomTempAverage	40067	NO	Average Roomtemp internal or external
RCPActual.RegioAIChangeOverAverage	RegioAIChangeOverAverage	40068	NO	Average Change over Temperature
RCPActual.RegioOutdoorTempAverage	RegioOutdoorTempAverage	40069	NO	Average Temperature from all controllers
RCPActual.RegioCondenseAverage	RegioCondenseAverage	40070	NO	Condense Average

Signal name	Object name	Instance number	Writeable	Description
RCPActual. RegioRoomCO2Average	RegioRoomCO2Average	40071	NO	Average CO2 from all controllers
RCPActual.RegioRoomRHAverage	RegioRoomRHAverage	40072	NO	Average Humidity from all controllers
RCPActual. RegioSupplyAirTempAverage	RegioSupplyAirTempAverage	40073	NO	SupplyAir Temperature from all controllers
RCPActual. RegioSetpointOffsetCombined	RegioSetpointOffsetCombined	40074	NO	Setpoint OffSet , last changed offset from all controllers
RCPActual.RegioAnaln1Aux ²	RegioAnaln1Aux	40107	NO	Analog Input 1 value when configured as Ext. Analog Input
RCPActual.RegioAnaln2Aux ²	RegioAnaln2Aux	40108	NO	Analog Input 2 value when configured as Ext. Analog Input
RCPActual.RegioAnaln3Aux ²	RegioAnaln3Aux	40109	NO	Analog Input 3 value when configured as Ext. Analog Input
RCPActual.RegioUnderfloorTemp ²	RegioUnderfloorTemp	40111	NO	Underfloor Temperature

1. *Setpoint Offset Remote is a write only register affecting the current setpoint offset when writing. It will also only affect the current setpoint offset when the value is changed. Example: User has set +2 from a room unit, The Offset remote register will read anything previously written to it, for example 0 (not showing +2 as might have been expected), To change the offset to 0 it is necessary to write something different from 0 first and then 0 again. The function of this register will be updated in future versions.*
2. *Only available for Regio Eedo version 2.0.-1-04 or later.*
3. *Only available in Regio Eedo version 2.0-1-05 or later*



HEAD OFFICE AB Regin, Box 116, SE-428 22 Källered • Visiting address: Bangårdsvägen 35, SE-428 36 Källered
Phone: +46 (0)31 720 02 00 • Fax: +46 (0)31 720 02 50 • info@regincontrols.com • www.regincontrols.com