

WE TAKE BUILDING
AUTOMATION PERSONALLY

en

MANUAL CORRIGO





THANK YOU FOR CHOOSING REGIN!

Ever since Regin was established in 1947, we have developed and marketed products and systems that create good levels of indoor comfort. Today, we are an important player with one of the market's broadest ranges for building automation.

Our goal is to make real estates in the world more energy efficient. Regin is an international group and our products sells in over 90 countries. Thanks to our global presence with strong local representation, we are well aware of the requirements of the market, as well as of how our products and systems function under the most variable conditions. Every year, Regin makes substantial investments in the development of our systems and HVAC-products.

DISCLAIMER

The information in this manual has been carefully checked and is believed to be correct. Regin makes no warranties about the contents of this manual and users are requested to report errors and discrepancies to Regin, so that corrections may be made in future editions. The information in this document is subject to change without prior notification.

Some product names mentioned in this document are used for identification purposes only and may be the registered trademarks of their respective companies.

© AB Regin. All rights reserved.

Rev. I, 2024-02-14

1	About this manual.....	9
1.1	More information.....	9
2	Introduction to Corrigo	10
2.1	Display	10
2.2	Application tool and Configuration of Corrigo	10
2.3	Internal web interface.....	10
2.4	Comparison between the user interfaces.....	11
3	Information for the end user.....	12
3.1	Display, LED:s and buttons.....	12
3.1.1	Display	13
3.1.2	LED:s.....	13
3.1.3	Summary of the function of the buttons.....	14
3.2	Navigating the menus	14
3.3	Changing values.....	15
3.3.1	Editing an existing value	15
3.3.2	Enter a completely new value	16
3.3.3	Confirm the change	16
3.3.4	Undo an initiated change	16
3.4	Logging on and off.....	16
3.4.1	Log on	16
3.4.2	Log off.....	17
3.4.3	Change password.....	17
3.4.4	Automatic logoff	18
3.5	Menu structure and features.....	18
3.5.1	Ventilation.....	19
3.5.2	Additional function (extra controller)	19
3.5.3	Time settings.....	20
3.5.4	Inputs/Outputs	23
3.5.5	Mode switch	23
3.6	Alarm events and alarm handling.....	23
3.6.1	Alarm priorities	24
3.6.2	Inspect alarms	24
3.6.3	Acknowledge, block and unblock alarms	24
3.7	Internal web interface.....	24
3.7.1	Overview picture.....	25
3.7.2	Log in	26
3.7.3	Homescreen.....	26
3.7.4	Change timer settings.....	29
3.7.5	Setpoints.....	29
3.7.6	Signal analyzer (trend)	30
4	Information for the specialist - Function descriptions	33
4.1	Function overview.....	33
4.2	Temperature control	35
4.2.1	General.....	35
4.2.2	Control modes.....	36
4.3	Temperature sequences	46
4.3.1	Heater (Sequence A).....	47
4.3.2	Exchanger (Sequence B).....	53
4.3.3	Cooler (Sequence C).....	58
4.3.4	Damper sequence	62
4.3.5	Sequence Fan setpoint compensation.....	63
4.3.6	Changeover.....	64
4.3.7	Step controller.....	65
4.3.8	Support control	66

Table of Contents

4.3.9	Free cooling.....	67
4.3.10	Cooling recovery	69
4.3.11	Enthalpy control.....	69
4.3.12	Heat exchanger efficiency monitoring.....	70
4.3.13	External setpoint	71
4.3.14	Recirculation.....	71
4.3.15	Extra temperature sensor	72
4.4	Fan control	73
4.4.1	General.....	73
4.4.2	Fan control types	78
4.4.3	Demand controlled ventilation.....	82
4.4.4	Extra fan motor control	83
4.5	Pump control.....	84
4.5.1	Heating circuit, water heating	84
4.5.2	Exchanger circuit, liquid connected exchangers	84
4.5.3	Cooling circuit.....	85
4.5.4	Settings and configuration in Application tool for pump control	85
4.5.5	Inputs and outputs for pump control	85
4.6	Damper control	85
4.6.1	Close-off dampers.....	85
4.6.2	Fire/smoke dampers	86
4.6.3	Inputs and outputs for dampers.....	88
4.7	Pretreatment	88
4.8	Humidity control	89
4.8.1	Humidification	89
4.8.2	Dehumidification	89
4.8.3	Humidification / Dehumidification	90
4.8.4	Digital humidity signal	90
4.8.5	Settings and configuration for Humidity control	90
4.8.6	Required inputs and outputs for humidity control.....	91
4.9	Filter monitoring	91
4.9.1	Settings and configuration for filter monitoring.....	91
4.10	Extended operation and External stop.....	92
4.11	Time-switch outputs	93
4.12	SFP, Specific Fan Power.....	94
4.13	Extra controller.....	94
4.14	Room unit.....	95
4.15	Energy consumption.....	96
5	Information for the specialist - Configuration	97
5.1	Configuration of the Corrigo	97
5.1.1	Predefined configurations for Corrigo	97
5.1.2	Application tool.....	98
5.2	Work flow for configuration and commissioning the Corrigo	100
5.3	Configuration - System.....	101
5.3.1	General settings.....	101
5.3.2	Port 1 and Port 2.....	103
5.3.3	Modbus slave	104
5.3.4	BACnet	104
5.3.5	CLOUDigo.....	105
5.3.6	Display port	105
5.3.7	Unit settings.....	105
5.3.8	Save and restore.....	106
5.3.9	Controller address (PLA : ELA)	106
5.3.10	IP-configuration.....	107
5.4	Configuration - Device list	107
5.4.1	Fan (Modbus).....	108
5.4.2	Rotary exchanger (Modbus).....	108

5.4.3	Pressure transmitter (Modbus / EXOline)	108
5.4.4	Damper actuator	109
5.4.5	Expansion unit (EXOline)	109
5.4.6	Wireless receiver (Modbus)	110
5.4.7	Room unit (EXOline/Modbus)	110
5.4.8	DX split unit	110
5.5	Configuration - Functions	110
5.5.1	Function activation	111
5.5.2	Sequences	118
5.5.3	Fan control	125
5.5.4	Recirculation	128
5.5.5	Humidity control	128
5.5.6	Filter monitoring	128
5.5.7	Extended operation	129
5.5.8	Pretreatment	129
5.5.9	Extra controller	129
5.5.10	Extra fan motor control	130
5.5.11	Extra indications & outputs	130
5.5.12	Extra sensors & inputs	131
5.5.13	Room unit	131
5.5.14	Alarms	131
5.6	Configuration - Inputs and Outputs	131
5.6.1	Analog inputs, AI	132
5.6.2	Digital inputs, DI	132
5.6.3	Analog outputs, AO	133
5.6.4	Digital outputs, DO	133
5.7	Configuration - Raw values	134
5.8	Ventilation	134
5.8.1	Actual / Setpoint	134
5.8.2	Temperature control	139
5.8.3	Fan control	142
5.8.4	Demand control	144
5.8.5	Fire / Smoke	146
5.8.6	Humidity control	146
5.8.7	PID controllers	146
5.8.8	Energy consumption	147
5.8.9	Manual / Auto	148
5.8.10	Status	152
5.9	Additional function	153
5.9.1	Extra controller	153
5.9.2	Motor control 1 and 2	154
5.10	Inputs / Outputs	154
5.11	Time control	154
5.11.1	Extra time channels	156
5.11.2	Holiday calendar	156
5.11.3	Time settings in display and web interface	157
5.12	Alarm status	157
5.12.1	Alarm handling	157
5.12.2	Alarm configuration	157
5.13	Starting and stopping the Corrigo	158
5.13.1	Start and stop conditions in priority	158
5.13.2	Start sequence	159
5.13.3	Stop sequence	160
5.14	Changing the battery	160
5.14.1	24 V models (Corrigo Ardo)	160
5.14.2	230 V models (Corrigo Vido)	161

Table of Contents

6	Information for the installer.....	162
6.1	Installation	162
6.1.1	Corrigo Ardo (24 V)	162
6.1.2	Corrigo Vido (230 V).....	165
6.1.3	Expansion units EXOline	167
6.2	Commissioning	168
6.2.1	Configuration using Application tool	168
6.2.2	Configuration in the web interface	168
6.3	Loading the application	169
Appendix A	Technical data.....	171
A.1	Corrigo Ardo	171
A.1.1	General data.....	171
A.1.2	Communication ports	171
A.1.3	Inputs & Outputs.....	171
A.2	Corrigo Vido	172
A.2.1	General data.....	172
A.2.2	Communication ports	172
A.2.3	Inputs & Outputs.....	172
Appendix B	Model overview	173
B.1	Corrigo Ardo - Model overview	173
B.2	Corrigo Vido - Model overview	173
Appendix C	Input and output lists	175
C.1	Analog inputs	175
C.2	Digital inputs.....	176
C.3	Universal inputs	177
C.4	Analog outputs	177
C.5	Digital outputs.....	178
Appendix D	Alarm list	181
D.1	181
Appendix E	Terminal lists.....	188
E.1	Corrigo Ardo (24 V models)	188
E.2	Corrigo Vido (230 V models).....	189
Appendix F	Frequency converters and EC controllers for heat exchangers.....	191
F.1	Vacon NXL.....	191
F.2	Lenze.....	192
F.3	Omron V1000.....	192
F.3.1	Parameters	192
F.4	Emerson Commander.....	193
F.4.1	Termination resistor	193
F.4.2	Terminals.....	194
F.4.3	Parameters	194
F.4.4	Changing parameters	194
F.5	LS	195
F.5.1	LS iG5A	195
F.5.2	LS iS7.....	195
F.6	EBM-PAPST	196
F.7	Ziehl EC Blue	196
F.8	Danfoss FC 101	197
F.9	F.XX, ABB.....	197
F.10	Eltwin A/S EC controller (for heat exchangers), RHC 200	197
F.11	VariMax25M.....	198

F.12 F.XX, OJ DRHX 198
F.13 Mitsubishi Heavy (for DX split) 199

I About this manual

This manual covers all the models in the Corrigo series used with the ventilation application. This revision covers software revisions from 5.0.

The manual has the following main chapters:

- ✓ Information for the end user
All the information needed by the end user. How to handle the controller, including how to navigate in the menus, LED:s and indications, how to change setpoints and handle alarms etc.
- ✓ Information for the specialist
A comprehensive guide to all the functions of the controller.
- ✓ Information for the installer
Everything related to the installation of the hardware, such as wiring examples and commissioning.
- ✓ Appendix
Technical data, model overview, input and output lists, alarm list, terminal lists.

Special text formats used in the manual:



Note! This box and symbol is used to show useful tips and tricks.



Caution! This type of text and symbol is used to show cautions.



Warning! This type of text and symbol is used to show warnings.

This box is used to show formulas and mathematical calculations

This box is used to represent the display window on the controller

I.1 More information

More information about the product can be found in:

- ✓ Product sheets for Corrigo Ardo and Corrigo Vido
- ✓ Instructions for Corrigo Ardo and Corrigo Vido
- ✓ Variable lists

All the above documents are available for download from Regin's website, <http://www.regincontrols.com>.

2 Introduction to Corrigo

The Corrigo series of controllers are used for ventilation control. They can be used as a stand-alone controller or integrated in a SCADA system.

There are two versions of the Corrigo with different hardware platforms: The 24 V Corrigo Ardo and the 230 V Corrigo Vido (see more in: *chapter 3.1 Display, LED:s and buttons*)

Corrigo has between 15, 20 and 28 I/O:s depending on hardware and model.

2.1 Display

The Corrigo Ardo is available with or without display. The Corrigo Vido is only available with display.

An external display can be connected to the controller to make it possible to monitor and work with the controller from another location.

The display or the external display is used to e.g. change values, set timers and monitor alarms.

2.2 Application tool and Configuration of Corrigo

Application tool is a PC-based, free configuration software tool, available at Regin's website www.regincontrols.com. The tool is used to configure and commission the controller .

The controller doesn't need to be connected to the computer while configuring. All settings are made in the tool and then uploaded to the controller.

An infinite number of configurations can be stored in the computer memory for later use.

A communication cable is required in order to upload the configuration to the controller. The controller must also be powered up and the application selected in order for it to be configured.

Predefined configurations can be downloaded as atf-files from Regin's website, www.regincontrols.com. These atf-files can be opened in the tool and synchronized to the controller.

More information about configuration is available in: *chapter 5.3 Configuration - System*

2.3 Internal web interface

When the Corrigo is connected to an external display or computer with a browser and a connection to the internet, an internal web interface will be shown. The web interface can be used to change setpoints, configure and monitor the controller.

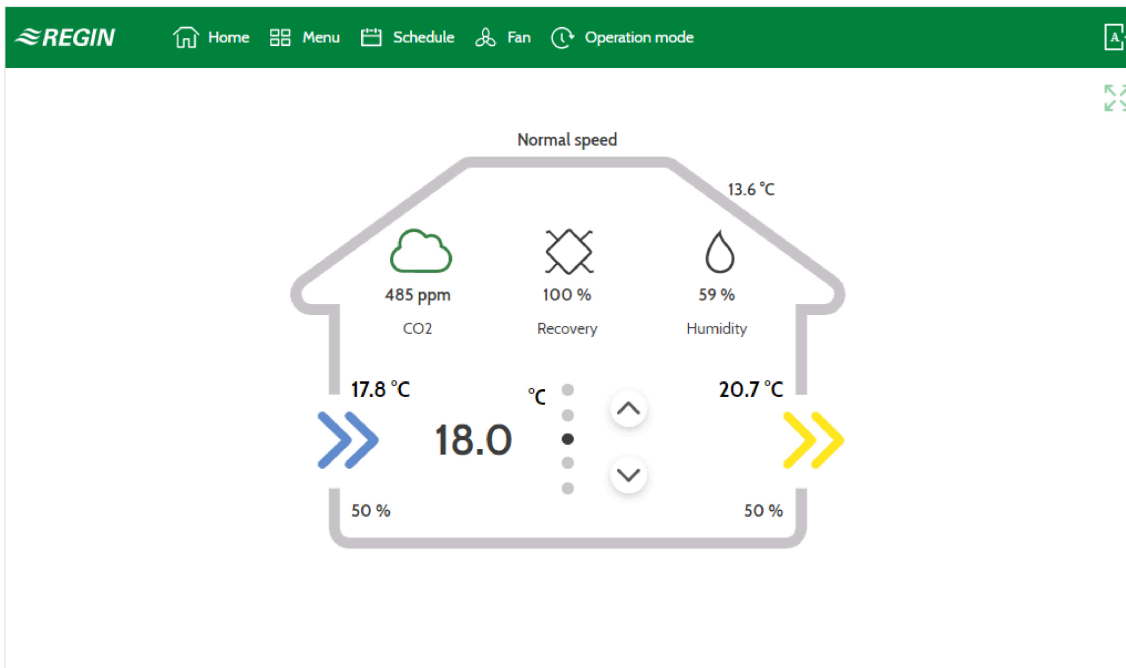

Figure 2-1 Start screen for the web interface

2.4 Comparison between the user interfaces

There are different user interfaces that can be connected to the Corrigo.

The text-displays and the touch screen ED-T43L-V are designed as an end-user interface to show current values, adjust setpoints and timer settings and to adjust settings like limits of control functions and the PID-settings.

The complete configuration can only be done via Application tool or the web-interface.

Table 2-1 User interfaces for Corrigo

	Text display Internal/External	ED-T43L-V (external touch display)	Web interface	Application tool
Actual values /Setpoint	✓	✓	✓	✓
Time channels	✓	✓	✓	✓
Selected settings	✓	✓	✓	✓
Complete settings			✓	✓
Manual control AHU	✓	✓	✓	✓
Manual control components			✓	✓
Configuration of ports	✓	✓	✓	✓
Complete configuration			✓	✓

3 Information for the end user

3.1 Display, LED:s and buttons

The controllers are available in two different hardware platforms:

- ✓ The 230 V Corrigo Vido which features 5 buttons.



Figure 3-1 Corrigo Vido

- ✓ The 24 V Corrigo Ardo which features 7 buttons.









Figure 3-2

3.1.1 Display

The display has 4 rows of 20 characters each. It has background illumination. The illumination is normally off, but is activated as soon as a button is pressed. The illumination will be turned off again after a period of inactivity.

3.1.2 LED:s

On the Corrigo Ardo models, there are two LEDs on the front, marked with the symbols  (alarm) and  (change). For controllers with display, the alarm indication and change mode LEDs are located in the keypad area.





Symbol	Colour	Function
	Flashing red	There are one or more unacknowledged alarms.
	Fixed red	There are one or more remaining acknowledged alarms.
	Flashing yellow	You are in a dialog box where it is possible to switch to change mode. A quick blinking (2 times/s) indicates that the parameter can be changed using the current access level. A slower blinking (1 time/s) indicates that a higher access level is required to change the parameter.
	Fixed yellow	You are in change mode.

Status indication

Status indication LEDs can be found in the upper left corner of the Corrigo Ardo models.

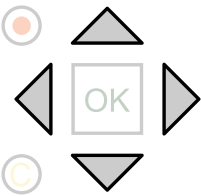
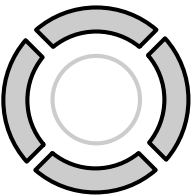
Designation	Colour	Description
P1 RxTx	Yellow/Green	Port 1, receiving/transmitting
P2 RxTx	Yellow/Green	Port 2, receiving/transmitting
TCP/IP (...W models)	Yellow/Green	Green: Connected to other network equipment Blinking green: Network traffic Blinking yellow: For identifying (for example when marking the unit in Application tool)
P/B (Power / Battery)	Green/Red	Power on / Battery error

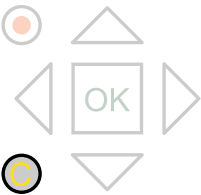
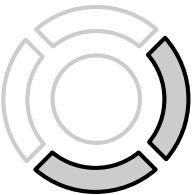
3.1.3 Summary of the function of the buttons

Corrigo Ardo (7 buttons)	Corrigo Vido (5 buttons)	Functions	Function in Alarm Mode
<p>[▲][▼][▶][◀]</p> 	<p>[▲][▼][▶][◀]</p> 	<p>Navigation buttons:</p> <ul style="list-style-type: none"> ▲ Navigate upwards. ▼ Navigate downwards. ▶ Navigate to the right. ◀ Navigate to the left. <p>In change mode:</p> <ul style="list-style-type: none"> ◀ Move cursor to the left. ▶ Move cursor to the right. ▲ Increase the value by 1. ▼ Decrease the value by 1. ▲ and ▼ Scroll among the texts when there are several alternatives. 	<ul style="list-style-type: none"> ▲ Navigate up in the alarm stack. ▼ Navigate down in the alarm stack. ◀ Exit alarm display mode.
<p>[OK]</p> 	<p>[OK]</p> 	<ul style="list-style-type: none"> ✓ Enter change mode. ✓ Confirm a new value in change mode. An input must be confirmed with this button in order to change the value in the controller. <p>When a value has been confirmed, the cursor will move to the next editable value in the current box.</p>	<ul style="list-style-type: none"> ✓ A menu with all actions that are available for the current alarm is displayed.
<p>[C]</p> 	<p>[C]</p>  <p>Press both buttons simultaneously</p>	<ul style="list-style-type: none"> ✓ Enter change mode and erase the value in the display. ✓ Erase the sign at the cursor. ✓ When the current value is completely empty, the edit mode is cancelled and the cursor will move to the next value that will also be erased in the window. ✓ Undo (erase) the input 	<ul style="list-style-type: none"> ✓ Closes the menu containing available alarm actions without changing the state of the alarm point.
<p>[ALARM]</p> 	<p>[ALARM]</p>  <p>Press both buttons simultaneously</p>	<ul style="list-style-type: none"> ✓ Enter alarm display mode. 	<ul style="list-style-type: none"> ✓ Browse among alarms in alarm display mode.

3.2 Navigating the menus

The appearance of the start display may vary since there are several different start displays to choose from during configuration.

```
Vent controller 5.0
2017-01-08 14:29
System: Normal run
Sp: 22.0 Act: 22.5°C
```

Sp and Act stand for Setpoint and Actual value.

Actual value = the current measured temperature

Setpoint = the desired configured temperature

You can navigate through the menu choices at this level by pressing the [▼] and [▲] buttons.

Which menu items that are shown depends on the access level of the user and the configured inputs/outputs and functions.

Below, all possible menu entries are shown.

- ✓ Ventilation
- ✓ Additional function
- ✓ Time settings
- ✓ Alarm events
- ✓ Configuration
- ✓ Access rights

To enter a higher menu level, press the [▶] button when the display marker is located at the menu item you wish to enter. At each level there may be several new menus through which you may browse using the [▲] and [▼] buttons.

When there are further submenus linked to a menu or menu item, it is indicated by an arrow symbol at the right-hand edge of the display. To choose one, press the [▶] button again. To return to a lower menu level, press the [◀] button.

3.3 Changing values

When you are at a position where it is possible to change one or more values, and your access level is high enough, you can edit the existing value, or enter a new one. After changing the value, you confirm the input with the [OK] button, or undo the change by pressing the [C]/ [▼▶] buttons for a short while until the original value reappears in the window and change mode is exited. These actions are described in detail in the following sections.

3.3.1 Editing an existing value

1. Press the [OK] button to go to change mode. A flashing cursor appears. If there are multiple editable values in one menu, press the [OK] button until the value you want to change flashes.
2. Move the cursor to the right and to the left with the navigation buttons [▶] and [◀].
3. The value at the cursor can now be changed in the following ways:
 - ✓ Erase the current digit or character with the [C]/ [▼▶] buttons.
 - ✓ Use the [▲] and [▼] buttons to increase or decrease the value at the cursor. Editable texts can also be changed with this method.
 - ✓ If the character at the cursor is a decimal point, you cannot browse with the [▲] and [▼] buttons. You can however erase the decimal point with the [C]/ [▼▶] buttons.
 - ✓ If the cursor is placed to the right of the value, i.e. the character at the cursor is a space, you can add a decimal point with the [▼] button, or the figure 0 with the [▲] button.
 - ✓ If you require a negative number, move the cursor to the leftmost position and press the [▼] button to get a minus sign. Then edit the following digits to the required value.
 - ✓ Scroll up [▲] and down [▼] to browse through texts when there are several texts to choose from instead of numerical values.

3.3.2 Enter a completely new value

- ✓ Press the [C] / [▼▶] buttons to go to change mode. The value is erased in the window, and you have to enter a completely new value.
- ✓ If you require a negative number, move the cursor to the leftmost position and press the [▼] button to get a minus sign. Then edit the following digits to the required value.
- ✓ Press [▲] to begin the input with the digit 0, then browse to the required digit or character with [▲] and [▼].
- ✓ Press [▼] to get a decimal point. When the cursor is placed at a decimal point, you cannot browse with the [▲] and [▼] buttons.

3.3.3 Confirm the change

Press [OK] to confirm the change when the required value has been entered. Then the value you see in the window will be updated in the installation.

After the value has been confirmed, the cursor will move to the next editable value in the current menu.



Note! As long as you don't confirm a change with the [OK] button, no change will be made in the installation.

3.3.4 Undo an initiated change



Note! As long as you don't confirm a value with the [OK] button, you can undo an initiated change by pressing the [C] / [▼▶] buttons for a short while until the original value reappears in the window and change mode is exited.

3.4 Logging on and off

The controller has four different access levels. The choice of access level determines which menus are shown, as well as which parameters can be changed in the displayed menus.

- ✓ **Guest** level does not require logging on, and only permits changes in running mode and gives read-only access to a limited number of menus.
- ✓ **Operator** level gives the same access as **Guest** level, and in addition, access to change setpoints.
- ✓ **Service** level gives the same access as **Operator** level, and in addition, access to change controller settings and manual mode.
- ✓ **Admin** level gives full read/write access to all settings and parameters in all menus.

3.4.1 Log on

1. Browse to **Access Rights** in the main menu and press [▶].

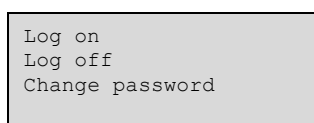

2. Select **Log on** and press **[▶]**.

```
Log on
Enter password:****
Actual level:
None
```

3. Press **[OK]** to make a cursor marker appear at the first digit position.
4. Enter the password (4-digit code) by pressing **[▲]** until the correct digit is displayed. Press the **[▶]** to move to the next position. Repeat the procedure until all four digits are displayed, and press **[OK]** to confirm.

3.4.2 Log off

1. Go to **Access Rights** in the main menu and press **[▶]**.
2. Select **Log off** and press **[▶]**.

```
Log off?
No
Actual level:
Admin
```

3. Select **Yes** and press **[OK]**.

3.4.3 Change password

1. Go to **Access Rights** in the main menu and press **[▶]**.
2. Select **Change password** and press **[▶]**.

```
Change password for
level:Operator
New password: ****
```

3. Select **Yes** and press **[OK]**
4. Press **[OK]** to enter change mode.
5. Use the **[▲]** and **[▼]** buttons to browse and select the access level to change the password for, and press **[OK]** to confirm.

- Enter the new password (4-digit code) by pressing [**▲**] until the correct digit is displayed. Press the [**▶**] to move to the next position. Repeat the procedure until all four digits are displayed, and press [**OK**] to confirm.

The following passwords are the default for the different access levels:

Access level	Password
Admin	1111
Service	2222
Operator	3333
Guest	5555

You can only change the password for access levels lower or equal to the presently active level, i.e. if you are logged in as **Admin** you can change all passwords, but as **Operator** you can only change the **Operator** and **Guest** passwords. There is no point in changing the **Guest** password since access to that level is granted automatically to all users.



Caution! Do not set the password for two different access levels to the same value, as this would prevent access to the higher of these two access levels. This is especially important for the **Admin** level.



Note! If the password for the **Admin** level has been changed and then lost, a temporary password can be obtained from Regin. This code is date dependent and valid for one day only.

3.4.4 Automatic logoff

When logged in as **Operator**, **Service** or **Admin**, the user will automatically be logged off to **Guest** after a settable time of inactivity (the default is 60 seconds). It is possible to disable the automatic logoff in Application tool.

Change password to remove automatic logoff

If you want to remove the automatic logoff, change the password of the desired level to 0000. This can be very useful in certain cases if the unit is intended to be used by trained personnel or, for instance, during commissioning.



Note! Removing the automatic logoff should be done with consideration, since no alarm is continuously given that a certain level has been activated.

3.5 Menu structure and features

The display is not designed to do a complete configuration of the system. It provides access on to **Operator** level and partly access to **Service** settings.

The configuration of the system needs to be done by using Application tool or the web interface.

Start menu:

```
Ventilation
Additional function
Time settings
Alarm events
Inputs/Outputs
Configuration
Access rights
```

3.5.1 Ventilation

Ventilation has up to six submenus:

Actual/Setpoint Temperature control Fan control PID controller Manual/Auto Status
--

Actual/Setpoint

In this submenu, you can read all the actual values of the configured inputs of the circuit. For more information, see *chapter 5 Information for the specialist - Configuration*.

Temperature control

In this submenu, you can read and set all the setpoints for the selected circuit. You need **Operator** or higher access level to be able to change setpoints.

Fan control

In this submenu, settings of the fan can be read and set. It is only visible for access level **Operator** and higher, and only editable for access level **Service** and higher. For more information, see *chapter 5 Information for the specialist - Configuration*

PID control

In this submenu, the control parameters can be read and set. It is only visible for access level **Operator** and higher, and only editable for access level **Service** and higher. For more information, see *chapter 5 Information for the specialist - Configuration*

Manual/Auto

In this submenu, the ventilation unit can be set to manual mode. It is only visible for access level **Operator** and higher, and only editable for access level **Service** and higher.

For more information, see *chapter 5 Information for the specialist - Configuration*.

Status

In this submenu, the status of the ventilation unit can be read.

Each function also has different sub-statuses. For more information, see *chapter 5 Information for the specialist - Configuration*.

3.5.2 Additional function (extra controller)

In this submenu, you can read the actual value and read/write the setpoint of a configured extra controller. For more information, see *chapter 5 Information for the specialist - Configuration*.

3.5.3 Time settings

Corrigo has a year-based clock function. This means that a week-schedule with holiday periods for a full year can be set. The clock has an automatic summertime/wintertime changeover.

It has individual schedules for each weekday plus a separate holiday setting. Up to 24 individual holiday periods can be configured. A holiday period can be anything from one day up to 365 days. Holiday schedules take precedence over other schedules.

Each day has up to four individual running periods. There are daily individual schedules for low speed, normal speed and high speed of the fan, each with up to four running periods.

Up to 4 digital outputs can be used as timer controlled outputs. Each with individual week-schedules with four activation periods per day. These outputs can be used to control lighting, door locks etc.

The **Time settings** menu contains the submenus **Time schedule**, **Holiday schedule** and **Time/Date**.

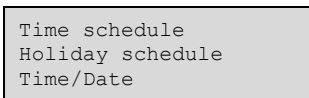

Time settings

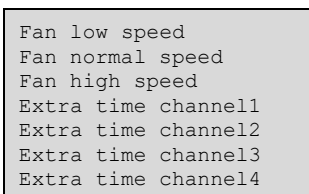

In the time schedules, four periods are available for each day of the week. Also, four periods are available for days that are configured as holidays in the holiday schedule. During the periods the assigned circuit is working with the corresponding setpoint. Outside of a period the system is off.

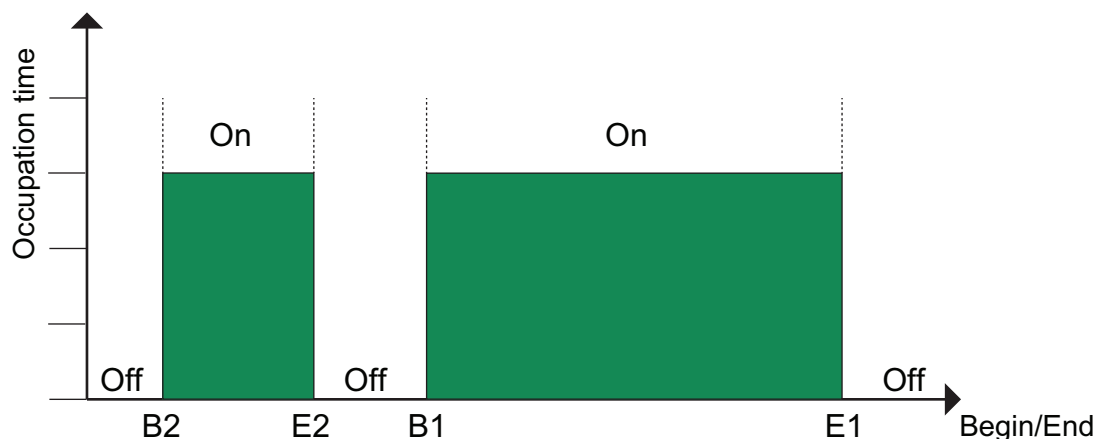

Figure 3-3

The above figure shows an example of period states. It is not possible for periods to overlap each other.

Timer Low speed, Normal speed, High speed

There are sixteen separate settings menus for each timer channel, two for each weekday and two extra for holidays. Holiday schedules take precedence over other schedules.

For 24 hour running, set a period to 00:00 - 24:00.

To inactivate a period, set the time to 00:00 - 00:00. If both periods of a day are set to 00:00 - 00:00, the unit will not run at 1/1-speed that day.

```
Normal speed
Monday Per3-4 >
Per 1: 00:00 - 24:00
Per 2: 00:00 - 00:00
```

```
Normal speed
Monday
Per 3: 00:00 - 00:00
Per 4: 00:00 - 00:00
```

If you want to run the unit from one day to another, e.g. from Monday 22:00 to Tuesday 09:00, the desired running time for both must be entered.

```
Normal speed
Monday
Per 1: 22:00 - 24:00
Per 2: 00:00 - 00:00
```

```
Normal speed
Tuesday
Per 1: 00:00 - 09:00
Per 2: 00:00 - 00:00
```

Should periods for the different speeds overlap, high speed takes precedence over normal speed, and normal speed takes precedence over low speed.

Extra time channels

Up to four digital outputs can be used as timer controlled outputs. Each with individual week-schedules with two activation periods per day. Each output has sixteen separate setting menus; two for each weekday and two extra for holidays. Holiday schedules take precedence over other schedules.

Only the time channels which have been configured, i.e. have been wired to a digital output, will be shown.

```
Extra time channel2
Wednesday Per3-4 >
Per 1: 00:00 - 00:00
Per 2: 00:00 - 00:00
```

```
Extra time channel2
Wednesday
Per 3: 00:00 - 00:00
Per 4: 00:00 - 00:00
```

Extra time channel 4 can be used to control start/stop of the functions:

- ✓ **Extra fan motor control**
- ✓ **Recirculation**

Parameters (Fan normal speed)

Name	Unit	Min	Max	Default	Description
Monday Per.1 Start	hh:mm	00:00	24:00	00:00	Start of period 1 Mondays.
Monday Per.1 End	hh:mm	00:00	24:00	24:00	End of period1 Mondays.
Monday Per.2 Start	hh:mm	00:00	24:00	00:00	Start of period 2 Mondays.
Monday Per.2 End	hh:mm	00:00	24:00	00:00	End of period 2 Mondays.
Monday Per.3 Start	hh:mm	00:00	24:00	00:00	Start of period 3 Mondays.
Monday Per.3 End	hh:mm	00:00	24:00	00:00	End of period 3 Mondays.
Monday Per.4 Start	hh:mm	00:00	24:00	00:00	Start of period 4 Mondays.
Monday Per.4 End	hh:mm	00:00	24:00	00:00	End of period 4 Mondays.
...					
Holiday Per.1 Start	hh:mm	00:00	24:00	00:00	Start of period 1 holidays.
Holiday Per.1 End	hh:mm	00:00	24:00	00:00	End of period 1 holidays.
Holiday Per.2 Start	hh:mm	00:00	24:00	00:00	Start of period 2 holidays.
Holiday Per.2 End	hh:mm	00:00	24:00	00:00	End of period 2 holidays.
Holiday Per.3 Start	hh:mm	00:00	24:00	00:00	Start of period 3 holidays.
Holiday Per.3 End	hh:mm	00:00	24:00	00:00	End of period 3 holidays.
Holiday Per.4 Start	hh:mm	00:00	24:00	00:00	Start of period 4 holidays.
Holiday Per.4 End	hh:mm	00:00	24:00	00:00	End of period 4 holidays.

Parameters (Fan low and high speed, Extra time channels)

Name	Unit	Min	Max	Default	Description
Monday Per.1 Start	hh:mm	00:00	24:00	00:00	Start of period 1 Mondays.
Monday Per.1 End	hh:mm	00:00	24:00	00:00	End of period 1 Mondays.
Monday Per.2 Start	hh:mm	00:00	24:00	00:00	Start of period 2 Mondays.
Monday Per.2 End	hh:mm	00:00	24:00	00:00	End of period 2 Mondays.
Monday Per.3 Start	hh:mm	00:00	24:00	00:00	Start of period 3 Mondays.
Monday Per.3 End	hh:mm	00:00	24:00	00:00	End of period 3 Mondays.
Monday Per.4 Start	hh:mm	00:00	24:00	00:00	Start of period 4 Mondays.
Monday Per.4 End	hh:mm	00:00	24:00	00:00	End of period 4 Mondays.
...					
Holiday Per.1 Start	hh:mm	00:00	24:00	00:00	Start of period 1 holidays.
Holiday Per.1 End	hh:mm	00:00	24:00	00:00	End of period 1 holidays.
Holiday Per.2 Start	hh:mm	00:00	24:00	00:00	Start of period 2 holidays.
Holiday Per.2 End	hh:mm	00:00	24:00	00:00	End of period 2 holidays.
Holiday Per.3 Start	hh:mm	00:00	24:00	00:00	Start of period 3 holidays.
Holiday Per.3 End	hh:mm	00:00	24:00	00:00	End of period 3 holidays.
Holiday Per.4 Start	hh:mm	00:00	24:00	00:00	Start of period 4 holidays.
Holiday Per.4 End	hh:mm	00:00	24:00	00:00	End of period 4 holidays.

Holiday schedule

The system operator can define specific periods of operation or non-operation throughout the year. During these defined periods, the settings in the week schedule do not apply. The holiday schedule provides 24 periods. All holiday periods are working with a special day plan with a maximum of 4 periods.

A holiday period can be any number of consecutive days from 1...365. The dates are in the format: MM:DD.

When the present date falls within a holiday period, the scheduler will use the settings for the weekday **Holiday**.

Parameters

Name	Unit	Min	Max	Default	Description
Holiday Per.1 Start	MM:DD	01.01	31.12	00.00	The start date of holiday period 1.
Holiday Per.1 End	MM:DD	01.01	31.12	00.00	The end date of holiday period 1.
...					
Holiday Per.24 Start	MM:DD	01.01	31.12	00.00	The start date of holiday period 24.
Holiday Per.24 End	MM:DD	01.01	31.12	00.00	The end date of holiday period 24.

Time/Date

This menu displays time, date and weekday, and it permits the setting of time and date.

Time is shown in 24 hour format.

Date is shown in the format YY:MM:DD.

3.5.4 Inputs/Outputs

In the sub menu Inputs/Outputs you can find and modify raw values and analog and digital inputs and outputs. For more information see *chapter 5.6 Configuration - Inputs and Outputs* and *chapter 5.7 Configuration - Raw values*.

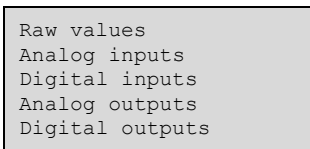

3.5.5 Mode switch

In addition to the items in the main menu, there is also an extra menu called **Mode switch**, that is reached by pressing [►] in the main menu. The mode switch changes the operation of the system.

Mode switch position	
0 — Off	Manual mode Off. System is switched off. No control function.
1 — Auto	Automatic mode. Control function depending on timer and settings.
2 — Low speed	Manual mode. System is forced to low speed of the fans.
3 — Normal speed	Manual mode. System is forced to normal speed of the fans.
4 — High speed	Manual mode. System is forced to high speed of the fans.

3.6 Alarm events and alarm handling

If an alarm condition occurs, an alarm is logged in an alarm list. The list shows the type of alarm, the alarm date and time and the alarm priority (A, B or C alarm).

3.6.1 Alarm priorities

Alarms can be given different priority levels: **A alarm**, **B alarm**, **C alarm** or **not active**. There are three digital outputs that can be used as alarm outputs: **Sum alarm**, **Sum alarm A** and **Sum Alarm B/C**.

- ✓ A, B and C alarms all activate the sum alarm output, if it has been configured.
- ✓ Class A alarms also activate sum alarm A, and class B/C alarms activate sum alarm B/C.
- ✓ Class C alarms are removed from the alarm list when the alarm input resets even if the alarm has not been acknowledged.

3.6.2 Inspect alarms

- ✓ Press the alarm buttons **[ALARM]** / **[◀▲]** to display the alarms.
- ✓ If there is more than one alarm at the same time, this is indicated by up/down arrow symbols at the right-hand edge of the display. You can browse among them in two ways:
 1. By using the navigation buttons **[▼]** and **[▲]**.
 2. By pressing the alarm buttons **[ALARM]** / **[◀▲]** several times.
- ✓ Press **[▶]** to exit alarm handling and return to the previous menu.

3.6.3 Acknowledge, block and unblock alarms

- ✓ Press the **[OK]** button to get a menu with the available alarm actions for the currently displayed alarm.
- ✓ Select the required alarm action with the buttons **[▼]** and **[▲]**.
- ✓ Press the **[OK]** button to execute the action.

At the left end of the bottom display line the alarm status is shown. For active, unacknowledged alarms the space is blank. Alarms that have been reset are indicated by the text **Acknowledged**. Active or blocked alarms are indicated by the text **Acknowledged** or **Blocked**.

Acknowledged alarms will remain on the alarm list until the alarm input signal resets.

Blocked alarms remain on the alarm list until the alarm has been reset and the block has been removed. New alarms of the same type will not be activated as long as the block remains.



Caution! Blocking alarms can be potentially dangerous. A high log on access level is therefore required to block alarms.

Alarm events

In the **Alarm Events** menu, there is an alarm log which contains the 40 latest alarm events. The latest event is shown at the top of the list. The alarm log is only used to view alarm history, which may simplify troubleshooting of the installation.

3.7 Internal web interface

When you connect the controller to a computer or an external display with a browser, you reach the controller's web interface. In the web interface you can monitor the installation and change setpoints etc.

3.7.1 Overview picture

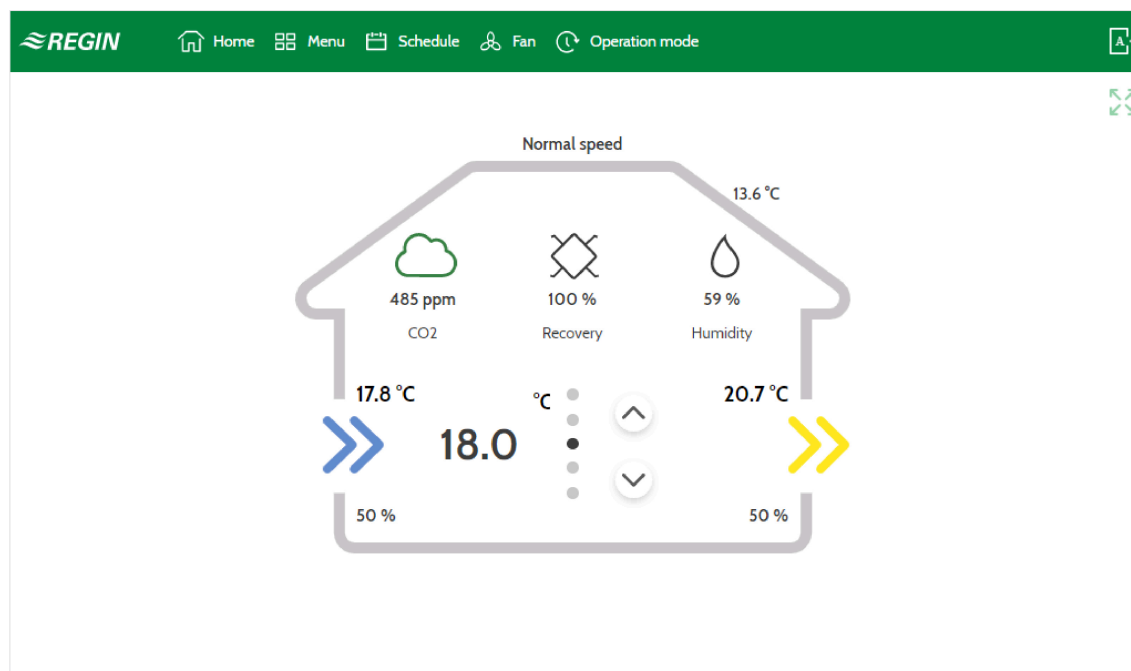

Figure 3-4 Start screen, web interface

In the overview picture you can monitor the actual values in the system:

- ✓ Outdoor temperature
- ✓ Supply air temperature
- ✓ Extract air temperature
- ✓ Main setpoint
- ✓ Fan speed
- ✓ Heating/cooling recovery
- ✓ CO₂ level
- ✓ Humidity
- ✓ Fan signals

The up and down arrows can be used to adjust the current setpoint for e.g. room temperature or extract air depending on the configured type of temperature control.

In the example above (3-4 Start screen, web interface) the values are:

- ✓ Outdoor temperature = 13,6 °C
- ✓ Supply air temperature = 17,8 °C
- ✓ Extract air temperature = 20,7 °C
- ✓ Main setpoint = 18°C
- ✓ Fan speed = Normal speed
- ✓ Heating/cooling recovery = 100 %
- ✓ CO₂ level = 485 ppm
- ✓ Humidity = 59 %
- ✓ Supply air fan speed 50 % (bottom left)

- ✓ Extract air fan speed 50 % (bottom right)

3.7.2 Log in

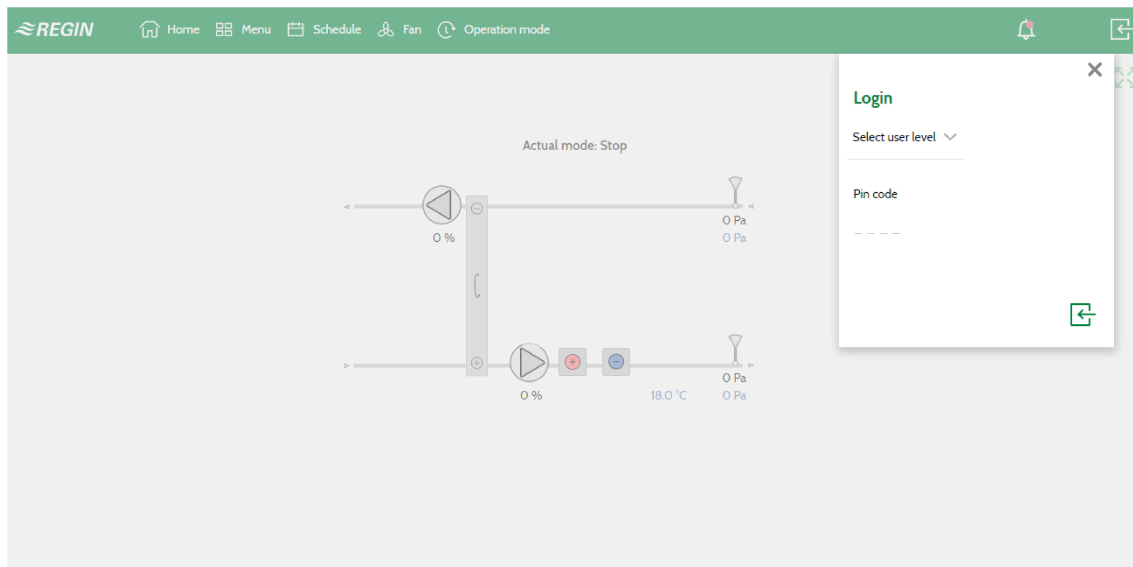

Figure 3-5 Log in to the web interface

1. Press the login symbol in the upper right corner to open the login window.
2. Select the user level and use the correct pin code, see table below:

User level	Pin code
Admin	1111
Service	2222
Operator	3333
Normal	5555

3.7.3 Homescreen

The homescreen can be customized to show either a **Simple view** of the temperature, alarm and time settings (see *Simple view* below) or a **Technical view** with a graphical picture of the system (see *Technical view* below).

To customize the home screen: go to *Menu* ► *Account settings* ► *Homescreen settings*.

Simple view

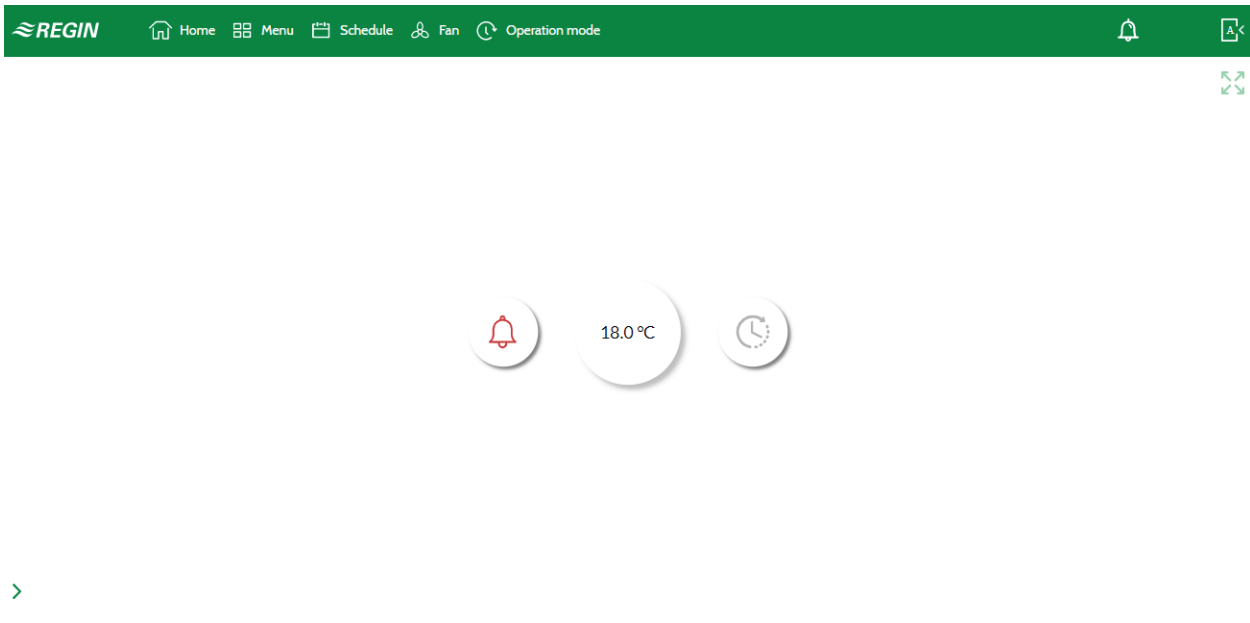



Figure 3-6 Home screen, Simple View

Table 3-1 Symbol explanations, Simple view

Symbol	Description
	<ul style="list-style-type: none"> ✓ Green: No alarm ✓ Red: Active alarm ✓ Yellow: Returned or acknowledged alarm
	<ul style="list-style-type: none"> ✓ Green: Running in <i>Automatic</i> mode ✓ Blue: Forced to a <i>Manual</i> mode (Extended run, Boost or Stop run) ✓ Yellow hand: Any output is in <i>Manual</i> mode

Technical view

In the technical view it is possible to name sensors etc. by pressing the [Edit] button, see *Figure 3-7* below.

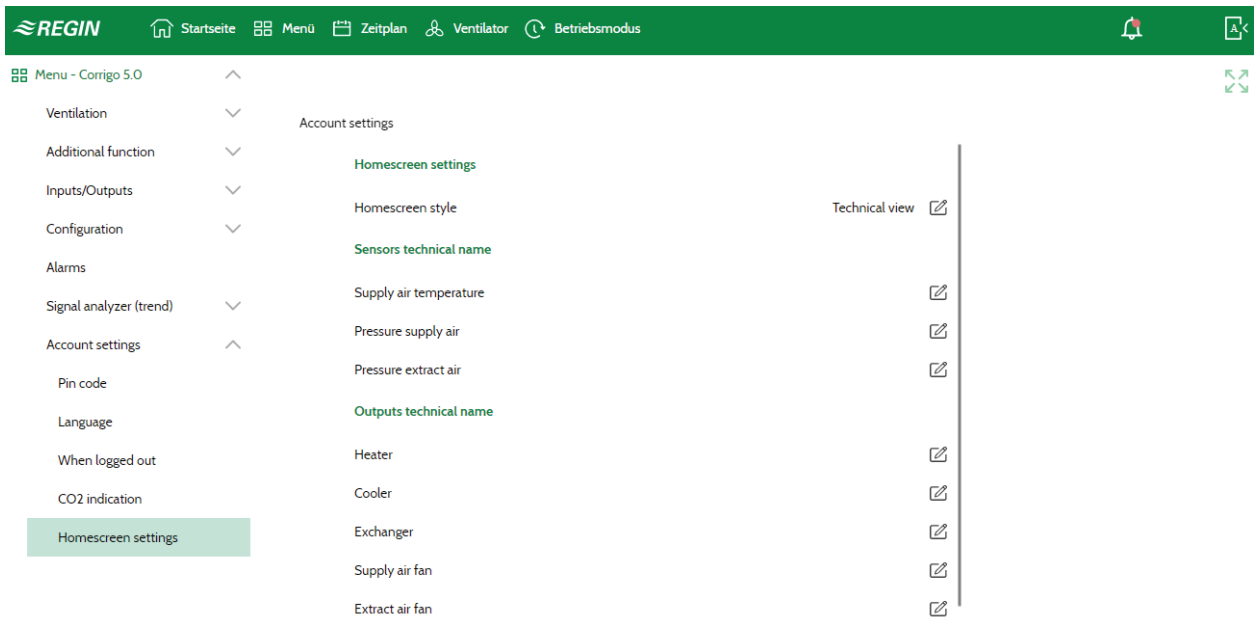

Figure 3-7 Customize technical view

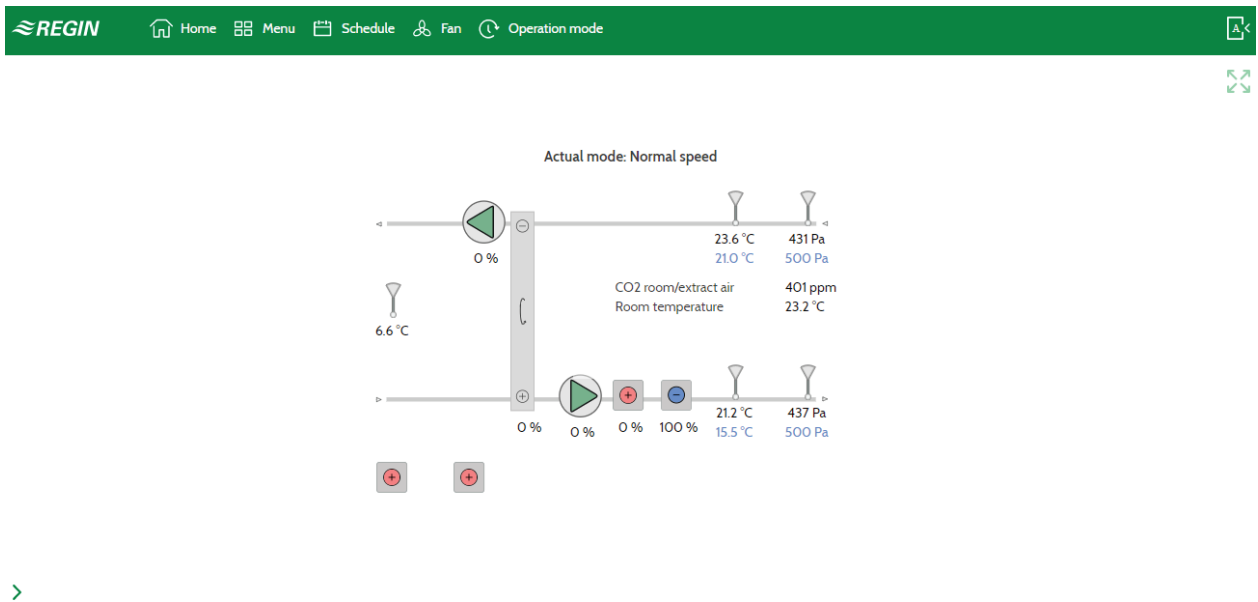

Figure 3-8 Home screen, Technical view

3.7.4 Change timer settings

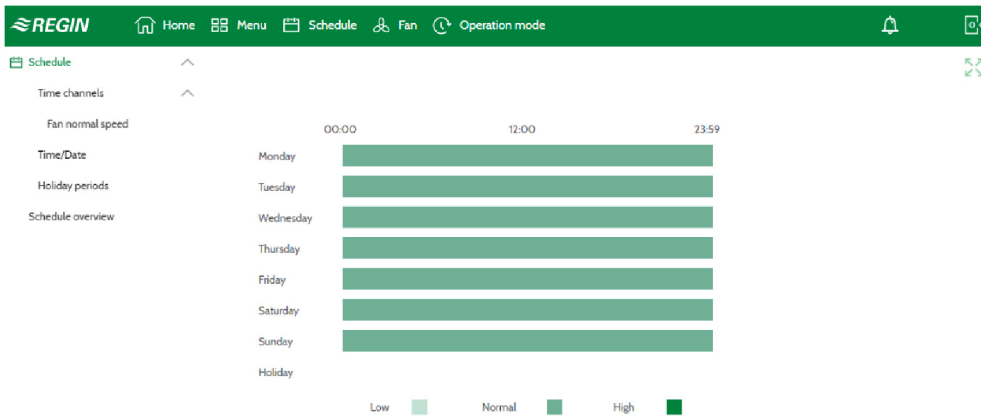

Figure 3-9 Time schedule overview

1. Log in with **Operator** or higher user level
2. Press the **[Schedule]** button in the top menu bar and the schedule overview will open.

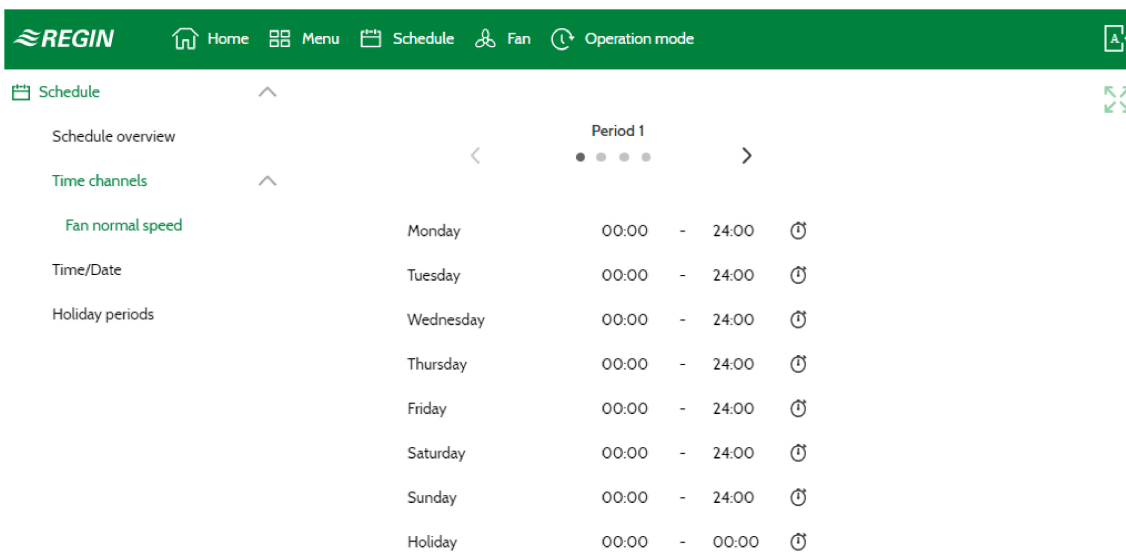

Figure 3-10 Period time settings



Note! The time schedule settings can also be found under **Menu**.

3.7.5 Setpoints

It is possible to read and change setpoints in the web interface as well.

1. Log in as **Operator** or higher.

2. Press the **[Menu]** button in the top menu bar
3. Select **Ventilation ▶ Actual/Setpoint**
4. Select **Temperature** or **Fan** to change setpoints

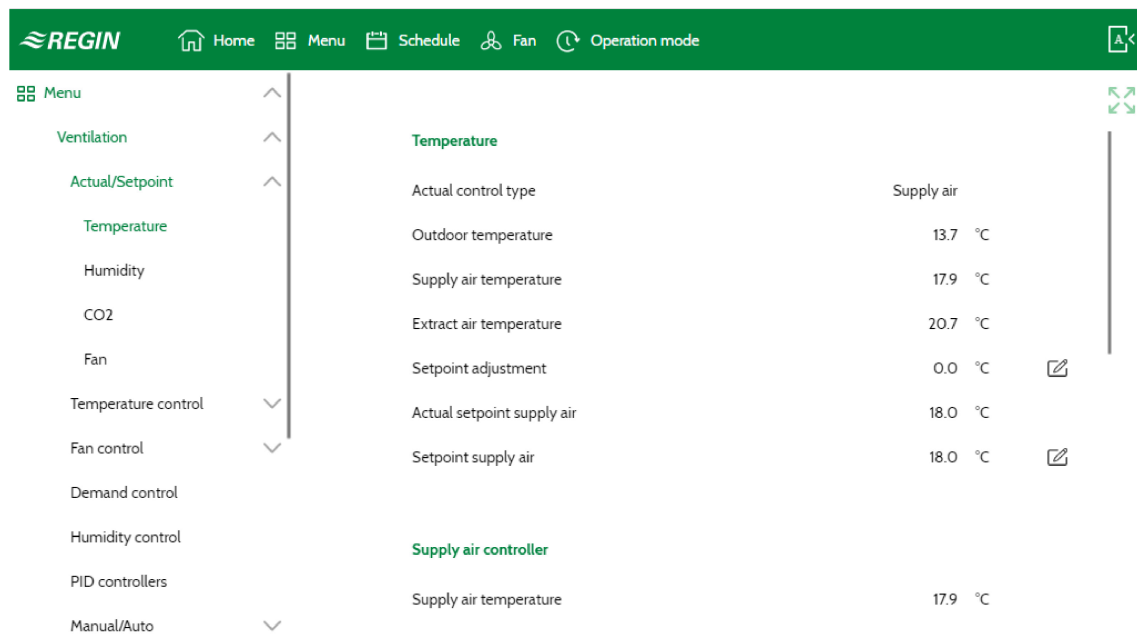

Figure 3-11 Setpoints in web interface

3.7.6 Signal analyzer (trend)

With the signal analyzer it's easy to follow up and look at the history of the analog and digital signals (*Menu ▶ Signal analyzer (trend) ▶ Trend configuration*).

In the Trend configuration, you select which signals you want to follow up, see *Figure 3-12* below. Up to 8 analog signal and 8 digital signals can be logged. Configured inputs and outputs can be selected as well as the output signals of the PID-controllers.

Different modes of operation are available at *Trend configuration ▶ Settings*.

The signal analyzer can run in three different ways:

1. Continuous run
2. Signal triggered
3. Time triggered

Type	Description
Continuous run	Continuous logging
Signal triggered	Triggered by a configured digital signal it is possible to select which change on the selected signal will trigger the logging: <ul style="list-style-type: none"> ✓ falling edge ✓ rising edge ✓ any edge (<i>Trigger signal edge</i>) The logging will stop after a defined time (<i>Stop after time</i>).
Time triggered	Triggered by time and date The logging will stop after a defined time (<i>Stop after time</i>).

The parameter *Type of calculation* is used to calculate the stored values of the analog signals of the last day and last week:

- ✓ Single sample: The current value of the signal is stored.
- ✓ Average: The average of the signal since the last storage is logged.

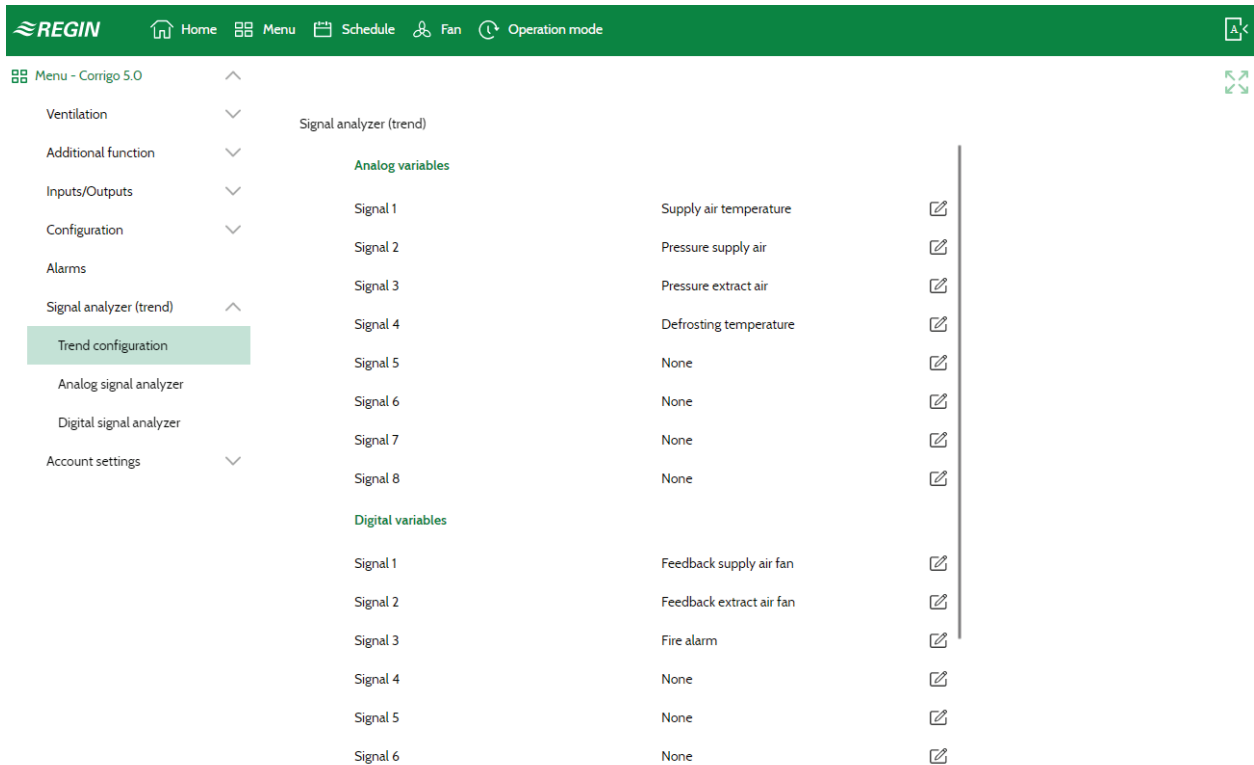

Figure 3-12 Configuration of signal analyzer

The signal analyzer curve shows how the signal varies over time.

For the analog signal it's possible to change the limits on the left and right axis. In the example below (Figure 3-13), the left axis is temperature in °C and the right axis is pressure in Pa.

The signal analyzer stores the historical information in different resolution:

- ✓ Last hour – 10 second interval
- ✓ Last day – 15 minutes interval
- ✓ Last week – 1 hour interval

It's possible to switch between the different resolutions in the chart by pressing the green buttons in the middle below the chart (10 s, 15 m or 1 h). In the examples below, 10 s are selected.

The green arrows on the left side and right side are used to scroll through the timeline.

The information in the diagram will be updated once a minute or can be manually done by pressing the **[refresh]** button.

The **[trash]** button is used to delete all historical data and start from the beginning.

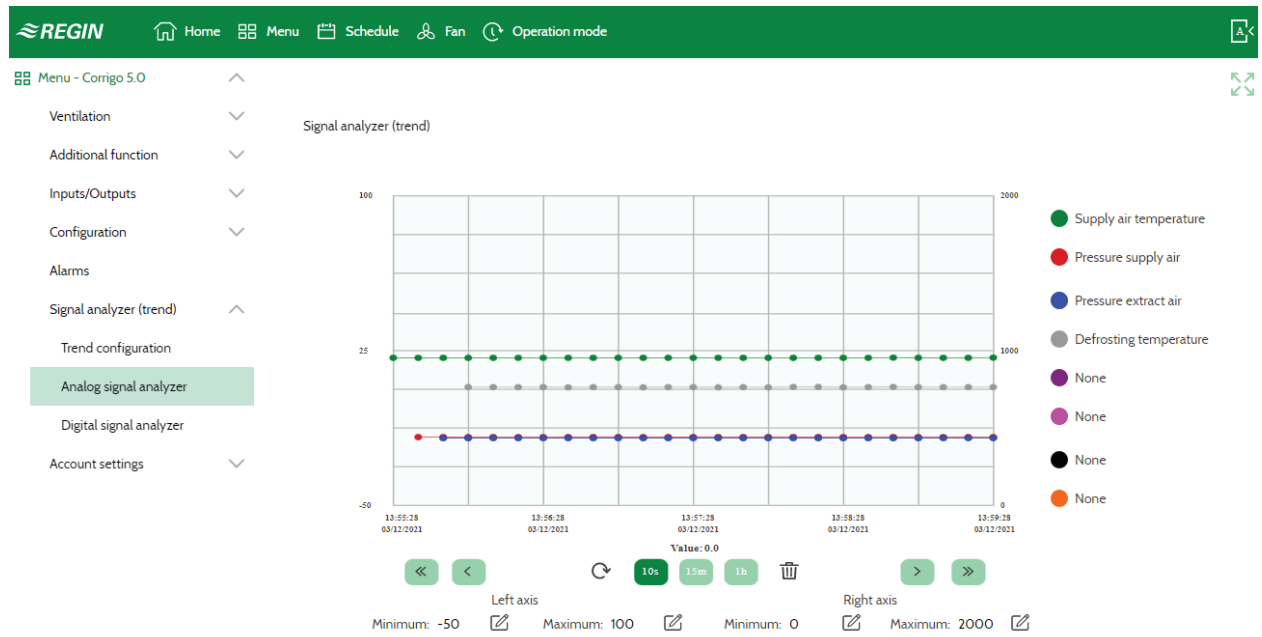

Figure 3-13 Signal analyzer, analog signal

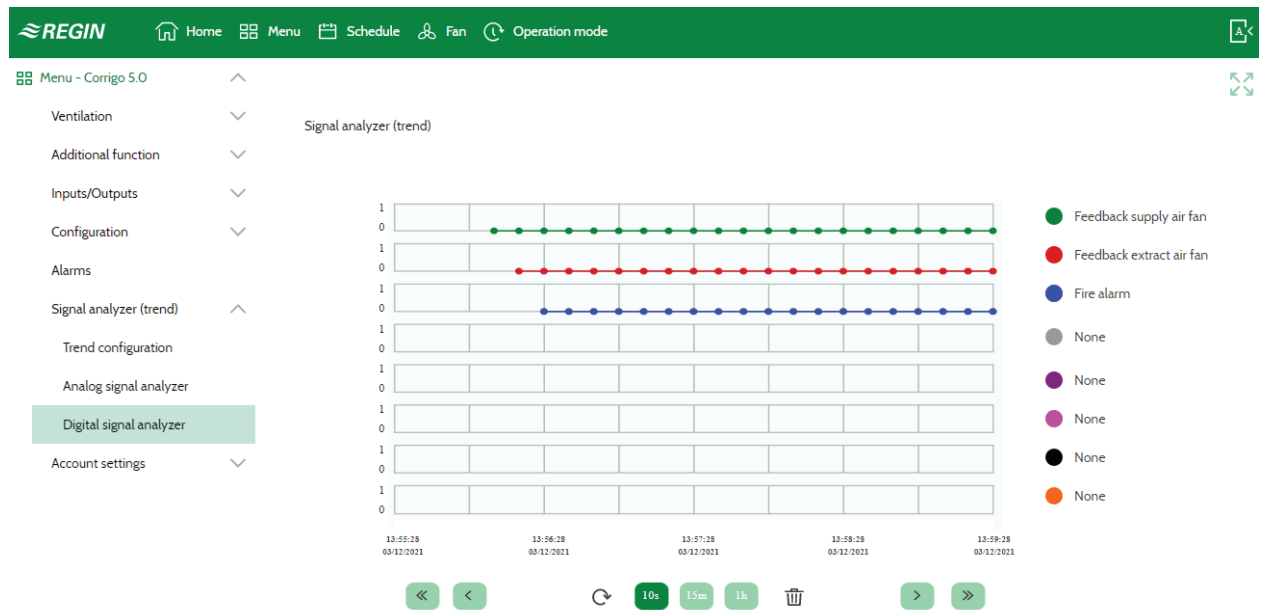

Figure 3-14 Signal analyzer, digital signal

4 Information for the specialist - Function descriptions

4.1 Function overview

A number of different control functions as well as analogue and digital in- and output functions can be found in this controller. Certain functions are necessary, while others can be considered optional. The choice of which functions are to be used is free. The only restriction is the physical number of inputs and outputs of the different models. Information about configuration for the different functions is found in 5 *Information for the specialist - Configuration*.

The program for an air handling unit contains, apart from other things, the following functions:

Different temperature control modes

- ✓ Supply air temperature control, with or without outdoor temperature compensation
- ✓ Room temperature control (cascade control)
- ✓ Extract air control (cascade control)
- ✓ Seasonal switching between supply air temperature control and room/extract air temperature control
- ✓ Outdoor compensated room/extract air control
- ✓ Extract air depending supply air temperature

With control of:

- ✓ Heat exchangers (liquid connected, plate or rotating)
- ✓ Mixing dampers
- ✓ Heating coil (water with or without frost protection, electric with high temperature limit switch, DX or combi coil)
- ✓ Cooling (water, DX with or without exchanger control)
- ✓ Circulation pumps

Fan control

- ✓ 1-, 2- or 3-speed supply air and extract air fans
- ✓ Frequency controlled supply and extract air fans with pressure or flow control, manual control or external control from a VAV system
- ✓ Pressure controlled supply air fan with slave connected extract air fan (output dependent or flow dependent) or opposite function (pressure controlled extract air fan with slave connected supply air fan, output dependent or flow dependent)

Humidity control

It is possible to use either humidification or dehumidification, or to use combined humidification and dehumidification.

Timer control

For starting and stopping the unit, annual clock function. Up to 4 timer outputs for control of external functions such as lighting, door locks etc.

Demand controlled ventilation

In buildings with strongly varying occupancy, the fan speeds or mixing dampers can be controlled by the air quality measured by a CO₂ sensor.

Support control

When using the control function room control or extract air temperature control, it is possible to utilise support-heating and/or support-cooling.

Free cooling

When this function has been activated, it is used during the summer to cool the building during the night using cool outdoor air, thereby reducing the need to run chillers during the day.

Free heating

If the outdoor temperature is higher than the indoor temperature and there is a heating demand, the recovery damper will not open for recovery but instead open fully for outdoor air. This may occur during low night-time outdoor temperatures, when the room has been cooled considerably and the outside heat is rising faster than indoors. This function is activated at the same time as **Free cooling**.

Enthalpy control

Measures and compares the energy content (enthalpy) of the outdoor air and the extract air (temperature and air humidity). When this function is active, the mixing damper signal will be overridden to recirculation if the enthalpy is higher outdoors than indoors.

Pretreatment

Damper and pump control for preheating or precooling of the outdoor air via an underground intake channel.

Cooling recovery

If the extract air is colder than the outdoor air and cooling is required, the heat exchanger control is reversed in order to return the cool extract air.

Recirculation control

Recirculation of air using a supply air fan and (optionally) extract air fan and a recirculation damper with or without temperature control. Used as a recovery function or during heating with support control during the night. Recirculation control is available as an analogue or a digital function.

Step controllers heating/cooling

There are 2 equal step controllers. Both controllers will have 4 steps and can be configured as sequential control or binary control.

Changeover

In 2-pipe systems where a combination heater/cooler is operating together with a heat pump, changeover is a function that enables using the same pipe for both heating and cooling, depending on which is currently required.

4.2 Temperature control

4.2.1 General

Corrigo has a choice of the following control modes:

1. Supply air
2. Supply air outdoor compensated
3. Room cascade
4. Extract air cascade
5. Room (summer) else outdoor compensated supply air
6. Extract air (summer) else outdoor compensated supply air
7. Room outdoor compensated
8. Extract air outdoor compensated
9. Extract air dependent supply air

The supply air temperature controller is reverse acting, i.e. the output will increase for decreasing temperature. The controller is a PID-controller with settable P-band, I-time and D-time.

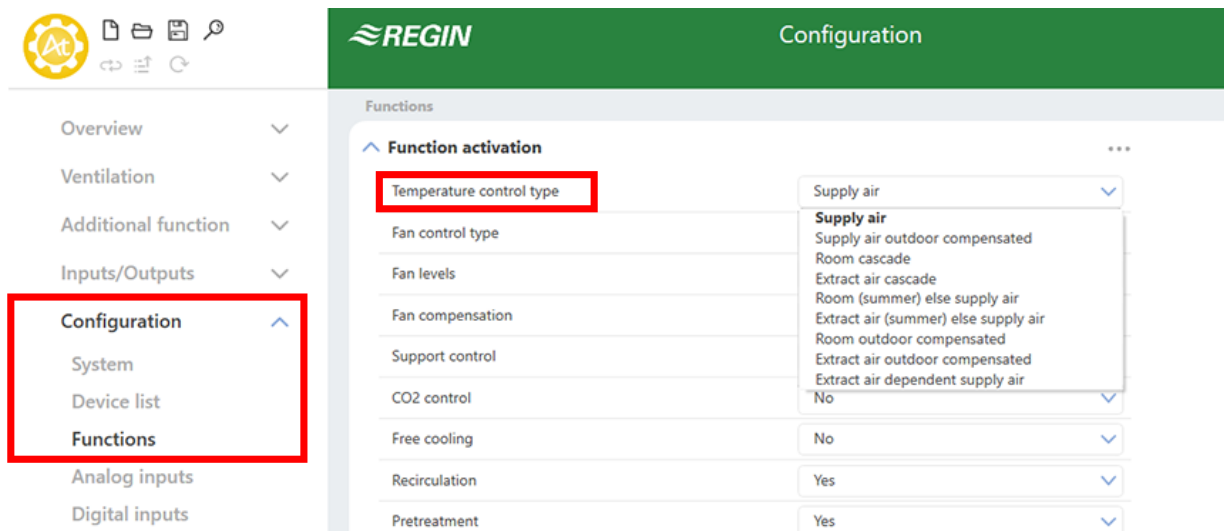

Figure 4-1 Application tool menu path to temperature control

In the first mode, the temperature at the supply air sensor will be constantly kept at the user setpoint value. In the second mode, the supply air temperature setpoint is adjusted depending on the outdoor temperature.

In modes three and four the supply air is controlled as part of a cascade controller together with the room/extract temperature controller. The room/extract temperature offset will dictate the supply air temperature setpoint.

Mode five and six vary according to the outdoor temperature: Outdoor temperature compensated supply air control, as in mode two, in winter and cascaded room control or cascaded extract air control in summer, as in modes three or four. The switch-over temperature is settable.

A neutral zone can be set around the setpoint value.

Example: If the setpoint is 18 °C and the neutral zone is 2 K, the cooling setpoint will be 19 °C and the heating setpoint will be 17 °C (FS=0 K). If the supply air temperature is in the neutral zone, the heating and cooling will be blocked. If the supply air temperature decreases below the setpoint $-NZ/2$ the heating signal will be active until setpoint is fulfilled. If the supply air temperature increases above the setpoint $+NZ/2$ the cooling signal will be active until setpoint is fulfilled.

Alarms which are activated when the supply air temperature is too high or too low are active.

Alarm for control offset of the supply air temperature is active.

4.2.2 Control modes

Read more about configuration of the control modes in chapter 5.6, *Temperature control type*

Supply air control

The supply air temperature is kept at the setpoint value by controlling the output signals for sequences A to J. A single PI control loop is used.

The actual setpoint for the supply air temperature will be limited to a settable minimum and maximum.

Settings and configuration for Supply air control

Table 4-1 Path to configuration and settings for Supply air control

Feature	Menu path in Application tool	Variable	Note
Supply air control	Configuration ► Functions ► Function activation	Temperature control type	Selection of temperature control
Sequence configuration	Configuration ► Functions ► Sequence A to J		
Starting order heating/cooling	Configuration ► Functions ► Sequence heating and Sequence cooling		
Add supply air temperature sensor	Configuration ► Functions ► Temperature control	Supply air temperature sensor (Yes/ No) (
Configure input	Configuration ► Analog inputs ► Supply air temperature		
Sensor type selection	Configuration ► Analog inputs ► Supply air temperature	Sensor type	
Controller output	Ventilation ► Actual / Setpoint ► Supply air controller	Controller output (%)	
Neutral zone setting	Ventilation ► Actual / Setpoint ► Supply air controller	Neutral zone (C°)	
Min / Max limit supply air	Ventilation ► Actual / Setpoint ► Supply air controller	Min / Max limit supply air (C°)	
Setpoint supply air	Ventilation ► Actual / Setpoint ► Supply air controller	Setpoint supply air	

Required inputs for Supply air control

Inputs and outputs	Menu path in Application tool	Name	Settings
AI	Configuration ► Analog inputs	Supply air temperature	<ul style="list-style-type: none"> ✓ Terminal ✓ Name ✓ Sensor type ✓ Filter factor ✓ Compensation (°C) ✓ Mode ✓ Manual (°C)

Supply air outdoor compensated

The supply air temperature setpoint is temperature compensated using a control curve with 8 node points, see *Figure 4-2 Temperature compensation curve* below.



Figure 4-2 Temperature compensation curve

The default settings for the 8 node points are shown in *Table 4-2* below:

Table 4-2 Default settings for compensation curve

Outdoor temperature (°C)	Setpoint supply temperature
-20	25
-15	24
-10	23
-5	23
0	22
5	20
10	18
15	18

The supply air temperature is kept at the setpoint value by controlling the output signals for sequence A to J. A single PI control loop is used.

Alarms which are activated when the supply air temperature is too high or too low are active.

Alarm for control offset of the supply air temperature is active.

Settings and configuration for Supply air outdoor compensated control

Table 4-3 Path to configuration and settings for Supply air outdoor compensated

Feature	Menu path in Application tool	Variable	Note
Supply air outdoor compensated control	Configuration ► Functions ► Function activation	Temperature control type	Selection of temperature control
Sequence configuration	Configuration ► Functions ► Sequence A to J		

Table 4-3 Path to configuration and settings for Supply air outdoor compensated (continued)

Feature	Menu path in Application tool	Variable	Note
Starting order heating/cooling	Configuration ► Functions ► Starting order heating and Starting order cooling		
Add supply air temperature sensor	Configuration ► Functions ► Temperature control	Supply air temperature sensor (Yes/ No)	
Configure input	Configuration ► Analog inputs ► Supply air temperature		
Sensor type selection	Configuration ► Analog inputs ► Supply air temperature	Sensor type	
Controller output	Ventilation ► Actual / Setpoint ► Supply air controller	Controller output (%)	
Setpoint outdoor curve (X, Y)	Ventilation ► Actual / Setpoint ► Supply air controller		
Neutral zone setting	Ventilation ► Actual / Setpoint ► Supply air controller	Neutral zone (C°)	
Min / Max limit supply air	Ventilation ► Actual / Setpoint ► Supply air controller	Min / Max limit supply air (C°)	

Required inputs for Supply air outdoor compensated

Inputs	Menu path in Application tool	Name	Settings
AI	Configuration ► Analog inputs	<ul style="list-style-type: none"> ✓ Supply air temperature ✓ Outdoor temperature 	<ul style="list-style-type: none"> ✓ Terminal ✓ Name ✓ Sensor type ✓ Filter factor ✓ Compensation (°C) ✓ Mode ✓ Manual (°C)

Room cascade

Cascade control of room temperature and supply air temperature to achieve a constant, settable room temperature. The room controller output signal (0-100%) generates the supply air controller's setpoint value between min and max supply setpoint.

Up to 16 room sensors can be connected. A final value will be calculated from the values of the configured room sensors. Different types of calculation are available, such as:

- ✓ select the lowest value
- ✓ select the highest value
- ✓ calculated the average
- ✓ calculate the average with the lowest and the highest value
- ✓ calculate the middle value (median)

The room temperature is kept at the setpoint value by controlling the output signals for A to J. Two PI loops are used.

Settings and configuration for Room cascade control

Table 4-4 Path to configuration and settings for Room cascade

Feature	Menu path in Application tool	Variable	Note
Room cascade control	Configuration ► Functions ► Function activation	Temperature control type	Selection of temperature control
Sequence configuration	Configuration ► Functions ► Sequence A to J		
Starting order heating/cooling	Configuration ► Functions ► Starting order heating and Starting order cooling		
Add room temperature sensor	Configuration ► Functions ► Temperature control	Room temperature sensor	0...16
Select the type of average calculation	Configuration ► Functions ► Temperature control	Room temperature average	Type of average calculation
Setting of P-band and I-time	Ventilation ► PID controllers ► Room		
Setpoint room temperature	Ventilation ► Actual / Setpoint ► Room controller	Setpoint room temperature	
Setpoint adjustment	Ventilation ► Actual / Setpoint ► Room controller	Setpoint adjustment	

Required inputs for Room cascade

Inputs	Menu path in Application tool	Name	Settings
AI	Configuration ► Analog inputs	<ul style="list-style-type: none"> ✓ Room temperature 1...16 ✓ Supply air temperature 	<ul style="list-style-type: none"> ✓ Terminal ✓ Name ✓ Sensor type ✓ Filter factor ✓ Compensation (°C) ✓ Mode ✓ Manual (°C)

Extract air cascade

Cascade control of extract air temperature and supply air temperature to achieve a constant, settable room temperature. The extract air controller output signal (0-100%) generates the supply air controller's setpoint value between min and max supply setpoint.

The extract air temperature is kept at the setpoint value by controlling the output signals for A to J. Two PI loops are used.

Settings and configuration for Extract air cascade control

Table 4-5 Path to configuration and settings for Extract air cascade

Feature	Menu path in Application tool	Variable	Note
Extract air cascade control	Configuration ► Functions ► Function activation	Temperature control type	Selection of temperature control
Sequence configuration	Configuration ► Functions ► Sequence A to J		
Starting order heating/cooling	Configuration ► Functions ► Starting order heating and Starting order cooling		
Add extract air temperature sensor	Configuration ► Functions ► Temperature control	Extract air temperature sensor	Yes / No

Table 4-5 Path to configuration and settings for Extract air cascade (continued)

Feature	Menu path in Application tool	Variable	Note
Configure Input	Configuration ► Analog inputs ► Extract air temperature		
Setting of P-band and I-time	Ventilation ► PID controllers ► Extract air		
Setpoint extract air temperature	Ventilation ► Actual / Setpoint ► Extract air controller	Setpoint extract air	
Setpoint adjustment	Ventilation ► Actual / Setpoint ► Extract air controller	Setpoint adjustment	

Required inputs for Extract air cascade

Inputs	Menu path in Application tool	Name	Settings
AI	Configuration ► Analog inputs	<ul style="list-style-type: none"> ✓ Extract air temperature ✓ Supply air temperature 	<ul style="list-style-type: none"> ✓ Terminal ✓ Name ✓ Sensor type ✓ Filter factor ✓ Compensation (°C) ✓ Mode ✓ Manual (°C)

Room (summer) else supply air outdoor compensated

Summer mode dependent switching between outdoor compensated supply air temperature control and room cascade control.

When the summer mode function is off, outdoor temperature compensated supply air temperature control will be active. In summer mode it will be cascaded room temperature control that is active. The summer mode function is used for switching control mode.

Settings and configuration for Room (summer) else supply air

Table 4-6 Path to configuration and settings for Room (summer) else supply air

Feature	Menu path in Application tool	Variable	Note
Room (summer) else supply air control	Configuration ► Functions ► Function activation	Temperature control type	Selection of temperature control
Sequence configuration	Configuration ► Functions ► Sequence A to J		
Starting order heating/cooling	Configuration ► Functions ► Starting order heating and Starting order cooling		
Summer mode settings	Configuration ► Functions ► Temperature control	Activate summer mode	
Add supply air temperature/ room temperature sensor	Configuration ► Functions ► Temperature control	Supply air temperature sensor (Yes/ No / Room temperature sensor (1...16))	
Configure Input	Configuration ► Analog inputs ► Supply air temperature		
Sensor type selection	Configuration ► Analog inputs ► Supply air temperature		
Setting of P-band and I-time	Ventilation ► PID controllers ► Room		
Setpoint room temperature	Ventilation ► Actual / Setpoint ► Room controller	Setpoint room temperature	

Required inputs for Room (summer) else supply air

Inputs	Menu path in Application tool	Name	Settings
AI	Configuration ► Analog inputs	<ul style="list-style-type: none"> ✓ Supply air temperature ✓ Room temperature 1...16 ✓ Outdoor temperature 	<ul style="list-style-type: none"> ✓ Terminal ✓ Name ✓ Sensor type ✓ Filter factor ✓ Compensation (°C) ✓ Mode ✓ Manual (°C)

Extract air (summer) else supply air outdoor compensated

Summer mode dependent switching between outdoor compensated supply air temperature control and extract air cascade.

When the summer mode function is off, outdoor temperature compensated supply air temperature control will be active, otherwise cascaded extract temperature control as in control mode 4. Summer mode function is used for switching control mode.

Settings and configuration for Extract air (summer) else supply air

Table 4-7 Path to configuration and settings for Extract air (summer) else supply air outdoor compensated

Feature	Menu path in Application tool	Variable	Note
Extract air (summer) else supply air control	Configuration ► Functions ► Function activation	Temperature control type	Selection of temperature control
Sequence configuration	Configuration ► Functions ► Sequence A to J		
Starting order heating/cooling	Configuration ► Functions ► Starting order heating and Starting order cooling		
Summer mode settings	Configuration ► Functions ► Temperature control	Activate summer mode	
Add extract air temperature sensor	Configuration ► Functions ► Temperature control	Supply air temperature sensor (Yes/ No / Room temperature sensor (1...16))	
Configure Input	Configuration ► Analog inputs ► Extract air temperature		
Sensor type selection	Configuration ► Analog inputs ► Supply air temperature		
Setting of P-band and I-time	Ventilation ► PID controllers ► Extract air		
Setpoint extract air temperature	Ventilation ► Actual / Setpoint ► Extract air controller	Setpoint extract air	

Required inputs for Extract air cascade (summer) else supply air

Inputs	Menu path in Application tool	Name	Settings
AI	Configuration ► Analog inputs	<ul style="list-style-type: none"> ✓ Extract air temperature ✓ Supply air temperature ✓ Outdoor temperature 	<ul style="list-style-type: none"> ✓ Terminal ✓ Name ✓ Sensor type ✓ Filter factor ✓ Compensation (°C) ✓ Mode ✓ Manual (°C)

Room outdoor compensated

Cascade control of the room temperature and supply air temperature to achieve an outdoor compensated room temperature.

The room temperature setpoint is temperature compensated using a control curve with 8 node points, see the curve below in *Figure 4-3 Temperature compensation curve*.

The default settings for the 8 node points are shown in table *Table 4-8* below:

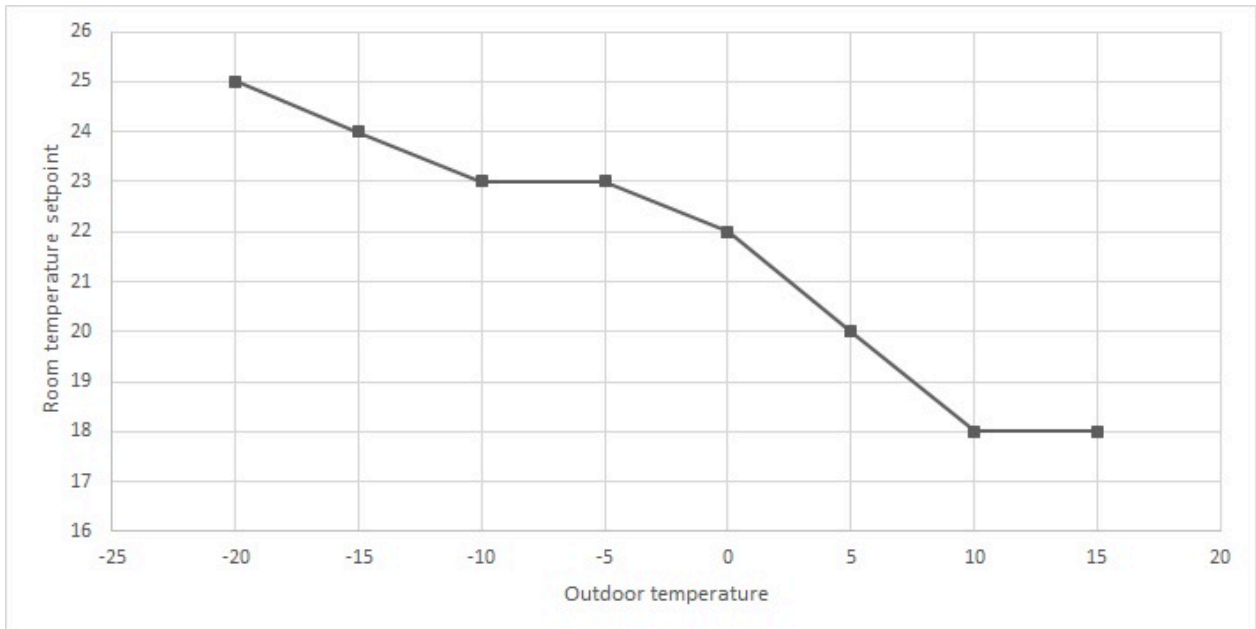

Figure 4-3 Temperature compensation curve

Table 4-8 Default settings for compensation curve

Outdoor temperature (°C)	Setpoint supply temperature
-20	25
-15	24
-10	23
-5	23
0	22
5	20
10	18
15	18

Settings and configuration for Room outdoor compensated control

Table 4-9 Path to configuration and settings for Room outdoor compensated

Feature	Menu path in Application tool	Variable	Note
Room outdoor compensated	Configuration ► Functions ► Function activation	Temperature control type	Selection of temperature control
Sequence configuration	Configuration ► Functions ► Sequence A to J		
Starting order heating/cooling	Configuration ► Functions ► Starting order heating and Starting order cooling		

Table 4-9 Path to configuration and settings for Room outdoor compensated (continued)

Feature	Menu path in Application tool	Variable	Note
Add room temperature sensor	Configuration ► Functions ► Temperature control	Room temperature sensor	0...16
Configure input	Configuration ► Analog inputs ► Outdoor temperature		
Setting of P-band and I-time	Ventilation ► PID controllers ► Room		
Setpoint adjustment	Ventilation ► Actual / Setpoint ► Room controller	Setpoint adjustment	
Setpoint outdoor curve (X, Y)	Ventilation ► Actual / Setpoint ► Room controller	✓ Setpoint outdoor curve X (1...4) ✓ Setpoint outdoor curve Y (1...4)	

Required inputs for Room outdoor compensated

Inputs	Menu path in Application tool	Name	Settings
AI	Configuration ► Analog inputs	✓ Outdoor temperature ✓ Room temperature 1...16 ✓ Supply air temperature	✓ Terminal ✓ Name ✓ Sensor type ✓ Filter factor ✓ Compensation (°C) ✓ Mode ✓ Manual (°C)

Extract air outdoor compensated

Cascade control of the extract air temperature and supply air temperature to achieve an outdoor compensated extract air temperature.

The supply air temperature setpoint is temperature compensated using a control curve with 8 node points, see the curve below in *Figure 4-4 Temperature compensation curve*.

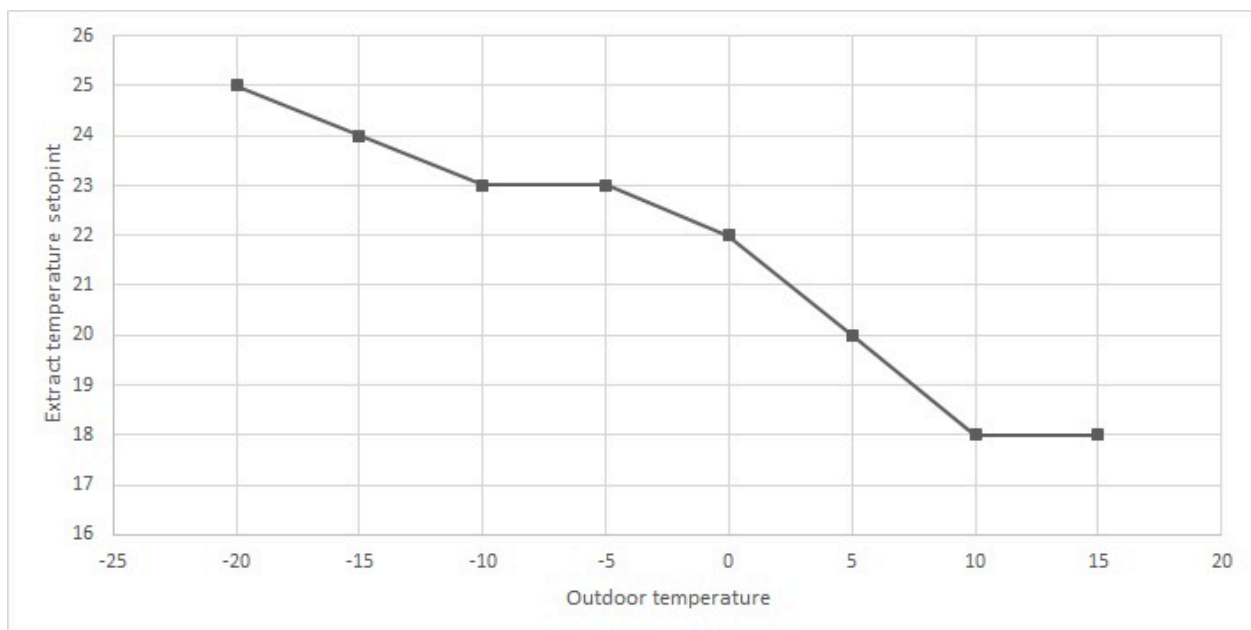

Figure 4-4 Temperature compensation curve

The default settings for the 8 node points are shown in table *Table 4-8 Default settings for compensation curve* below:

Table 4-10 Default settings for compensation curve

Outdoor temperature (°C)	Setpoint supply temperature
-20	25
-15	24
-10	23
-5	23
0	22
5	20
10	18
15	18

Settings and configuration for Extract air outdoor compensated control

Table 4-11 Path to configuration and settings for Extract air outdoor compensated

Feature	Menu path in Application tool	Variable	Note
Extract air outdoor compensated	Configuration ► Functions ► Function activation	Temperature control type	Selection of temperature control
Sequence configuration	Configuration ► Functions ► Sequence A to J		
Starting order heating/cooling	Configuration ► Functions ► Starting order heating and Starting order cooling		
Add extract air temperature sensor	Configuration ► Functions ► Temperature control	Extract air temperature sensor	0...16
Configure input	Configuration ► Analog inputs ► Extract air temperature		
Setpoint outdoor curve (X, Y)	Ventilation ► Actual / Setpoint ► Extract air controller	✓ Setpoint outdoor curve X (1...4) ✓ Setpoint outdoor curve Y (1...4)	
Setting of P-band and I-time	Ventilation ► PID controllers ► Extract air		
Setpoint extract air temperature	Ventilation ► Actual / Setpoint ► Extract air controller	Setpoint extract air	
Setpoint adjustment	Ventilation ► Actual / Setpoint ► Extract air controller	Setpoint adjustment	

Required inputs for Extract air outdoor compensated

Inputs	Menu path in Application tool	Name	Settings
AI	Configuration ► Analog inputs	✓ Extract air temperature ✓ Outdoor temperature ✓ Supply air temperature	✓ Terminal ✓ Name ✓ Sensor type ✓ Filter factor ✓ Compensation (°C) ✓ Mode ✓ Manual (°C)

Extract air dependent supply air

A difference between extract air temperature and supply air temperature can be configured to maintain the supply air temperature setpoint to follow extract air temperature with this difference (+10°C to -10°C).

Supply air temperature setpoint = extract air temperature + difference.

Settings and configuration for Extract air dependent supply air

Table 4-12 Path to configuration and settings for Extract air dependent supply air

Feature	Menu path in Application tool	Variable	Note
Extract air dependent supply air	Configuration ► Functions ► Function activation	Temperature control type	Selection of temperature control
Sequence configuration	Configuration ► Functions ► Sequence A to J		
Starting order heating/cooling	Configuration ► Functions ► Starting order heating and Starting order cooling		
Add extract air / supply air temperature sensor	Configuration ► Functions ► Temperature control	<ul style="list-style-type: none"> ✓ Extract air temperature sensor ✓ Supply air temperature sensor 	0...16
Configure input	Configuration ► Analog input ► Extract air temperature/Supply air temperature		
Setting of P-band and I-time	Ventilation ► PID controllers ► Extract air		
Setpoint extract air temperature	Ventilation ► Actual/Setpoint ► Extract air controller	Setpoint extract air	
Setpoint adjustment	Ventilation ► Actual/Setpoint ► Extract air controller	Setpoint adjustment	
Setpoint temperature difference	Ventilation ► Actual/Setpoint ► Supply air controller	Setpoint delta T extract air - supply air (°C)	

Required inputs for Extract air dependent supply air

Inputs	Menu path in Application tool	Name	Settings
AI	Configuration ► Analog inputs	<ul style="list-style-type: none"> ✓ Extract air temperature ✓ Supply air temperature 	<ul style="list-style-type: none"> ✓ Terminal ✓ Name ✓ Sensor type ✓ Filter factor ✓ Compensation (°C) ✓ Mode ✓ Manual (°C)

4.3 Temperature sequences

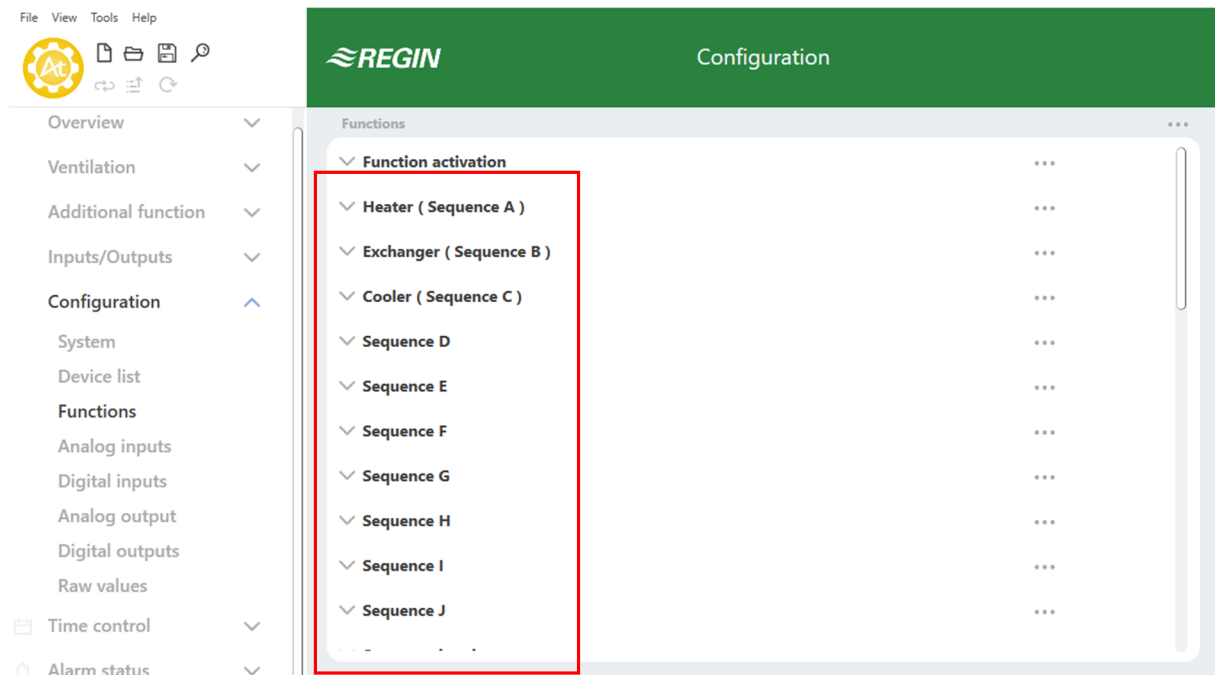

Figure 4-5 Configuration - Functions - Sequences

The supply air controller output is either a heating demand or a cooling demand depending on if the supply temperature is over or under the setpoint. This demand is then divided into up to 10 sequences A to J. Each sequence can be configured as *Heating*, *Cooling*, *Exchanger*, *Damper*, *Fan setpoint compensation* or *Not used*. (See 5.5.2 Sequences for more information about configuration).

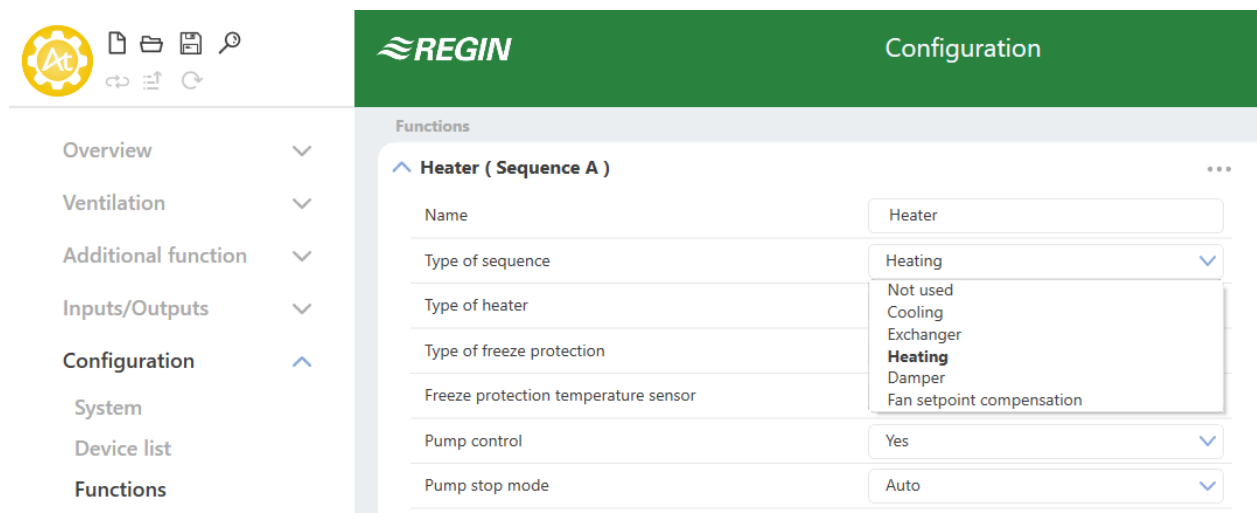

Figure 4-6 Sequence types

Each sequence has its own PID-settings that can be set in the **Ventilation** section of Application tool.

Each of these output sequences can be bound to either an analogue output, to two digital 3-position increase/decrease outputs, to one pulse-width modulated (PWM) digital output with a settable period time, or to a start/stop digital output with configurable start and stop limits.

4.3.1 Heater (Sequence A)

Sequence A is set to *Heater* as default, but can be changed

Heater types

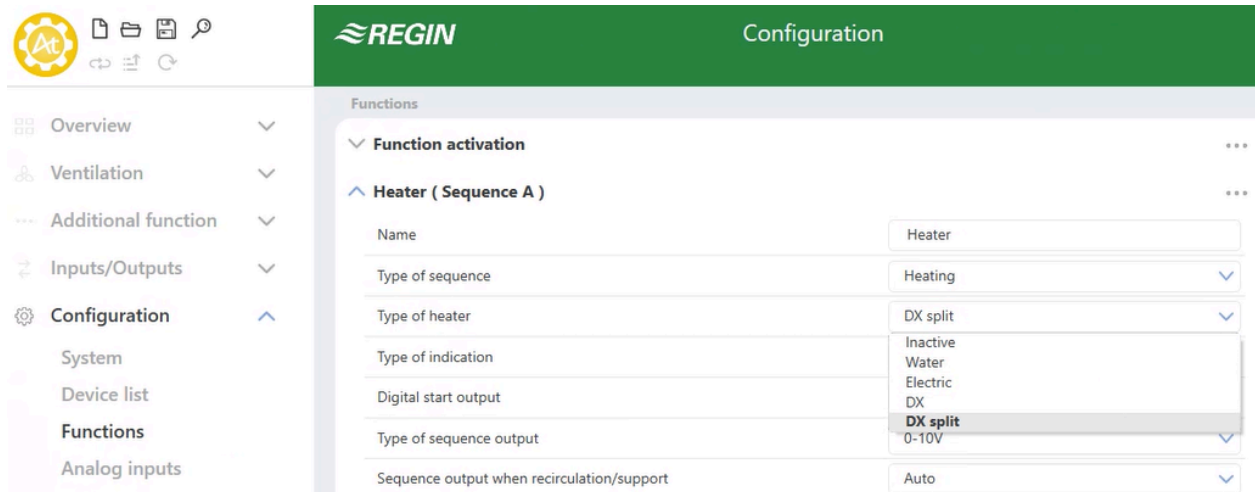

Figure 4-7 Path to selection of heater types

Water heating

Control

If a sequence is configured as water heating, it's possible to select if the sequence should be controlled with freeze protection and which freeze protection sensor (1...3) that should be used. The sequence is controlled by the corresponding sequence analogue output or by two digital outputs: 3-position actuator; increase and decrease.

Table 4-13 Settings and configuration for water heater

Feature	Menu path in Application tool	Variable	Note
Water heater	Configuration ► Functions ► Heater (Sequence A) or other sequence configured as heater	Type of heater	
Freeze protection	Configuration ► Functions ► Heater (Sequence A) or other sequence configured as heater	Type of freeze protection	
Select freeze protection temperature sensor	Configuration ► Functions ► Heater (Sequence A) or other sequence configured as heater	Freeze protection temperature sensor (1, 2 or 3)	
Sequence start order	Configuration ► Functions ► Starting order heating		
Freeze protection temperature	Configuration ► Analog inputs ► Freeze protection temperature 1...3	<ul style="list-style-type: none"> ✓ Sensor type ✓ Filter factor ✓ Compensation ✓ Mode ✓ Manual ✓ Actual value 	

Table 4-13 Settings and configuration for water heater (continued)

Feature	Menu path in Application tool	Variable	Note
Analogue output	Configuration ► Analog output ► Heater (Sequence A) or other sequence configured as heater	Range output: ✓ 0...10 V ✓ 2...10 V ✓ 10...2 V ✓ 10...0 V	
Digital outputs	Configuration ► Digital outputs ► Sequence A increase / Sequence A decrease	✓ NC (Normally closed) ✓ NO (Normally open)	

Table 4-14 Required outputs for water heater

Outputs	Menu path in Application tool	Name	Settings
AO	Configuration ► Analog output	Heater (Sequence A) or other sequence configured as heater	Range output: ✓ 0...10 V ✓ 2...10 V ✓ 10...2 V ✓ 10...0 V
DO	Configuration ► Digital outputs	Sequence A increase/Sequence A decrease	✓ NC (Normally closed) ✓ NO (Normally open)

Freeze protection

The heater return water temperature is measured using the analog input *Freeze protection temperature 1...3* or the digital input *Freeze protection guard*, depending on the selection of freeze protection (*Configuration ► Heater (Sequence A) ► Type of freeze protection*). Low temperatures will generate an internal, proportional signal that is used to force the heating valve open, thereby preventing freeze-up of the heater.

The internal signal will begin to rise as the frost protection temperature falls below the *Alarm limitation running mode + P-band running mode* in order to reach 100 % output when the signal has fallen to *Alarm level*.

When the internal signal reaches 100 % or the digital input *Freeze protection guard* is activated, the unit is shut down, the heating output is set to completely open mode and an alarm is activated. .



Note! The unit is restarted when the alarm has been acknowledged and the temperature for the frost protection sensor has risen above *Alarm limitation running mode + P-band running mode*.

Freeze protection control is available on all sequences A to J.

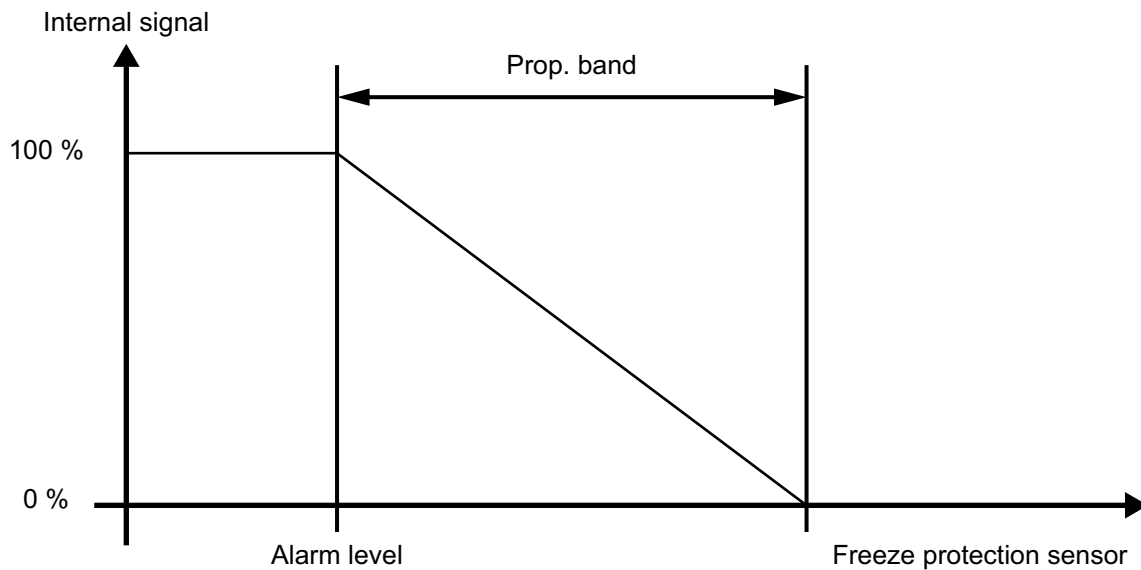

Figure 4-8 Freeze protection

Table 4-15 Settings and configuration for freeze protection

Feature	Menu path in Application tool	Variable	Note
Water heater	Configuration ► Functions ► Heater (Sequence A) (or other sequence configured as heater)	Type of heater	<ul style="list-style-type: none"> ✓ Inactive ✓ Water ✓ Electric ✓ DX ✓ DX split
Freeze protection	Configuration ► Functions ► Heater (Sequence A) (or other sequence configured as heater)	Type of freeze protection	<ul style="list-style-type: none"> ✓ Temperature sensor ✓ Freeze guard ✓ Sensor + Guard
Freeze protection temperature sensor	Configuration ► Functions ► Heater (Sequence A) (or other sequence configured as heater)	1...3	
Configuration of freeze protection temperature,	Configuration ► Analog inputs ► Freeze protection temperature 1...3	<ul style="list-style-type: none"> ✓ Sensor type ✓ Filter factor ✓ Compensation ✓ Mode ✓ Manual ✓ Actual value (read only) 	
Freeze protection setpoints	Ventilation ► Temperature control ► Freeze protection 1...3	<ul style="list-style-type: none"> ✓ Alarm limitation running mode ✓ P-band running mode ✓ Setpoint standby mode 	
PID-settings	Ventilation ► PID-controllers ► Freeze protection 1...3		

Table 4-16 Required inputs for freeze protection

Inputs	Menu path in Application tool	Name	Settings
AI	Configuration ► Analog inputs	Freeze protection temperature 1...3	<ul style="list-style-type: none"> ✓ Sensor type ✓ Filter factor ✓ Compensation ✓ Mode ✓ Manual ✓ Actual value (read only)



Note! Freeze protection can also be created using the digital input *Freeze protection guard* and an external thermostat. Activation of the input will force the running mode to **Off** and an alarm will be activated. The heating sequence output is set to completely open, the remaining control outputs are set to zero.

Standby mode

If frost protection is activated the controller will go into *Standby mode* when the running mode switches to **Off**. The controller will then control the heating output to maintain a constant temperature at the frost protection sensor. The setpoint for the standby mode is found in *Ventilation ▶ Temperature control ▶ Freeze protection 1...3*

Electric heating

Electric heating is controlled using the analogue output sequence A to J. On activation of the digital input *Overheated electric heater* the unit will be shut down, either according to the stop sequence described in section 5.13 *Starting and stopping the Corrigo* or as an emergency shutdown. The unit will restart after the alarm has been acknowledged and *Overheated electric heater* has reset. Note that activation of the input signal *Flow guard* will also stop the unit.

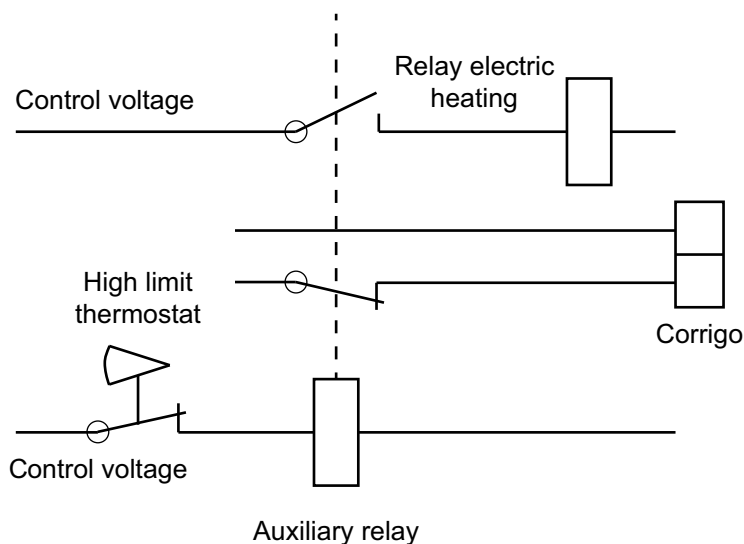

Figure 4-9 Wiring example, high temp limit. Contactors are drawn inactivated.



Note! It is important that the high temperature thermostat is hardwired to disconnect the power to the heater to ensure that the heating is shut down when the thermostat is activated even if the Corrigo should be faulty.

Table 4-17 Settings and configuration for electric heating

Feature	Menu path in Application tool	Variable	Note
Electric heater	Configuration ▶ Functions ▶ Heater (Sequence A) (or other sequence configured as heater)	Type of heater	
Overheating	Configuration ▶ Digital inputs ▶ Overheated electric heater		
Flow guard	Configuration ▶ Digital inputs ▶ Flow guard		
Alarm	Alarm status		

Table 4-18 Required inputs for electric heating

Inputs	Menu path in Application tool	Name	Settings
DI	Configuration ► Digital input	<ul style="list-style-type: none"> ✓ Overheated electric heater ✓ Flow guard 	

Fast stop on overheating

Fast stop is an option in Alarm 63- *Electric heating is overheated*. The function means that the fans will be immediately stopped when there is an overheating alarm, regardless of the set cool-down time. It is set in *Alarm status ► 63 Electric heating is overheated ► Edit ► Alarm action*.

DX heater

A DX heater is used together with DX cooler in case of controlling a reversible heat pump.

The heat pump can be switched between heating and cooling. The type of heater sequence needs to be set to *DX* and the type of cooler sequence to either *DX* or *DX with exchanger control*.

Both sequences are combined with a changeover function.

Inputs and outputs used for controlling the reversible heat pump:

Table 4-19 Required inputs and outputs for controlling the reversible heat pump

Inputs and outputs	Menu path in Application tool	Name	Note
DI	Configuration ► Digital inputs	<ul style="list-style-type: none"> ✓ Feedback cooling sequence ✓ Lock PID controller supply 	
AO	Configuration ► Analog outputs	Changeover 1/2	
DO	Configuration ► Digital outputs	<ul style="list-style-type: none"> ✓ Changeover 1/2 ✓ Cooling sequence 	

DX split heater

A DX split heater is used together with a DX split cooler in case of controlling a DX split unit.

The DX split unit can be switched between heating and cooling. The type of heater sequence needs to be set to *DX split* and the type of cooler sequence needs to be set to *DX split* as well.

The sequences are combined with a changeover function.

Inputs and outputs used for controlling the DX split unit:

Table 4-20 Settings and configuration for DX split

Feature	Menu path in Application tool	Variable	Note
DX split heater	Configuration ► Functions ► Heater (Sequence A) or other sequence configured as heater	Type of heater	

Table 4-21 Required inputs and outputs for DX split heater

Inputs and outputs	Menu path in Application tool	Name	Note
DI	Configuration ► Digital inputs	<ul style="list-style-type: none"> ✓ Cooling/(Heating) change-over 1 ✓ Changeover 1 alarm ✓ Changeover 1 defrost ✓ Changeover 1 run indication 	
AO	Configuration ► Analog outputs	Changeover 1/2	
DO	Configuration ► Digital outputs	<ul style="list-style-type: none"> ✓ Changeover 1/2 start ✓ Changeover 1/2 heat/cool 	

Inputs and outputs for heater types

Water heating	Electric heating	DX heating	
AI			Freeze protection sensor 1...3 (optional)
DI			Freeze protection thermostat 1...3 water heater (optional)
	DI		Overheated electric heater
	DI		Flow switch (optional)
AO	AO	AO	Sequence x
DO	DO	DO	<ul style="list-style-type: none"> ✓ Sequence x start ✓ Sequence x PWM ✓ Sequence x increase ✓ Sequence x decrease ✓ Sequence x pump

4.3.2 Exchanger (Sequence B)

Sequence B is set to *Exchanger* by default but can be changed.

The heat exchanger unit can be set to one of the following alternatives:

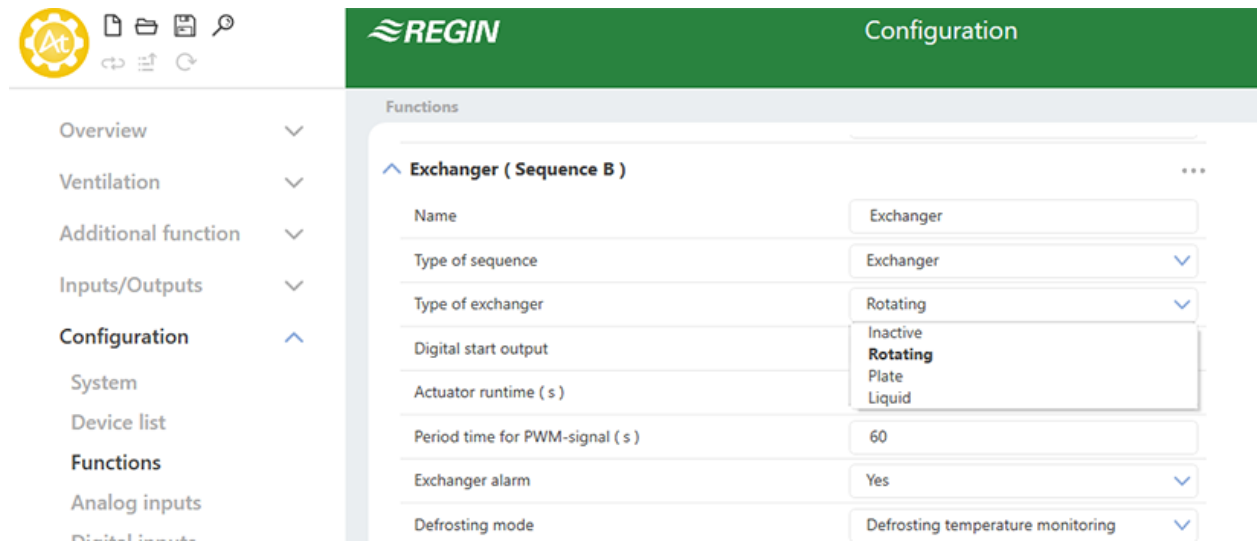

Figure 4-10 Exchanger alternatives

Rotating exchanger

Control

Rotational speed is controlled by the analogue signal Sequence A to J. A rotation guard can be connected to the digital input *Rotary exchanger alarm* (Alarm 67 *Rotary changer alarm* in the Alarm status). An alarm is generated if this input is not activated at the same time as the analogue output signal is higher than 1.0 V.

Freeze protection

A defrosting sensor or an exhaust air temperature sensor can be used as a prevention sensor. It is possible to set a starting temperature in *Ventilation* ▶ *Temperature control* ▶ *Exchanger* ▶ *Defrosting setpoint min limit* and *Min time*. This represents both the minimum time that the function should be active, the supply air fan (SAF) and extract air fan (EAF) compensation, as well as the minimum time before the next prevention cycle should begin. While the cycle is active, **Defrosting mode** is shown in the display.

Outdoor temperature control of exchanger

Instead of using Sequence A to J for analogue control of the heat exchanger it can be set to run on-off against outdoor temperature. The function controls a digital output *Outdoor controlled exchanger*, which is activated when the outdoor temperature falls below a set value.

Settings and configuration for rotating exchanger

Table 4-22 Rotating exchanger, settings and configuration

Feature	Menu path in Application tool	Variable	Note
Rotating exchanger	Configuration ► Functions ► Exchanger (Sequence B) (or other sequence configured as exchanger)	Type of exchanger	
Analog output signal	Configuration ► Analog outputs ► Sequence A to J	Range output: ✓ 0...10 V ✓ 2...10 V ✓ 10...2 V ✓ 10...0 V	
Defrosting	Configuration ► Functions ► Temperature control	Defrosting exchanger	
Defrosting temperature sensor	Configuration ► Functions ► Temperature control	Defrosting temperature sensor	Defrosting sensor Exhaust air temperature
Outdoor control	Configuration ► Digital outputs ► Outdoor controlled exchanger		
Temperature setpoints	Ventilation ► Temperature control ► Exchanger	Outdoor start/stop exchanger temperature Defrosting setpoint min limit Stop supply air fan if outdoor temp <	
Hysteresis setpoints	Ventilation ► Temperature control ► Exchanger	Hysteresis Hysteresis to stop defrosting	
Delay setpoints	Ventilation ► Temperature control ► Exchanger	Start delay exchanger Start delay with 100 % exchanger Start alarm delay	

Plate exchanger

Control

The airflow through the exchanger is controlled by a shut-off damper and a by-pass damper. Both dampers are controlled by the same analogue output Sequence A to J or by two types of digital outputs: Sequence A to J PWM or 3-position actuator; increase and decrease (*Sequence A to J increase/decrease*) and are wired so that one opens as the other closes.

Defrosting

Defrosting is activated either when the digital signal *Defrosting* is activated in Application tool or when the value of the analogue input *Defrosting temperature* falls below the de-icing limit (-3°C), or when the analogue signal *Pressure extract air* rises above the set value for the current pressure.

It is deactivated when the digital signal is reset, or alternatively when the analogue signal rises above the limit value plus a settable differential (*Ventilation ► Temperature control ► Exchanger ► Hysteresis to stop defrosting*). It's also possible to use *Exhaust air temperature* instead of *Defrosting temperature* for the defrosting function (*Configuration ► Functions ► Temperature control ► Defrosting temperature sensor*).

A PI-controller compares the defrosting setpoint with the signal *Defrosting guard exchanger*. The lesser of the output signal from this controller and the output from the ordinary controller is used as output to the bypass dampers.

If the digital input signal *Defrosting guard exchanger* is activated the exchanger is blocked, it will stay blocked as long as the digital input signal is active.

Freeze protection

A defrosting sensor or an exhaust air temperature sensor can be used as a prevention sensor. It is possible to set a starting temperature in *Ventilation ▶ Temperature control ▶ Exchanger ▶ Defrosting setpoint min limit* and *Min time*. This represents both the minimum time that the function should be active, the supply air fan (SAF) and extract air fan (EAF) compensation, as well as the minimum time before the next prevention cycle should begin. While the cycle is active, **Defrosting mode** is shown in the display.

Table 4-23 Configuration and settings for Plate exchanger

Feature	Menu path in Application tool	Variable	Note
Plate exchanger	Configuration ▶ Functions ▶ Sequence B (exchanger) or other sequence configured as exchanger	Type of exchanger	
Damper control, Analog Output	Configuration ▶ Analog output ▶ Sequence B (exchanger) or other sequence configured as exchanger	Range output: ✓ 0...10 V ✓ 2...10 V ✓ 10...2 V ✓ 10...0 V	
3-position increase / decrease outputs	Configuration ▶ Digital outputs ▶ Sequence A to J increase / decrease	✓ NC (Normally closed) ✓ NO (Normally open)	
PWM with settable period time	Configuration ▶ Digital outputs ▶ Sequence A to J PWM	✓ NC (Normally closed) ✓ NO (Normally open)	
PWM period time	Configuration ▶ Functions ▶ Sequence A to J	Period time for PWM signal	
Defrosting	Configuration ▶ Functions ▶ Exchanger (Sequence B or other sequence configured as exchanger)	Defrosting mode	
Defrosting sensor	Configuration ▶ Functions ▶ Temperature control	Defrosting temperature sensor	
Defrosting exchanger	Configuration ▶ Functions ▶ Temperature control	Defrosting exchanger	Yes / No
Defrosting temperature	Configuration ▶ Analog inputs ▶ Defrosting temperature	✓ Sensor type ✓ Filter factor ✓ Compensation (°C) ✓ Mode ✓ Manual (°C) ✓ Actual value (°C)	
Extract air fan speed when defrosting	Configuration ▶ Functions ▶ Temperature control	Extract air fan speed when defrosting with stopped supply air	✓ Auto ✓ Low ✓ Normal ✓ High
Pressure extract air	Configuration ▶ Analog inputs ▶ Pressure extract air		
Exhaust air temperature	Configuration ▶ Analog inputs ▶ Exhaust air temperature	✓ Sensor type ✓ Filter factor ✓ Compensation (°C) ✓ Mode ✓ Manual (°C) ✓ Actual value (°C)	
Temperature setpoints	Ventilation ▶ Temperature control ▶ Exchanger	✓ Outdoor start / stop exchanger temperature (°C) ✓ Defrosting setpoint limit (°C) ✓ Stop supply air time if outdoor temp < (°C)	

Table 4-23 Configuration and settings for Plate exchanger (continued)

Feature	Menu path in Application tool	Variable	Note
Hysteresis setpoints	Ventilation ► Temperature control ► Exchanger	<ul style="list-style-type: none"> ✓ Hysteresis (°C) ✓ Hysteresis to stop defrosting (°C) 	
Delay setpoints	Ventilation ► Temperature control ► Exchanger	<ul style="list-style-type: none"> ✓ Start delay exchanger (s) ✓ Start delay with 100 % exchanger (s) ✓ Start alarm delay (s) 	

Liquid exchanger

Control

A mixing valve in the exchanger circulation system is controlled by the analog signal sequence A to J or by two types of digital outputs: Sequence A to J PWM or 3-position actuator; increase and decrease (*Sequence A to J increase/decrease*).

The circulation pump is started as soon as the actuator control signal exceeds 0.1 V and is stopped when the valve has been closed for more than 5 minutes. (*Ventilation ► Temperature control ► Sequence X ► Pump stop delay*)

Defrosting

Defrosting is activated either when the digital input signal *Defrosting guard exchanger* is activated or when the value of the analog input *Defrosting temperature* falls below the deicing limit (-3°C). It is deactivated when the digital input is reset, or the analog input rises above the limit value plus a settable differential. (*Ventilation ► Temperature control ► Exchanger ► Hysteresis to stop defrosting*)

On defrosting:

A PI-controller compares the defrosting setpoint with the signal from the *Defrosting temperature sensor* or *Exhaust air temperature sensor* (*Configuration ► Functions ► Temperature control*). The lesser of the output signal from this controller and the output from the ordinary controller is used as output to the actuator.

If the digital input signal *Defrosting guard exchanger* is activated the exchanger is blocked, it will stay blocked as long as the digital input signal is active.

Function to prevent the heat exchanger from freezing:

A defrosting sensor or an exhaust air temperature sensor can be used as a prevention sensor. It is possible to set a starting temperature in *Ventilation ► Temperature control ► Exchanger ► Defrosting setpoint min limit* and *Min time*. This represents both the minimum time that the function should be active, the supply air fan (SAF) and extract air fan (EAF) compensation, as well as the minimum time before the next prevention cycle should begin. While the cycle is active, **Defrosting mode** is shown in the display.

Outdoor temperature control of exchanger

Instead of using Sequence A to J for analogue control of the heat exchanger it can be set to run on-off against outdoor temperature. This function is activated when you configure the digital output *Outdoor controlled exchanger*. The digital output is available if the *Outdoor temperature sensor* in *Configuration ► Functions ► Temperature control* is set to anything else than **No**.

The digital output is activated when the outdoor temperature falls below a set value. The temperature setpoint is set in the Analog input *Outdoor temperature* or *Intake air temperature*, depending on the configuration.

Configuration and settings for Liquid exchanger

Table 4-24 Configuration and settings for Liquid exchanger

Feature	Menu path in Application tool	Variable	Note
Liquid exchanger	Configuration ► Functions ► Sequence B (exchanger) or other sequence configured as exchanger	Type of exchanger	
Damper control, Analog Output	Configuration ► Analog output ► Sequence B (exchanger) or other sequence configured as exchanger	Range output: ✓ 0...10 V ✓ 2...10 V ✓ 10...2 V ✓ 10...0 V	
3-position increase / decrease outputs	Configuration ► Digital outputs ► Sequence A to J increase / decrease	✓ NC (Normally closed) ✓ NO (Normally open)	
PWM with settable period time	Configuration ► Digital outputs ► Sequence A to J PWM	✓ NC (Normally closed) ✓ NO (Normally open)	
PWM period time	Configuration ► Functions ► Sequence A to J	Period time for PWM signal	
Defrosting	Configuration ► Functions ► Sequence B (exchanger) or other sequence configured as exchanger	Defrosting mode	
Defrosting sensor	Configuration ► Functions ► Temperature control	Defrosting temperature sensor	
Defrosting exchanger	Configuration ► Functions ► Temperature control	Defrosting exchanger	Yes / No
Defrosting temperature	Configuration ► Analog inputs ► Defrosting temperature	✓ Sensor type ✓ Filter factor ✓ Compensation (°C) ✓ Mode ✓ Manual (°C) ✓ Actual value (°C)	
Extract air fan speed when defrosting	Configuration ► Functions ► Temperature control	Extract air fan speed when defrosting with stopped supply air	✓ Auto ✓ Low ✓ Normal ✓ High
Outdoor controlled exchanger	Configuration ► Digital outputs ► Outdoor controlled exchanger	✓ NC (Normally closed) ✓ NO (Normally open)	
Exhaust air temperature	Configuration ► Analog inputs ► Exhaust air temperature	✓ Sensor type ✓ Filter factor ✓ Compensation (°C) ✓ Mode ✓ Manual (°C) ✓ Actual value (°C)	
Temperature setpoints	Ventilation ► Temperature control ► Exchanger	✓ Outdoor start / stop exchanger temperature (°C) ✓ Defrosting setpoint limit (°C) ✓ Stop supply air fan if outdoor temp < (°C)	
Hysteresis setpoints	Ventilation ► Temperature control ► Exchanger	✓ Hysteresis (°C) ✓ Hysteresis to stop defrosting (°C)	
Delay setpoints	Ventilation ► Temperature control ► Exchanger	✓ Start delay exchanger (s) ✓ Start delay with 100 % exchanger (s) ✓ Start alarm delay (s)	

Exchanger and damper sequence

If both an exchanger sequence and a damper sequence is configured, the exchanger sequence will stop when the damper sequence reaches 100 %.

Inputs and outputs for exchanger types

Rotating	Plate	Liquid	Description
AI	AI	AI	Defrosting temperature
DI	DI	DI	Feedback sequence x
	DI	DI	Defrosting guard exchanger
DI			Rotary exchanger alarm
AO ¹	AO ¹	AO ¹	Sequence x analog output
DO ¹	DO ¹	DO ¹	<ul style="list-style-type: none"> ✓ Sequence x PWM ✓ Sequence x increase/ decrease ✓ Sequence x start
		DO ¹	Sequence x pump

1. Depending on type of sequence output

4.3.3 Cooler (Sequence C)

Sequence C is set to Cooling as default, but it can be changed to any sequence.

Water cooling

Control

If a sequence is configured as water cooling, it's controlled by the corresponding sequence analog output or by two digital outputs; 3-position actuator; increase and decrease.

Table 4-25 Settings and configuration for water cooling

Feature	Menu path in Application tool	Variable	Description
Water cooling	Configuration ► Functions ► Cooler (Sequence C) or other sequence configured as cooler	Type of cooler	
Analogue output	Configuration ► Analog outputs ► Cooler (Sequence C) or other sequence configured as cooler	Range output: ✓ 0...10 V ✓ 2...10 V ✓ 10...2 V ✓ 10...0 V	
Digital output	Configuration ► Digital outputs ► Sequence C increase / decrease	✓ NC (Normally closed) ✓ NO (Normally open)	
PID settings	Ventilation ► PID controllers ► Cooler (sequence C)		
Sequence start order	Configuration ► Functions ► Sequence cooling		

DX cooling with room or extract air control

If DX cooling is used in conjunction with room temperature control or extract air temperature control, there are two configuration alternatives, DX cooling or DX cooling with exchanger control.

DX cooling

When running cascade control, the supply air controller setpoint is normally controlled by the room/extract air controller output signal.

When DX cooling is activated, the supply air controller setpoint is lowered to five degrees (adjustable) below the setpoint given by the room/extract air controller. This prevents the DX cooling from being activated/deactivated too often.

Table 4-26 Settings and configuration for DX cooling

Feature	Menu path in Application tool	Variable	Note
DX cooling	Configuration ► Functions ► Cooler (Sequence C) or other sequence configured as cooler	Type of cooler	
Supply air controller setpoint for DX	Ventilation ► Actual / Setpoint ► Supply air controller	Reduction of min limit supply air if active DX-cooling (°C)	
Setpoint Room / Extract air	Ventilation ► Actual / Setpoint ► Room controller/ Extract air controller	<ul style="list-style-type: none"> ✓ Setpoint adjustment ✓ Setpoint room / extract air ✓ Actual setpoint ✓ Controller output 	

DX cooling with exchanger control

When running cascade control, the supply air controller setpoint is normally controlled by the room/extract air controller output signal.

When DX cooling is activated, the supply air controller setpoint is lowered to five degrees (adjustable) below the setpoint given by the room/extract air controller. This prevents the DX cooling from being activated/deactivated too often.

If the supply air temperature falls below the setpoint given by the room/extract air controller, the heat exchanger output will be activated in order to try to maintain the supply air setpoint given by the room/extract air controller. The output uses P-control with a P-band of half the setpoint lowering (adjustable, 2.5° C as default). The setpoint given by the room/extract air controller cannot drop below the set min limit. When there is no longer a cooling demand, the supply air controller setpoint will return to the value given by the room/extract air controller.



Note! The function cannot be used if the exchanger signal controls a mixing damper.

Example:

The room controller gives a supply air setpoint of 16°C. If there is a cooling demand, the supply air controller setpoint is lowered to 11°C (16 – 5) and DX cooling is activated. Should the supply air temperature fall below 16°C, the exchanger output will be activated and reach 100 % output when the supply air temperature has fallen to 13.5°C (16 - 2.5).

Table 4-27 Settings and configuration for DX cooling with exchanger control

Feature	Menu path in Application tool	Variable	Note
DX cooling	Configuration ► Functions ► Cooler (Sequence C) or other sequence configured as cooler	Type of cooler	
Supply air controller setpoint for DX	Ventilation ► Actual / Setpoint ► Supply air controller	Reduction of min limit supply air if active DX-cooling (°C)	

Table 4-27 Settings and configuration for DX cooling with exchanger control (continued)

Feature	Menu path in Application tool	Variable	Note
Setpoint Room / Extract air	Ventilation ► Actual / Setpoint ► Room controller/ Extract air controller	<ul style="list-style-type: none"> ✓ Setpoint adjustment ✓ Setpoint room / extract air ✓ Actual setpoint ✓ Controller output 	
Heat exchanger output	Configuration ► Analog outputs ► Exchanger (Sequence B)	Range output: <ul style="list-style-type: none"> ✓ 0...10 V ✓ 2...10 V ✓ 10...2 V ✓ 10...0 V 	
P-band	Ventilation ► PID controllers ► Exchanger (Sequence B) / Cooler (Sequence C)		

DX split cooling

If DX split cooling is used in conjunction with room temperature control, you need to use the configuration alternative DX split.

When running cascade control, the supply air controller setpoint is normally controlled by the room/extract air controller output signal. When DX split cooling is activated, you need to set a neutral zone around the setpoint given by the room/extract air controller. This prevents the DX split cooling from being activated/deactivated too often.



Note! Using the DX split function for cooling requires that DX split is used for heating. One will not work without the other.

Example:

The room controller gives a supply air setpoint of 16°C. If there is a cooling demand, the supply air controller setpoint is lowered to 11°C (16 - 5) and DX split cooling is activated. Should the supply air temperature fall below 16°C, the exchanger output will be activated and reach 100% output when the supply air temperature has fallen to 13.5°C (16 - 2.5).

Table 4-28 Settings and configuration for DX split

Feature	Menu path in Application tool	Variable	Note
DX split cooling	Configuration ► Functions ► Cooler (Sequence C) or other sequence configured as cooler	Type of cooler	

Table 4-29 Required inputs and outputs for DX split cooler

Inputs and outputs	Menu path in Application tool	Name	Note
DI	Configuration ► Digital inputs	<ul style="list-style-type: none"> ✓ Cooling/(Heating) change-over 1 ✓ Changeover 1 alarm ✓ Changeover 1 defrost ✓ Changeover 1 run indication 	
AO	Configuration ► Analog outputs	Changeover 1/2	
DO	Configuration ► Digital outputs	<ul style="list-style-type: none"> ✓ Changeover 1/2 start ✓ Changeover 1/2 heat/cool 	

Blocking of DX cooling at low outdoor temperature

DX cooling can be blocked when the outdoor temperature is low. It is possible to block the four cooling steps individually or to block all DX cooling. The temperature limits are adjustable (+13°C default) and have a fixed one degree hysteresis.

When two DX cooling steps are used with binary function, the cooling effect is divided into three steps. The desired blocking level can be set individually for each of these steps.

When three DX cooling steps are used with binary function, the cooling effect is divided into seven steps. However, the controller still only has four blocking level settings. Therefore, *Blocking step 1* will apply to binary steps 1 and 2, *Blocking step 2* to binary steps 3 and 4, *Blocking step 3* to binary steps 5, 6 and *Blocking step 4* to binary steps 7.

When four DX cooling steps are used with binary function, the cooling effect is divided into fifteen steps. However, the controller still only has four blocking level settings. Therefore, *Blocking step 1* will apply to binary steps 1-4, *Blocking step 2* to binary steps 5-8, *Blocking step 3* to binary steps 9-12 and *Blocking step 4* to binary steps 13-15.

Table 4-30 Settings and configuration for blocking DX cooling at low outdoor temperature

Feature	Menu path in Application tool	Variable	Note
Block DX cooling	Ventilation ► Temperature control ► Step Controller 1/2	Block step x if outdoor temperature < (°C)	
Hysteresis	Ventilation ► Temperature control ► Step Controller 1/2	Block DX-cooling if outdoor temperature < (°C)	

Blocking of DX cooling at low supply air fan speed

When DX cooling is used in conjunction with pressure controlled or flow controlled fans it is possible to block DX cooling if the supply air fan control signal falls below a preset values. For sequential control, the blocking level is individually settable for each DX cooling step.

When two DX cooling steps are used with binary function, the cooling effect is divided into three steps. The desired blocking level can be set individually for each of these steps.

When three DX cooling steps are used with binary function, the cooling effect is divided into seven steps. However, the controller still only has four blocking level settings. Therefore, *Blocking step 1* will apply to binary steps 1 and 2, *Blocking step 2* to binary steps 3 and 4, *Blocking step 3* to binary steps 5, 6 and *Blocking step 4* to binary steps 7.

When four DX cooling steps are used with binary function, the cooling effect is divided into fifteen steps. However, the controller still only has four blocking level settings. Therefore, *Blocking step 1* will apply to binary steps 1-4, *Blocking step 2* to binary steps 5-8, *Blocking step 3* to binary steps 9-12 and *Blocking step 4* to binary steps 13-15.

Table 4-31 Settings and configuration for blocking DX cooling at low supply air fan speed

Feature	Menu path in Application tool	Variable	Note
Block DX cooling	Ventilation ► Temperature control ► Step Controller 1/2	Block step x if supply air fan output signal < (%)	

Blocking of DX cooling on cooling pump alarm

Corrigo can be configured to block DX cooling on cooling pump alarm. The setting is found in *Configuration ► Functions ► Step controller 1/2 ► Block output if sequence feedback alarm*.

Inputs and outputs, Cooling and Heating / Cooling Changeover

Table 4-32 Inputs and outputs

Water	DX	DX with exchanger control	Description
DI	DI	DI	Feedback sequence x
AO ¹	AO ¹	AO ¹	Sequence x analog output
DO ¹	DO ¹	DO ¹	<ul style="list-style-type: none"> ✓ Sequence x PWM ✓ Sequence x increase/decrease ✓ Sequence x start
DO ¹			Sequence x pump

1. Depending on type of sequence output

4.3.4 Damper sequence

Mixing dampers

Control

The analog output signal sequence A to J, or the digital output signals Sequence A to J PWM or 3-position; increase and decrease (*Sequence A to J increase/decrease*), control two dampers for gradual mixing of outdoor air and recirculated air.

Table 4-33 Settings and configuration for Mixing dampers

Feature	Menu path in Application tool	Variable	Description
Select damper control	Configuration ► Functions ► Any sequence	Type of sequence	
Analog output	Configuration ► Analog outputs ► Selected sequence		
Digital output, PWM	Configuration ► Digital outputs ► Selected sequence	Sequence x PWM	
Digital output, 3 position actuator	Configuration ► Digital outputs ► Selected sequence	<ul style="list-style-type: none"> ✓ Sequence x increase ✓ Sequence x decrease 	

CO₂

If demand controlled ventilation is activated in combination with mixing dampers, CO₂-control is activated for the sequence, and the CO₂-value rises above the setpoint value, the dampers will let in more outdoor air. The function is controlled by a PI-controller.

Table 4-34 Settings and configuration for CO₂ and mixing dampers

Feature	Menu path in Application tool	Variable	Note
Select damper control	Configuration ► Functions ► Any sequence	Type of sequence	
CO ₂ control activation	Configuration ► Functions ► Function activation	CO ₂ control	<ul style="list-style-type: none"> ✓ No ✓ Fan start / stop function ✓ Mixing damper function ✓ Fan start / stop + Mixing damper

Table 4-34 Settings and configuration for CO₂ and mixing dampers (continued)

Feature	Menu path in Application tool	Variable	Note
CO ₂ setpoint	Ventilation ► Demand control ► CO ₂	<ul style="list-style-type: none"> ✓ Setpoint mixing damper (ppm) ✓ Start limit fan start / stop (ppm) ✓ Stop hysteresis fan start / stop (ppm) ✓ Demand control ✓ Min time for CO₂ control (min) 	
PI settings	Ventilation ► PID controllers ► CO ₂		

Minimum limit

An outdoor air minimum limit for the amount of fresh air can be set in Application tool or in the web interface. The limit value is settable between 0 and 100 %. (Application tool ► Configuration ► Functions ► Sequence x ► Sequence output min limit (%) and Sequence output max limit (%))

Damper control and exchanger sequence

If both an exchanger sequence and a damper sequence is configured, the exchanger sequence will stop when the damper sequence reaches 100 %.

Inputs and outputs, Damper

Table 4-35 Inputs and outputs Dampers

Dampers	
AI ¹	<ul style="list-style-type: none"> ✓ Humidity room/extract ✓ Humidity outdoor ✓ CO₂ room/extract
DI	Feedback sequence x
AO ²	Sequence x analog output
DO ²	<ul style="list-style-type: none"> ✓ Sequence x PWM ✓ Sequence x increase/decrease ✓ Sequence x start

1. Depending on control mode

2. Depending on type of sequence output

Damper via Modbus

There is support for the following damper via Modbus communication:

- ✓ Regin
- ✓ Belimo
- ✓ Siemens

4.3.5 Sequence Fan setpoint compensation

The fan setpoint compensation is used to integrate the fans into the temperature control sequence for heating or cooling. The speed of the fans can be increased or decreased depending on the signal of the temperature control loop. (Application tool ► Configuration ► Functions ► Sequence x ► Type of setpoint compensation). The output signal of the sequence acts directly on the calculated setpoint of the fans but can

also be output additionally via configured outputs. The maximum compensation is adjustable via a parameter (*Ventilation ▶ Temperature control ▶ Selected sequence ▶ Max fan compensation (%)*).

Table 4-36 Settings and configuration for fan setpoint compensation

Feature	Menu path in Application tool	Variable	Note
Select fan setpoint compensation	Configuration ▶ Functions ▶ Sequence x	Type of sequence	
Type of compensation	Configuration ▶ Functions ▶ Selected sequence	Type of setpoint compensation	✓ Decrease ✓ Increase
Max compensation	Ventilation ▶ Temperature control ▶ Selected sequence	Max fan compensation (%)	

Fan setpoint compensation	
DI	Feedback sequence x
AO ¹	Sequence x analog output
DO ¹	<ul style="list-style-type: none"> ✓ Sequence x PWM ✓ Sequence x increase/decrease ✓ Sequence x start

1. Depending on type of sequence output

4.3.6 Changeover

Changeover is a function for installations with 2-pipe systems. It makes it possible to use the same pipe for both heating and cooling, depending on whether heating or cooling is required.

Changeover functions can be used for control of reversible heat pumps, DX split units or external changeover coils.

There are two different changeover functions with two different analog output signals *Changeover 1* and *Changeover 2*, that is used for changeover control.

Switching between heating and cooling can be done in two ways. Open contact gives heating control and closed contact gives cooling control.

If the input has not been configured, changeover is handled by the internal controller signal. The output signal will follow the two sequence output signals *Changeover sequence for heating* and *Changeover sequence for cooling*.

If frost protection sensor has been configured, it will function in the usual way when heating is active. However, when cooling is active, it will only be used for indicating temperature.

To use changeover with DX split, you need to use DX split for both the heating sequence and the cooling sequence. Also note that, unless you assign a setpoint and a neutral zone, the DX split unit will continuously compensate to maintain the set temperature.

Table 4-37 Path to configuration and settings for Changeover

Feature	Menu path in Application tool	Variable	Note
Select changeover sequence	Configuration ▶ Functions ▶ changeover 1/2		
Digital inputs Changeover	Configuration ▶ Digital inputs ▶ Cooling / (Heating) changeover...	<ul style="list-style-type: none"> ✓ NC (Normally closed) ✓ NO (Normally open) ✓ Manual / Auto ✓ Actual value 	

4.3.7 Step controller

Step controller heating / cooling

As an alternative or complement to analog control, heating and cooling can be activated in steps. The internal signal is then used to activate digital outputs for control of the heaters/coolers. Two step controllers with up to four step outputs can be configured in Application tool. There are two possible modes; *Sequential control* and *Binary control*.

Sequential control

Each output step has individually settable on and off values in percent of the control signal. The number of steps is equal to the number of heater/cooler groups. Minimum on and off times can be set, i.e. the minimum time the step has to be inactive or active for a change to occur. An analog output signal can also be used to fill out between the steps. The signal will go 0...100 % between the activation of each step

Binary control

The heater power outputs should be binary weighted (1:2:4:8 same for heating and cooling). The number of steps to be controlled is set in *Configuration ▶ Functions ▶ Step controller 1/2 ▶ Number of steps*. After that, the program will automatically calculate the individual activation levels. Switching differential and minimum on/off times can be set in *Ventilation ▶ Temperature control ▶ Step controller 1/2 ▶ Min switch time, Step x start point, Step x stop point*. The number of heating/cooling steps will be: $2^{\text{no. of groups}} - 1$. In binary mode, the analog output signal (*Step controller 1 / 2*) may also be used to fill out between the steps. The signal will go 0...100 % between the activation of each step. The load connected to the analog signal should have the same size as the smallest of the binary groups. In the example below there are 4 heater groups (1:1:2:4) and the total number of heating/cooling steps is eight.

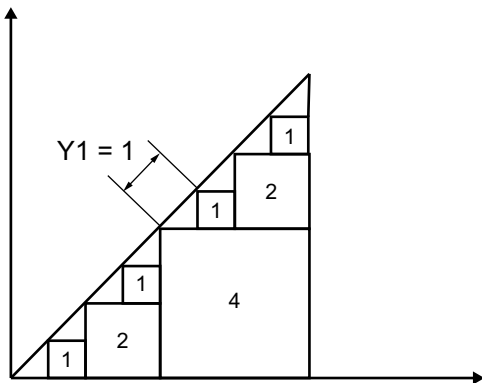

Figure 4-11 Step controller example: 4 heater groups, 8 steps (1:1:2:4)

Table 4-38 Settings and configuration of Step controllers

Feature	Menu path in Application tool	Variable	Description
Select step control	Configuration ▶ Functions ▶ Step controller 1 or 2	<ul style="list-style-type: none"> ✓ Step controller sequence (Sequence A to J or change-over 1 or 2)) ✓ Step control type (Sequential or binary) ✓ Number of steps (1...4) ✓ Block output if sequence feedback alarm (Yes / No) 	
Digital outputs	Configuration ▶ Digital outputs ▶ Step controller 1(2) step 1...4	<ul style="list-style-type: none"> ✓ NC (Normally closed) ✓ NO (Normally open) 	

Table 4-38 Settings and configuration of Step controllers (continued)

Feature	Menu path in Application tool	Variable	Description
Analog output	Configuration ► Analog outputs ► Step controller 1 (2)	Range output: ✓ 0...10 V ✓ 2...10 V ✓ 10...2 V ✓ 10...0 V	
Actual binary step	Ventilation ► Actual / Setpoint ► Step controller 1 or 2		
Min switch time	Ventilation ► Temperature control ► Step controller 1 or 2	Min switch time (s)	
Start / Stop point steps	Ventilation ► Temperature control ► Step controller 1 or 2	Step X start point (%) Step X stop point (%)	
Block DX-cooling	Ventilation ► Temperature control ► Step controller 1 or 2	Block DX-cooling if outdoor temperature < (°C)	
Block step X if supply air fan output signal <	Ventilation ► Temperature control ► Step controller 1 or 2	Block step X if supply air fan output signal < (°C)	
Block step X if outdoor temperature <	Ventilation ► Temperature control ► Step controller 1 or 2	Block step X if outdoor temperature < (°C)	

Step controllers and Changeover

By selecting a sequence that is configured as changeover sequence 1 or 2, the digital output signals step 1...4 will be controlled by both the heating sequence and the cooling sequence that is configured in the changeover function.

4.3.8 Support control

Support control is normally used when room temperature control or extract air control has been configured.

Extract air control

When extract air control is configured a room sensor must be installed. *Support control Heating* or *Support control Cooling* will run if support control is configured, the running mode is in Off-state (timer control **OFF** and not in extended running) and if conditions call for support control (see below). Minimum run time is settable 0 to 720 minutes (FS= 20 minutes) (*Ventilation ► Demand control ► Support control ► Min time for support control*).

Supply air temperature control

Support control can also be configured when supply air temperature control is used, if a room sensor is installed. The controller uses the configured min. (FS=15°C) and max. (FS=30°C) limitation values as support control setpoints (*Ventilation ► Demand control ► Support control*). The values can be changed in *Ventilation ► Actual/Setpoint ► Supply air controller ► Min limit supply air, Max limit supply air*.

Start with supply air fan

Support control can also be configured to start only with the supply air fan. In this mode, the extract air fan is not active. This requires a digital output to be configured, which controls the recirculation damper to open completely so the supply air fan can circulate the air to and from the room. The digital output is called *Recirculation air damper* (*Configuration ► Digital Outputs*).

Active support control for sequence

It's also possible to configure the output value when support control is active (same settings as for recirculation) for each sequence. The sequence output can be configured to 0%, 100% or Auto (modulating 0-100%).

Table 4-39 Settings and configuration for Support control

Feature	Menu path in Application tool	Variable	Description
Select support control	Configuration ► Functions ► Function activation	Support control (Yes/No)	
Extract fan running during support control	Configuration ► Functions ► Support control	Extract fan running during support control (Yes/No)	
Minimum time for support control	Ventilation ► Demand control ► Support control	Min time for support control (min)	
Setpoints to start/stop heating room	Ventilation ► Demand control ► Support control	<ul style="list-style-type: none"> ✓ Start heating room temperature (°C) ✓ Stop heating room temperature (°C) 	
Setpoint heating	Ventilation ► Demand control ► Support control	Setpoint heating (°C)	
Setpoints to start/stop cooling room	Ventilation ► Demand control ► Support control	<ul style="list-style-type: none"> ✓ Start cooling room temperature (°C) ✓ Stop cooling room temperature (°C) 	
Setpoint cooling	Ventilation ► Demand control ► Support control	Setpoint cooling (°C)	

Support control heating

Demand for support control heating is when the room temperature is lower than the start value which is settable 0 to 30°C (*Ventilation ► Demand control ► Support control*). The fans will run at the preset speed, the heater and the heat exchanger are controlled by the supply air temperature controller with the configured max limitation for the supply air (FS=30°C) as setpoint and the cooling is shut off (0%). Support control heating stops when the room temperature rises to the stop value and the minimum run time has been exceeded or the running mode changes to **On**.

For each sequence it's also possible to configure the output value when support control heating is active. The sequence output can be configured to 0%, 100% or Auto (modulating 0-100%) (See section 4.3.14 *Recirculation* for more details).

Support control cooling

Demand for support control cooling is when the room temperature is higher than the start value which is settable 20 to 50°C (*Ventilation ► Demand control ► Support control*). The fans will run at the preset speed, the heater and the heat exchanger (cool recovery is active) are shut down (0 %) and the cooling is controlled by the supply air temperature controller with the configured minimum limitation (FS=12°C) as setpoint. Support control cooling stops when the temperature falls below the stop value and the minimum run time has been exceeded or the running mode changes to **On**.

For each sequence It's also possible to configure the output value when support control cooling is active. The sequence output can be configured to 0%, 100% or Auto (modulating 0-100%) (See section 4.3.14 *Recirculation* for more details).

4.3.9 Free cooling

This function is used during the summer to cool the building night-time using cool outdoor air, thereby reducing the need for cooling during the day and saving energy.

Free cooling requires an outdoor sensor or an intake temperature sensor and either a room sensor or an extract air sensor. If both outdoor sensor and intake sensor is configured it uses the outdoor sensor for the function.

Free cooling is only activated when all the start conditions below are fulfilled:

- ✓ Less than four days have passed since the unit was last in running mode.
- ✓ The outdoor temperature during the previous running period exceeded a set limit (22°C).
- ✓ It is between 00:00 and 07:00 in the day (settable).
- ✓ The timer outputs for *Normal speed* , *Extended running*, *Normal* and *External switch* are **Off**.
- ✓ A timer channel will be **On** sometime during the next 24 hours.
- ✓ The outdoor temperature is a settable difference (FS=2°C) lower than the room/extract temperature (*Ventilation* ► *Demand control* ► *Free cooling* ► *Start when extract-outdoor* > (°C)).

If an intake sensor is used and/or an extract air sensor is selected and ALL the start conditions are fulfilled, free cooling is activated and will run for 3 minutes (settable) to ensure that the temperature measurement when using an extract air sensor reflects the corresponding room temperature, and that the intake temperature sensor senses the outdoor temperature even if it is placed in the fresh air inlet duct. If an outdoor sensor and a room sensor is selected, the unit will not start free cooling as long as all the temperatures are not within the start and stop temperature intervals.

After three minutes (settable), the stop conditions will be controlled.

Stop conditions:

- ✓ Outdoor temp above the set max. value (18°C) or below the set min. value (condensation risk, 10°C).
- ✓ The room temp/extract air temp. is below the set stop value (18°C).
- ✓ Difference between extract/room and outdoor temperature rises above the settable difference (FS=2°C) - a hysteresis of 0.5 °C.
- ✓ The timer outputs for *Normal speed*, *Extended running*, *Normal* or *External switch* are **On**.
- ✓ It is past 07:00 in the day.

If any stop condition is fulfilled after three minutes, the unit will stop again. Otherwise, operation will continue until a stop condition is fulfilled.

If the unit is stopped due to outdoor temperature is outside the temperature intervals the unit will start again after 60 min (settable), it will not start again if room/extract air temp has reached below the stop value.

When free cooling is active, the fans run at normal speed or the set value for pressure/flow control. An offset can also be entered for the fan setpoints during free cooling. The digital output *Free cooling indication* is active. All sequence A to J outputs are shut down. After free cooling has been active, the heating output is blocked at start up for 60 minutes (configurable time).

Table 4-40 Settings and configuration for Free cooling

Feature	Menu path in Application tool	Variable	Note
Select free cooling	Configuration ► Functions ► Function activation	Free cooling (Yes/No)	
Select sensors	Configuration ► Functions ► Temperature control		
Pretreatment during free cooling	Configuration ► Functions ► Pretreatment	Pretreatment during free cooling (Yes/No)	
Free cooling indication (DO)	Configuration ► Digital outputs ► Free cooling indication	<ul style="list-style-type: none"> ✓ NC (Normally closed) ✓ NO (Normally open) 	
Running and stopping depending on outdoor temperature	Ventilation ► Demand control ► Free cooling	<ul style="list-style-type: none"> ✓ Running when day outdoor temperature > (°C) ✓ Stop when night outdoor temperature > (°C) ✓ Stop when night outdoor temperature <(°C) 	

Table 4-40 Settings and configuration for Free cooling (continued)

Feature	Menu path in Application tool	Variable	Note
Stop depending on room temperature	Ventilation ► Demand control ► Free cooling	Stop when room temperature < (°C)	
Free cooling start time	Ventilation ► Demand control ► Free cooling	✓ Free cooling start hour (h) ✓ Free cooling stop hour (h)	
Time to block heat output after free cooling	Ventilation ► Demand control ► Free cooling	Time to block heat output after free cooling (min)	
Fan-kick temperature check	Ventilation ► Demand control ► Free cooling	Fan-kick temperature check (s)	
Fan-kick interval time	Ventilation ► Demand control ► Free cooling	Fan-kick interval time (min)	

Table 4-41 Inputs and outputs for free cooling

Inputs and outputs	
AI	Outdoor temperature sensor or Intake temperature
AI	Room sensor or Extract air sensor
DO	Free cooling operation

4.3.10 Cooling recovery

If the cooling recovery has been configured, there is a cooling requirement and the extract air temperature is a settable amount lower than the outdoor temperature, cooling recovery can be activated. When cooling recovery is activated the heat exchanger and damper sequence output signal will be activated in the cooling demand. The function also activates the heating function *Free heating*: if heating is required and the outdoor temperature is higher than the extract air temperature, outdoor air will primarily be used.

Table 4-42 Settings and configuration for Cooling recovery

Feature	Menu path in Application tool	Variable	Note
Select cooling recovery	Configuration ► Functions ► Temperature control	Cooling recovery mode (On / Off)	

Table 4-43 Inputs and outputs for cooling recovery

Inputs and outputs	
AI	Outdoor temperature sensor/Intake temperature sensor
AI	Extract air sensor/Room temperature sensor

4.3.11 Enthalpy control

Calculating the enthalpy means to calculate the energy content of the air, taking into consideration both the temperature and the air humidity. The value is given in energy per kilogram air (kJ/kg). If enthalpy control is configured, enthalpy is calculated both outdoors and for the extract air. Enthalpy control is turned on in the configuration of a sequence (*Configuration ► Functions ► Sequence x ► Enable enthalpy control*). If the enthalpy is higher outdoors than in the extract air, the recirculation damper function (if enthalpy control is configured for the sequence) will be overridden to increase the recirculation. The function is not active when using free cooling, in which case outdoor air is used for cooling the room instead.

If both outdoor sensor and intake sensor are configured it uses the intake sensor. In order for the enthalpy calculation to be made the functions *Enable enthalpy control* (*Configuration ► Functions ► Sequence*) and *Cooling recovery mode* must be active, and four sensors are required:

Table 4-44 Settings and configuration for Enthalpy control

Feature	Menu path in Application tool	Variable	Note
Select enthalpy control	Configuration ► Functions ► Sequence X	Enable enthalpy control	
Select cooling recovery mode	Configuration ► Functions ► Temperature control	Cooling recovery mode (On / Off)	

Table 4-45 Inputs and outputs for enthalpy control

Inputs and outputs	
AI	Outdoor temperature sensor / Intake temperature sensor
AI	Outdoor humidity sensor
AI	Room / Extract air temperature sensor
AI	Room humidity sensor

4.3.12 Heat exchanger efficiency monitoring

The function calculates the heat exchanger temperature efficiency in percent when the output signal to the first exchanger sequence is higher than 5 % (settable) and the extract air/efficiency temperature is 2°C (settable) higher than the outdoor temperature (*Configuration ► Functions ► Temperature control ► Min temperature difference to show efficiency and Min output exchanger to show efficiency*).

When the control signal is lower than 5 % or the outdoor temperature is higher than 10°C the display will show 0 %.

If an intake sensor is configured it will use that for the outdoor temperature.

The heat exchanger efficiency is calculated using the following formula:

<p>Option 1: Efficiency = (Efficiency temp - Outdoor temp) / (Extract air temp - Outdoor temp) * 100</p> <p>Option 2: Efficiency = (Extract air temp - Exhaust air temp) / (Extract air temp - Outdoor temp) * 100</p>
--

Alarm

An alarm is activated if the efficiency falls below the set alarm level (50 %). The alarm limit (trigger value) can be changed in *Alarm status ► 65 Low efficiency exchanger ► Edit ► Alarm trigger value*.



Note! The efficiency temperature sensor should be placed after the heat exchanger but before the heater. It will then replace the exhaust air temperature sensor.

Table 4-46 Settings and configuration for Heat exchanger efficiency monitoring

Feature	Menu path in Application tool	Variable	Note
Actual efficiency value	Ventilation ► Actual / Setpoint ► Exchanger		
Analog input	Configuration ► Analog inputs ► Efficiency temperature exchanger	<ul style="list-style-type: none"> ✓ Sensor type ✓ Min/Max input (V) ✓ Min/Max signal (°C) ✓ Filter factor ✓ Compensation (°C) ✓ Mode ✓ Manual (°C) 	

Table 4-46 Settings and configuration for Heat exchanger efficiency monitoring (continued)

Feature	Menu path in Application tool	Variable	Note
Select efficiency presentation	Configuration ► Functions ► Temperature control	Efficiency presentation (Yes/No)	
Minimum temperature difference to show efficiency	Configuration ► Functions ► Temperature control	Min temperature difference to show efficiency (°C)	

Table 4-47 Inputs and outputs for heat exchanger efficiency monitoring

Inputs and outputs	
AI	Outdoor temperature sensor / Intake temperature sensor
AI	Extract air sensor
AI	Exhaust air sensor
AI	Efficiency temperature sensor

4.3.13 External setpoint

An external setpoint device, e.g. Regin's TBI-PT1000 or TG-R4/PT1000 can be connected. The unit is connected to the analog input signal *External setpoint temperature*.

Table 4-48

Feature	Menu path in Application tool	Variable	Note
Select external setpoint device	Configuration ► Functions ► Temperature control	External setpoint device	
Analog input	Configuration ► Analog inputs ► External setpoint temperature		

Table 4-49 Inputs and outputs for External setpoint

Inputs and outputs	
AI	External setpoint temperature

4.3.14 Recirculation

Recirculation is a function for distributing the air in the room using the supply air fan. The function can be used even when there is no heating or cooling demand. When using recirculation control, the extract air fan stops (but can also be set to run) and a recirculation damper opens which allows the air to circulate through the unit.

Recirculation is activated either via a digital input signal or by connecting it to *Extra time channel 4* (Application tool ► Time control). If a timer output for *Low/Normal/High* speed is activated during recirculation via *Extra time channel 4*, *Low/Normal/High* speed gets priority. If a timer output for *Low/Normal/High* speed is activated during recirculation activated by a digital input, recirculation gets priority.

Either a digital output (*Recirculation damper*) or an analog output sequence A to J can be used as an on/off output signal.

Recirculation control can be configured as either air circulation (*temperature control inactive*) or air circulation with temperature control. (Only heating, only cooling or both heating and cooling). Recirculation control has its own setpoint. However, the other settings are the same as for normal operation, i. e. if normal operation has been configured as room control, room control will also be used during recirculation.

The recirculation setpoint can be configured as constant or offset. Constant means that the recirculation setpoint will be used. Offset is based on an offset from the supply air setpoint.

To lower the temperature, it is possible to configure free cooling to be used during recirculation, if the conditions for free cooling are fulfilled, see 4.3.9 *Free cooling*. Then, when the recirculation damper closes, the supply and extract air dampers open and the extract air fan starts. The supply air fan also starts, if it is not already running. If the free cooling function is not configured for recirculation control and you want to cool down the supply air via a low recirculation setpoint, the cooling battery will be used.

A max. room temperature can be configured for recirculation control under *Ventilation ▶ Demand control ▶ Recirculation*. If the room temperature rises above the set value, recirculation will be stopped. When the room temperature has fallen 1 K below the set max limit, recirculation will start again if the start conditions are still fulfilled.

When running frequency controlled fans and using recirculation control you can, depending on the type of fan control, configure a special pressure/flow offset for the setpoint or a manual output signal for the supply air fan (*Ventilation ▶ Fan control ▶ Fans ▶ Offset ... fan when recirculation*).

It's also possible to configure the output value when recirculation is active for each sequence. The sequence output can be configured to 0%, 100% or modulating 0-100%.

Table 4-50 Settings and configuration for recirculation

Feature	Menu path in Application tool	Variable	Note
Select recirculation	Configuration ▶ Functions ▶ Function activation	Recirculation (Yes/No)	
Select sequence output when recirculation	Configuration ▶ Functions ▶ Sequence X	Sequence output when recirculation/support (Auto, 0%, 100%)	
Setpoint recirculation temperature	Ventilation ▶ Demand control ▶ Recirculation	Setpoint recirculation (°C)	
Temperature for change to outdoor air	Ventilation ▶ Demand control ▶ Recirculation	Change to outdoor air when room air > (°C)	
Recirculation air damper control	Configuration ▶ Digital outputs ▶ Recirculation air damper	✓ NC (Normally closed) ✓ NO (Normally open)	

4.3.15 Extra temperature sensor

The input signals *Extra sensor 1*, *Extra sensor 2*, ..., *Extra sensor 5*, can be used to add extra temperature sensors for supervision of temperatures that are not related to any control functions. Each sensor has three alarms tied to it: High temperature, Low temperature and Sensor error.

Table 4-51 Settings and configuration for extra temperature sensor

Feature	Menu path in Application tool	Variable	Note
Select extra sensors and inputs	Configuration ▶ Functions ▶ Extra sensors & inputs	✓ Alarm acknowledgement ✓ Extra sensors ✓ Extra alarm	
Analog inputs	Configuration ▶ Analog inputs ▶ Extra sensor X	✓ Sensor type ✓ Filter factor ✓ Compensation ✓ Mode ✓ Manual	
Change name of extra sensor	Configuration ▶ Analog inputs ▶ Extra sensor	Title extra sensor X	
Extra alarm	Configuration ▶ Digital inputs ▶ Extra alarmX	✓ NC (Normally closed) ✓ NO (Normally open) Manual / Auto (On, Off, Auto)	

4.4 Fan control

4.4.1 General

The variable speed of the fan is controlled via a frequency converter.

Variable speed control uses an analog output per fan or Modbus communication for controlling a frequency converter. There is one setpoint for each fan for normal, low and high speed. Pressure or air flow control can be used, the offset is in the configured unit (pressure/flow/percent).

Variable speed fans can also be configured to be run with fixed output values (0-100%).

Timer outputs

The fans are normally controlled by the timer channels for slow, normal and high speed but can also be started via a digital input or communication.

Slow, normal and high speed

The units will always start directly with the desired speed.

The extract air fan and the supply air fan have individual start and stop delays which are normally set so that the extract air fan is started before the supply air fan. If there are not enough digital outputs for individual control, both fans will have to be started using the signal for the supply air fan, and the delay will be created using an external time relay.

Speed limits

For both supply air and extract air fans the max and min speed limit will be applied to the output. If the user sets the speed value manually or if the ventilation system stops, this will override the set fan speed limits.

Fan control types

There are different types of fan control. The control type is selected in Application tool ► Configuration ► Functions ► Function activation ► Fan control type. See *Table 4-52* below for a description of the different types.

Table 4-52 Fan control types

Pressure	Control of the fan speed using pressure transmitters.
Flow	Instead of giving a pressure setpoint value, it is possible to use an airflow volume value in m ³ /h. The value from the pressure transmitter is recalculated to a volume flow and the fans will be controlled to give a constant flow.
Manual	Use the manual setting if you want to manually set the speed of the fan
External	Use the external setting if you have an external device that controls the fan speed, e.g. 0...10 V device.
Supply air pressure and extract air fan slave	The speed of the supply air fan is controlled by a pressure transmitter which is placed in the supply air duct. The extract air fan does not have a pressure transmitter, instead you let the output for the extract air fan follow the control signal for the supply air fan. A scaling factor can be added if the characteristics of the extract air fan are not the same as the characteristics of the supply air fan. (Only pressure control of the supply air fan is possible using this function.)
Supply air pressure with extract air flow slave	The speed of the supply air fan is controlled by a pressure transmitter which is placed in the supply air duct. The extract air fan is controlled by the supply air flow, in order to achieve a balanced ventilation. A pressure transmitter which is placed in the supply air fan cone ("SAF flow") gives a measured value of the present supply air flow. A corresponding pressure transmitter is placed in the extract air fan cone and gives a measured value of the extract air flow. The supply air flow is the setpoint used for control of the extract air fan. A scaling factor can be added if the extract air fan does not have the same characteristics as the supply air fan.

Table 4-52 Fan control types (continued)

Extract air pressure with supply air fan slave	The speed of the extract air fan is controlled by a pressure transmitter which is placed in the extract air duct. The supply air fan has no pressure transmitter. Instead, the supply air fan output is made to follow the extract air fan control signal. A scaling factor can be added if the supply air fan characteristics are not the same as the characteristics of the extract air fan (only pressure control of the extract air fan is possible using this function).
Extract air fan pressure with supply air flow slave	The speed of the extract air fan is controlled by a pressure transmitter which is placed in the extract air duct. The supply air fan is controlled by the extract air duct flow in order to achieve a balanced ventilation. A pressure transmitter placed in the extract air fan cone ("EAF flow") provides a measurement of the current extract air flow. A corresponding pressure transmitter is placed in the supply air fan cone, providing a measurement of the supply air flow. The supply air fan is controlled using the extract air flow as a setpoint. A scaling factor can be added if the supply air fan does not have the same characteristics as the extract air fan.

Frequency converters

There is support for the following frequency converters and/or EC controllers:

- ✓ Vacon NXL
- ✓ Lenze
- ✓ Omron V1000
- ✓ Emerson Commander
- ✓ LS
- ✓ EBM
- ✓ Danfoss FC 101
- ✓ ABB ACS
- ✓ Ziehl EC Blue

Read more about the frequency converters in *Appendix F Frequency converters and EC controllers for heat exchangers*

Compensation curve

When running pressure/flow control or manual frequency control, it is possible to for the pressure/flow or output to be compensated. By using compensation, the fan can be run at low speed more of the time. The fan speed will increase only when necessary, thus saving energy.

This compensation can be made depending on any analog input such as supply air, extract air, room, outdoor temperature, humidity, CO₂ etc. There are three equal compensation functions.

It is possible to compensate either one or both fans at the same time. It is possible to set which fan that should be compensated, the supply or extract air fan.

There are three compensation functions called *Fan compensation curve 1...3* which can be used to set a compensation based on the configured analog input signal (temperature, pressure, flow humidity, CO₂). The curve has three parameter pairs which correspond to the value of the compensation at three different temperatures.

The compensation can be selected to apply to both fans or one fan, to low, normal, high or all speeds or only when defrosting.

When configuring in Application tool, you select the following settings for the compensation curve:

Table 4-53 Settings and configuration for fan compensation curve 1, 2, 3

Feature	Menu path in Application tool	Options	Note
Fan level, compensation curve	Configuration ► Functions ► Fan compensation curve 1/2/3 ► Fan level	<ul style="list-style-type: none"> ✓ All levels ✓ Low speed ✓ Normal speed ✓ High speed ✓ Low + Normal speed ✓ Normal + High speed 	
Compensation mode	Configuration ► Functions ► Fan compensation curve 1/2/3	<ul style="list-style-type: none"> ✓ Inactive ✓ In all modes ✓ When defrosting 	
Fan type to compensate	Configuration ► Functions ► Fan compensation curve 1/2/3	<ul style="list-style-type: none"> ✓ Supply air fan + extract air fan ✓ Supply air fan ✓ Extract air fan 	
Sensor used in compensation	Configuration ► Functions ► Fan compensation curve 1/2/3	<ul style="list-style-type: none"> ✓ Outdoor temperature ✓ Intake air temperature ✓ Supply air temperature ✓ Exhaust air temperature ✓ Extract air temperature ✓ Room temperature 1...10 ✓ etc. 	

Setpoints for fan compensation

The setpoints for the compensation curves are in the **Ventilation** section in Application tool.

In *Figure 4-12 Example of fan compensation curve* below is an example of how to compensate the fan depending on the outdoor temperature. The speed of the fan increases at low and high outdoor temperatures. The output of the compensation curve is added to the setpoint of the fan (*Ventilation ► Fan control ► Supply air fan/Extract air fan ► Actual setpoint compensation*).

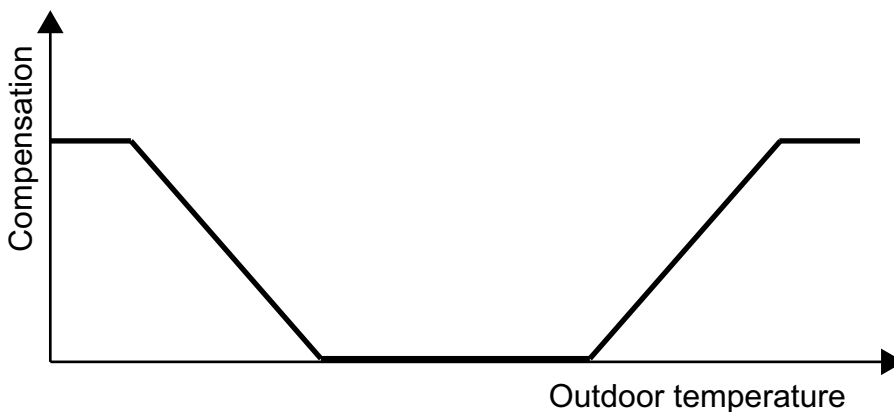

Figure 4-12 Example of fan compensation curve

Feature	Menu path in Application tool	Variable	Description
Select fan speed compensated temperature setpoint	Configuration ► Functions ► Temperature control	Fan speed compensated temperature setpoint	<ul style="list-style-type: none"> ✓ None ✓ Low ✓ High ✓ Low + High
Lower/Middle/Higher point X	Ventilation ► Fan control ► Fan compensation curve 1/2/3	Lower/Middle/Higher point X	Points on the X-axis
Lower/Middle/Higher point Y	Ventilation ► Fan control ► Fan compensation curve 1/2/3	Lower/Middle/Higher point Y	The Y-axis can be in Pa, % or m ³ /h depending on the fan control type.

Timer outputs

The fans are normally controlled by the timer channels for low, normal and high speed but can also be started via digital input or communication. (Application tool ► Time control)

Fan levels

A frequency controlled fan is the only type of fan that works with the Corrigo. The fan can be set to *Low*, *Normal* or *High* speed. The selection of the fan speed defines which IOs and time channels will be active in the application.

The fans will always start directly with the desired speed.

There are four different fan speed levels to choose from in Application tool:

- ✓ Normal
- ✓ Low - Normal
- ✓ Normal - High
- ✓ Low - Normal - High

Variable speed control uses an analogue output per fan or Modbus communication for controlling a frequency converter.

For more information about frequency converters, see *Appendix F Frequency converters and EC controllers for heat exchangers*

The fans are normally controlled by the timer channels for slow, normal and high speed but can also be started via digital input or communication.

The extract air fan and the supply air fan have individual start and stop delays which are normally set so that the extract air fan is started before the supply air fan. If there are not enough digital outputs for individual control, both fans will have to be started using the signal for the supply air fan, and the delay will be created using an external time relay.

Application tool menu path for fan control

Feature	Menu path in Application tool	Variable	Note
Fan control type	Configuration ► Functions ► Function activation	Fan control type	
Fan levels	Configuration ► Functions ► Function activation	Fan levels	<ul style="list-style-type: none"> ✓ Normal ✓ Low-Normal ✓ Normal-High ✓ Low-Normal-High
Select fan	Configuration ► Functions ► Fan control	<ul style="list-style-type: none"> ✓ Supply air + Extract air ✓ Supply air ✓ Extract air 	
Select flow presentation	Configuration ► Functions ► Fan control	Flow presentation	<ul style="list-style-type: none"> ✓ Yes ✓ No
Fan indication	Configuration ► Functions ► Fan control	Supply/ Extract air fan indication	<ul style="list-style-type: none"> ✓ None ✓ Alarm ✓ Run indication
Extract air fan slaved by exchanger supply air flow	Configuration ► Functions ► Fan control	Extract air fan slaved by exchanger supply air flow (Yes/ No)	

Feature	Menu path in Application tool	Variable	Note
K-factor	Configuration ► Functions ► Fan control	<ul style="list-style-type: none"> ✓ Flow calculation supply air K-factor ✓ Flow calculation extract air K-factor ✓ Flow calculation exchanger supply air K-factor ✓ Flow calculation exchanger extract air K-factor 	
X-factor	Configuration ► Functions ► Fan control	<ul style="list-style-type: none"> ✓ Flow calculation supply air X-factor ✓ Flow calculation extract air X-factor ✓ Flow calculation exchanger supply air X-factor ✓ Flow calculation exchanger extract air X-factor 	
Setpoint, external flow	Configuration ► Functions ► Fan control	External flow setpoint (Yes/No)	
Analog inputs flow supply air	Configuration ► Analog inputs ► Flow supply air	<ul style="list-style-type: none"> ✓ Sensor type ✓ Min/Max input (V) ✓ Min/Max signal (m³/h) ✓ Filter factor ✓ Compensation (m³/h) ✓ Mode ✓ Manual (m³/h) 	
Analog inputs flow extract air	Configuration ► Analog inputs ► Flow extract air	<ul style="list-style-type: none"> ✓ Sensor type ✓ Min/Max input (V) ✓ Min/Max signal (m³/h) ✓ Filter factor ✓ Compensation (m³/h) ✓ Mode ✓ Manual (m³/h) 	
Analog inputs flow exchanger supply air	Configuration ► Analog inputs ► Flow exchanger supply air	<ul style="list-style-type: none"> ✓ Sensor type ✓ Min/Max input (V) ✓ Min/Max signal (m³/h) ✓ Filter factor ✓ Compensation (m³/h) ✓ Mode ✓ Manual (m³/h) 	
Feedback Supply/Extract air fan	Configuration ► Digital inputs ► Feedback supply/extract air fan	<ul style="list-style-type: none"> ✓ NC (Normally closed) ✓ NO (Normally Open) Mode (On/Off/Auto)	
Analog output Supply / Extract fan	Configuration ► Analog outputs ► Supply / Extract air fan	Range output: <ul style="list-style-type: none"> ✓ 0-10V ✓ 2-10 V ✓ 10-2 V ✓ 10-0 V 	
Actual values Supply/Extract air fan	Ventilation ► Actual/Setpoint ► Supply air fan / Extract air fan	<ul style="list-style-type: none"> ✓ Pressure supply / extract air ✓ Flow supply / extract air ✓ Actual setpoint compensation ✓ Actual setpoint ✓ Output signal ✓ Bus values SAF 1...5 Frequency (from frequency converter) ✓ Current (from frequency converter) ✓ Power (from frequency converter) ✓ Error (from frequency converter) 	

Feature	Menu path in Application tool	Variable	Note
Setpoints for fans	Ventilation ► Fan control ► Fans	<ul style="list-style-type: none"> ✓ Setpoint low/normal/high speed supply air fan (% , Pa, m³/h) ✓ Setpoint low/normal/high speed extract air fan (% , Pa, m³/h) ✓ Flow supply/extract air (m³/h) ✓ Slave factor ✓ Offset supply/extract air when free cooling (% , Pa, m³/h) ✓ Offset supply/extract air when recirculation (% , Pa, m³/h) 	
Setpoint supply/extract air fan	Ventilation ► Fan control ► Supply air fan/Extract air fan	<ul style="list-style-type: none"> ✓ Start/stop delay ✓ Outdoor air damper stop delay ✓ Min pressure for supply/extract air fan indication ✓ Min flow for supply/extract air fan indication ✓ SAF speed min/max limit (%) ✓ EAF speed min/max limit (%) 	

4.4.2 Fan control types

Pressure

During pressure control, two separate analog output signals are used for supply and extract air and two separate analogue input signals for supply and extract air for pressure transmitters. The fan speeds are controlled via frequency converters, thereby maintaining constant pressure. The pressure transmitter inputs are scalable using Min input (V) and Max input (V).

A digital output signal is normally used for each fan (*Supply air fan start/step 1* and *Extract air fan start/step 1*) for sending a start signal to the frequency converters. The start signal is activated as long as the fan is expected to be running and the control signal is > 0%.

For the supply and extract air fans, there is one individually settable value for normal speed, for low and high speed. Changing between the speed setpoint values is done using the timer channels or using digital input signals (*Extended Operation low/normal/high speed*).

Settings and configuration for Pressure control

Feature	Menu path in Application tool	Variable	Note
Select pressure control	Configuration ► Functions ► Function activation	Fan control type	
Fan levels	Configuration ► Functions ► Function activation	Fan levels	<ul style="list-style-type: none"> ✓ Normal ✓ Low-Normal ✓ Normal-High ✓ Low-Normal-High
Select fan	Configuration ► Functions ► Fan control	<ul style="list-style-type: none"> ✓ Supply air + Extract air ✓ Supply air ✓ Extract air 	
Analog inputs pressure supply air	Configuration ► Analog inputs ► Pressure supply air	<ul style="list-style-type: none"> ✓ Sensor type ✓ Min/Max input (V) ✓ Min/Max signal (Pa) ✓ Filter factor ✓ Compensation (Pa) ✓ Mode ✓ Manual (Pa) 	

Feature	Menu path in Application tool	Variable	Note
Analog inputs pressure extract air	Configuration ► Analog inputs ► Pressure extract air	<ul style="list-style-type: none"> ✓ Sensor type ✓ Min/Max input (V) ✓ Min/Max signal (Pa) ✓ Filter factor ✓ Compensation (Pa) ✓ Mode ✓ Manual (Pa) 	
Feedback Supply/Extract air fan	Configuration ► Digital inputs ► Feedback supply/extract air fan	<ul style="list-style-type: none"> ✓ NC (Normally closed) ✓ NO (Normally Open) Mode (On/Off/Auto) 	
Analog output Supply / Extract fan	Configuration ► Analog outputs ► Supply / Extract air fan	Range output: <ul style="list-style-type: none"> ✓ 0-10V ✓ 2-10 V ✓ 10-2 V ✓ 10-0 V 	
Actual values Supply/Extract air fan	Ventilation ► Actual/Setpoint ► Supply air fan / Extract air fan	<ul style="list-style-type: none"> ✓ Pressure supply / extract air ✓ Flow supply / extract air ✓ Actual setpoint compensation ✓ Output signal ✓ Bus values SAF 1...5 Frequency (from frequency converter) ✓ Current (from frequency converter) ✓ Power (from frequency converter) ✓ Error (from frequency converter) 	
Setpoints for fans	Ventilation ► Fan control ► Fans	<ul style="list-style-type: none"> ✓ Setpoint low/normal/high speed supply air fan (% , Pa, m³/h) ✓ Setpoint low/normal/high speed extract air fan (% , Pa, m³/h) ✓ Flow supply/extract air (m³/h) ✓ Slave factor ✓ Offset supply/extract air when free cooling (% , Pa, m³/h) ✓ Offset supply/extract air when recirculation (% , Pa, m³/h) 	
Setpoint supply/extract air fan	Ventilation ► Fan control ► Supply air fan / Extract air fan	<ul style="list-style-type: none"> ✓ Start/stop delay ✓ Outdoor air damper stop delay ✓ Min pressure for supply/extract air fan indication ✓ Min flow for supply/extract air fan indication 	

Flow

Instead of giving a pressure setpoint value, it is possible to use an airflow volume value in m³/h. The value from the pressure transmitter is recalculated to a volume flow using the formula below and the fans will be controlled to give a constant flow.

$$\text{Flow} = K * \Delta P^X$$

K and X are settable constants depending on the fan size. ΔP is the differential pressure over the fan in Pa. Each fan has its own set of parameters.

X is normally 0.5 indicating that the flow is proportional to the square root of the differential pressure.

Table 4-54 Settings for K- and X-factor

Feature	Menu path in Application tool	Variable	Description
K-factor	Configuration ► Functions ► Fan control	<ul style="list-style-type: none"> ✓ Flow calculation supply air K-factor ✓ Flow calculation extract air K-factor ✓ Flow calculation exchanger supply air K-factor ✓ Flow calculation exchanger extract air K-factor 	
X-factor	Configuration ► Functions ► Fan control	<ul style="list-style-type: none"> ✓ Flow calculation supply air X-factor ✓ Flow calculation extract air X-factor ✓ Flow calculation exchanger supply air X-factor ✓ Flow calculation exchanger extract air X-factor 	

Manual

Manual control of the fan is set in *Ventilation ► Manual/Auto*.

Frequency controlled fans can be controlled at a fixed rotational speed. The rotational speed is selected by setting a fixed output signal (0 – 100%). There is one individual setpoint value for normal speed, for low speed and high speed.

Fans that are run with a fixed output signal can also be compensated (see the section above). In this mode, pressure sensors are not needed.

External

This signal can be used to control the SAF and EAF flow setpoints from an external VAV system if the "Frequency control external" fan type is used.

If this signal is configured as an analog input signal, the flow setpoint for the SAF and EAF will be controlled in normal speed.

The signal can be configured by using scaling: Min volt input (Vmin)/Min flow and Max volt input (Vmax)/Max flow. The configuration is done in *Configuration ► Analog inputs ► External control supply air fan* and *External control extract air fan*

Supply air pressure and extract air fan slave

The rotational speed of the supply air fan is controlled by a pressure transmitter which is placed in the supply air duct. The extract air fan does not have a pressure transmitter, instead you let the output for the extract air fan follow the control signal for the supply air fan. A scaling factor can be added if the characteristics of the extract air fan are not the same as the characteristics of the supply air fan.



Note! Only pressure control of the supply air fan is possible using this function.

The extract air fan will start directly at 50% after the start delay. Then the heating of the exchanger will work for this operating mode as well. When the supply air fan starts, the extract air fan will be slave controlled by the supply air flow.

Supply air pressure with extract air flow slave

The rotational speed of the supply air fan is controlled by a pressure transmitter which is placed in the supply air duct. The extract air fan is controlled by the supply air flow, in order to achieve a balanced ventilation. A pressure transmitter which is placed in the supply air fan cone (*SAF flow*) gives a measured value of the present supply air flow. A corresponding pressure transmitter is placed in the extract air fan cone and gives a measured value of the extract air flow.

The supply air flow is the setpoint used for control of the extract air fan. A scaling factor can be added if the extract air fan does not have the same characteristics as the supply air fan. The scaling factor is found in *Ventilation ▶ Fan control ▶ Slave factor*

Extract air pressure with supply air fan slave

The rotational speed of the extract air fan is controlled by a pressure transmitter which is placed in the extract air duct. The supply air fan has no pressure transmitter. Instead, the supply air fan output is made to follow the extract air fan control signal. A scaling factor can be added if the supply air fan characteristics are not the same as the characteristics of the extract air fan (only pressure control of the extract air fan is possible using this function). The scaling factor is found in *Ventilation ▶ Fan control ▶ Slave factor*.

Extract air fan pressure with supply air flow slave

The rotational speed of the extract air fan is controlled by a pressure transmitter which is placed in the extract air duct. The supply air fan is controlled by the extract air duct flow in order to achieve a balanced ventilation. A pressure transmitter placed in the extract air fan cone (*EAF flow*) provides a measurement of the current extract air flow. A corresponding pressure transmitter is placed in the supply air fan cone, providing a measurement of the supply air flow.

The supply air fan is controlled using the extract air flow as a setpoint. A scaling factor can be added if the supply air fan does not have the same characteristics as the extract air fan. The scaling factor is found in *Ventilation ▶ Fan control ▶ Slave factor*

Step controlled fans

It is possible to control the speed of the fans via digital outputs if the type of fan control is set to *Manual* or *External* (*Configuration ▶ Functions ▶ Function activation ▶ Fan control type*).

Fans with up to 3 speeds can be controlled by this function (*Configuration ▶ Functions ▶ Fan control ▶ Step control of fans*). The function converts the control signal of the fan to start/stop signals for the step outputs.

Switch points and hysteresis are settable parameters (*Configuration ▶ Functions ▶ Fan control ▶ Switch point step 1-2 SAF / 2-3 SAF / 1-2 EAF / 2-3 EAF (%)*, *Hysteresis (%)*). The switch between the steps of the fans is delayed by a timer *Speed change delay (s)* (FS = 10s) (*Ventilation ▶ Fan control ▶ Supply air fan/Extract air fan*). When increasing the speed, the fan must run at the lower speed for the set delay time before the next higher speed is activated. If the speed is reduced, the output of the higher stage is switched off and the lower stage is switched on after the delay time has expired. Only the output of the selected speed is active.

Table 4-55 Settings and configuration for step control of fans

Feature	Menu path in Application tool	Variable	Note
Select Fan control type	Configuration ▶ Functions ▶ Function activation	Fan control type	<ul style="list-style-type: none"> ✓ Manual ✓ External
Step control of fans	Configuration ▶ Functions ▶ Fan control	Step control of fans	<ul style="list-style-type: none"> ✓ No ✓ 1 step ✓ 2 steps ✓ 3 steps
Switch points	Configuration ▶ Functions ▶ Fan control	Switch point x	

Table 4-55 Settings and configuration for step control of fans (continued)

Feature	Menu path in Application tool	Variable	Note
Hysteresis	Configuration ► Functions ► Fan control	Hysteresis	
Digital outputs	Configuration ► Digital outputs	<ul style="list-style-type: none"> ✓ Supply air fan start/step1 ✓ Supply air fan step 2 ✓ Supply air fan step 3 ✓ Extract air fan start/step 1 ✓ Extract air fan step 2 ✓ Extract air fan step 3 	
Delay time	Ventilation ► Fan control ► Supply air fan	Speed change delay	
Delay time	Ventilation ► Fan control ► Extract air fan	Speed change delay	

Kitchen function

Kitchen function is an additional function for external controlled fans; *Fan control type = External*. The function will stop the unit if the external control signal is lower than a settable limit. A potentiometer which is connected to an analog input can start and stop the air handling unit in addition to control the speed of the fans.

The following settings need to be done to get the function activated:

- ✓ Fan control type = External (*Configuration ► Functions ► Function activation ► Fan control type*)
- ✓ Kitchen function = Yes (*Configuration ► Functions ► Fan control ► Kitchen function*)
- ✓ Analog input: External control supply air fan and External control extract fan (*Configuration ► Analog inputs*) configured to the same physical input

Different speeds of the fans can be achieved by differently adjusted curves for the two analog inputs. (*Configuration ► Analog inputs ► External control xxx fan ► Min/Max input (V), Min/Max signal(%)*). The unit will stop if the voltage at the input *External control supply air fan* falls below the Min input (V). It starts again if the signal rises above the Min input (V) + a fix hysteresis of 0,1V.

Table 4-56 Settings and configuration for kitchen function

Feature	Menu path in Application tool	Variable	Note
Select Fan control type	Configuration ► Functions ► Function activation	Fan control type	External
Kitchen function	Configuration ► Functions ► Fan control	Kitchen function	<ul style="list-style-type: none"> ✓ No ✓ Yes
Analog inputs	Configuration ► Analog inputs	<ul style="list-style-type: none"> ✓ External control supply air fan ✓ External control extract air fan 	

4.4.3 Demand controlled ventilation

In applications with varying occupancy the fan speeds or mixing dampers can be controlled by the air quality as measured by a CO₂ sensor.

With the CO₂ function it's possible to start and stop the fans, compensate the fan speed and in combination with mixing damper let in more outdoor air depending on the CO₂ value.

When the function is activated with start/stop function and the CO₂ value rises above a settable start value (default: 800 ppm) the fans will start at configured speed (default: normal speed), if they are not already running. Should the CO₂ value continue to rise, the fan speed can increase if compensation with CO₂ value

is configured (See function *Fan compensation curve 1 in Application tool*). The fans will stop when the CO₂ value falls a settable hysteresis (default: 160 ppm) below the start value.

If demand controlled ventilation is activated in combination with mixing dampers and the CO₂-value rises above the setpoint value, the dampers controlled by a sequence with CO₂ function will be overtaken by the CO₂ controller and let in more outdoor air. The function is controlled by a PI-controller.

The function has a settable minimum running time.

Application tool menu paths for Demand control

Table 4-57 Settings and configuration for Demand control

Feature	Menu path in Application tool	Variable	Note
Select type of CO ₂ control	Configuration ► Functions ► Function activation	CO ₂ control: ✓ No ✓ Fan start/stop function ✓ Mixing damper function ✓ Fan start/stop + Mixing damper	
CO ₂ control in sequence	Configuration ► Functions ► Sequence X	CO ₂ control (No/CO ₂ Sequence 1, 2)	
CO ₂ control mode	Configuration ► Functions ► Sequence X	CO ₂ control mode (Increasing/Decreasing)	
Analog input CO ₂ room/Extract air	Configuration ► Analog inputs ► CO ₂ room/extract air	✓ Sensor type ✓ Min/Max input (V) ✓ Min/Max signal (ppm) ✓ Filter factor ✓ Compensation (ppm) ✓ Mode ✓ Manual (ppm)	
Setpoints CO ₂ control	Ventilation ► Demand control ► CO ₂	✓ Setpoint mixing damper (ppm) ✓ Start limit fan start/stop (ppm) ✓ Stop hysteresis fan start/stop (ppm) ✓ Min time for CO ₂ control (min)	
PID settings	Ventilation ► PID controllers ► CO ₂	✓ P-band (ppm) ✓ I-time (s) ✓ D-time (s)	

Inputs and outputs for Demand control

Inputs and Outputs	
AI	CO ₂ sensors

4.4.4 Extra fan motor control

External control of two external fan motors can be configured. The fans are started via either a digital input, extra time channel 4 or when the unit is started.

A digital output activates the fan motor. A digital input is available for run indication / motor protection.

Table 4-58 Settings and configuration for Extra fan motor control

Feature	Menu path in Application tool	Variable	Note
Select Extra fan motor control	Configuration ► Functions ► Function activation	Extra fan motor control (No, 1, 2)	
Feedback and start/stop of extra fan motor	Configuration ► Functions ► Extra fan motor control	✓ Type of feedback fan motor 1, 2 (None, Alarm, Run Indication) ✓ Start/stop function fan motor 1, 2 (Digital input, Unit running, Extra time channel 4)	
Digital input Start/Stop extra fan motor	Configuration ► Digital inputs ► Start/(Stop) extra fan motor 1, 2	✓ NC (Normally closed) ✓ NO (Normally open) Manual / Auto	
Digital input Feedback extra fan motor 1, 2	Configuration ► Digital inputs ► Feedback extra fan motor 1, 2	✓ NC (Normally closed) ✓ NO (Normally open) Manual / Auto	
Digital output extra fan motor 1, 2 start	Configuration ► Digital outputs ► Extra fan motor 1, 2 start	✓ NC (Normally closed) ✓ NO (Normally open)	
Extra time channel 4	Time control ► Extra time channel 4		

Table 4-59 Inputs and outputs extra fan motor control

Motor control 1	Motor control 2	
DI	DI	Start/(Stop) extra fan motor
DI	DI	Feedback extra fan motor
DO	DO	Extra fan motor start

4.5 Pump control

Digital inputs and outputs can be configured for pump control.

All the pumps can use run indication with malfunction alarm, or an alarm input connected to a motor protection or similar.

4.5.1 Heating circuit, water heating

The circulation pump for the heating sequence will always run when the outdoor temperature is lower than a settable value (FS +10°C) (*Ventilation ► Temperature control ► Sequence x ► Pump running when temperature < (°C)*). At higher outdoor temperatures the pump will run when the sequence output signal is larger than 0 V.

If no outdoor temperature sensor has been configured, the stop temperature can be set to 0°C. Then the pump will only run on heat demand.

The pump has a settable stop delay.

The pump will be exercised once daily at a settable time (FS: 15:00 / 3 p.m.) for one minute or the set shortest running time, whichever is the longest.

4.5.2 Exchanger circuit, liquid connected exchangers

The circulation pump for the exchanger sequence will run when the sequence output signal is larger than 0 V.

The pump has a settable, shortest running time.

The pump will be exercised once daily at a settable time (FS: 15:00 / 3 p.m.) for 1 minute, or the set stop delay, whichever is the longest.

4.5.3 Cooling circuit

The circulation pump for the cooling sequence will run when the sequence output signal is larger than 0 V.

The pump has a settable, shortest running time.

The pump will be exercised once daily at a settable time (FS: 3 p.m.) for 1 minute, or the set stop delay, whichever is the longest.

4.5.4 Settings and configuration in Application tool for pump control

Table 4-60 Settings and configuration for pump control

Feature	Menu path in Application tool	Variable	Note
Select pump control	Configuration ► Functions ► Sequence A to J	Pump control (Yes / No)	
Pump stop mode	Configuration ► Functions ► Sequence A to J	Pump stop mode (Auto / Always running)	
Type of pump indication	Configuration ► Functions ► Sequence A to J	Type of pump indication (None / Alarm / Run indication)	
Digital output	Configuration ► Digital outputs ► Sequence A to J pump	<ul style="list-style-type: none"> ✓ NC (Normally closed) ✓ NO (Normally open) 	
Setpoints pump	Ventilation ► Temperature control ► Sequence A to J	<ul style="list-style-type: none"> ✓ Pump stop delay (min) ✓ Pump-kick hour (h) ✓ Pump running when outdoor temperature < (°C) ✓ Hysteresis to allow pump stop (°C) 	

4.5.5 Inputs and outputs for pump control

Table 4-61 Inputs and outputs for pump control

Heating	Exchanger	Cooling	
AI	-	-	Outdoor temperature sensor
DO	DO	DO	Start / Stop circulation pump
DI	DI	DI	Run indication / alarm, circulation pump

4.6 Damper control

4.6.1 Close-off dampers

The outdoor air and exhaust air ducts close-off dampers can be controlled by digital outputs or be hard-wired to the supply air fan relays for normal, low and high speed so that the damper is open when the supply air fan is running. When using pressure controlled fans the digital activation signal is activated as soon as the fan has start conditions. This signal can be used to open the close-off damper.

Select damper type in *Configuration ► Functions ► Function activation*.

When the unit is stopped it's possible to configure a delay time before the *Outdoor air damper* and *Exhaust air damper* is closing.

- ✓ Outdoor air damper close delay: 0-300 seconds (Default: 0 s) (*Ventilation ▶ Fan control ▶ Supply air fan ▶ Outdoor air damper stop delay (s).*)
- ✓ Exhaust air damper close delay: 0-300 seconds (Default: 0 s)(*Ventilation ▶ Fan control ▶ Extract air fan ▶ Exhaust air damper stop delay (s).*)

Table 4-62 Settings and configuration of Close-off dampers

Feature	Menu path in Application tool	Variable	Note
Select damper type	Configuration ▶ Functions ▶ Function activation	Damper: ✓ None ✓ Outdoor ✓ Outdoor + Exhaust ✓ Exhaust	
Digital output outdoor air damper	Configuration ▶ Digital outputs ▶ Outdoor air damper	✓ NC (Normally closed) ✓ NO (Normally open)	
Digital output exhaust air damper	Configuration ▶ Digital outputs ▶ Exhaust air damper	✓ NC (Normally closed) ✓ NO (Normally open)	

4.6.2 Fire/smoke dampers

Fire dampers are normally configured to open on fire alarm but can be configured to be normally open instead.

Fire damper exercising

Fire damper exercising can be configured. The exercise interval is settable. To be able to use this function, all the dampers must have end-position switches.

The digital input *Feedback fire damper* should be wired to all the fire damper end position switches (*Configuration ▶ Digital inputs ▶ Feedback fire damper*).

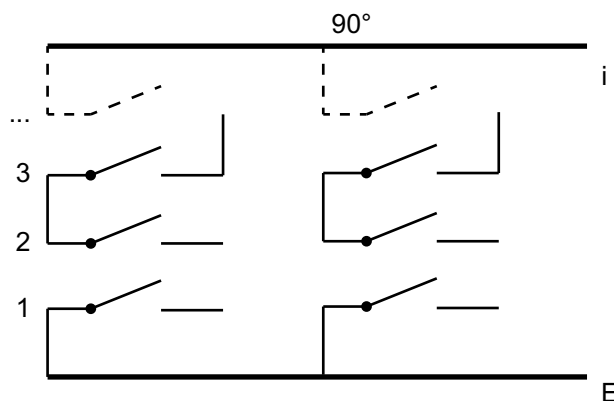

Figure 4-13 Dampers

When the test cycle is initiated, the digital output *Fire damper* will be activated and the dampers will begin to move. Within the set time (90 s) the signal *Feedback fire damper* change to indicate that the dampers have left their normal positions. If not, an alarm will be triggered.

Then, within the set time, *Feedback fire damper* must change again to indicate that all the dampers have reached the other end position. If not, an alarm will be triggered.

When all dampers have reached the end position the output *Fire damper* will be reset to drive the dampers back to normal position. Again, within the set time (90 s) the signal on the digital input *Feedback fire damper* must change to indicate that the dampers have left the end positions. If not an alarm will be triggered.

Then, within the set time, *Feedback fire damper* must change again to indicate that all the dampers are back to their normal positions. If not an alarm will be triggered.

The controller can be configured to stop the air handling unit during the damper testing at *Configuration ► Functions ► Fire/Smoke ► Fire damper test*, where it's possible to select if the test will be when the unit is running or stopped.

All dampers must be wired to the same output in order to get correct results.

The fire alarm input can be configured as normally closed or normally open (*Configuration ► Digital inputs ► Fire Alarm*).

Table 4-63 Settings and configuration of fire and/or smoke dampers

Feature	Menu path in Application tool	Variable	Note
Select fire and/or smoke	Configuration ► Functions ► Function activation	Fire / Smoke: <input checked="" type="checkbox"/> No <input checked="" type="checkbox"/> Fire <input checked="" type="checkbox"/> Smoke <input checked="" type="checkbox"/> Fire + Smoke	
Select operation mode when fire/smoke alarm	Configuration ► Functions ► Fire/Smoke	Operation mode when fire/smoke alarm: <input checked="" type="checkbox"/> Stopped <input checked="" type="checkbox"/> Continuous run <input checked="" type="checkbox"/> Running via normal start/stop conditions <input checked="" type="checkbox"/> Supply air fan run <input checked="" type="checkbox"/> Extract air fan run	
Supply air fan setpoint type when fire/smoke alarm	Configuration ► Functions ► Fire/Smoke	Supply air fan setpoint type when fire/smoke alarm: <input checked="" type="checkbox"/> Auto <input checked="" type="checkbox"/> Manual setpoint <input checked="" type="checkbox"/> Manual output <input checked="" type="checkbox"/> Low speed setpoint <input checked="" type="checkbox"/> Normal speed setpoint <input checked="" type="checkbox"/> High speed setpoint	
Manual setpoint supply air	Configuration ► Functions ► Fire/Smoke	Manual setpoint (Pa, m ³ /h, %)	
Manual output supply air	Configuration ► Functions ► Fire/Smoke	Manual output (%)	
Extract air fan setpoint type when fire/smoke alarm	Configuration ► Functions ► Fire/Smoke	Supply air fan setpoint type when fire/smoke alarm: <input checked="" type="checkbox"/> Auto <input checked="" type="checkbox"/> Manual setpoint <input checked="" type="checkbox"/> Manual output <input checked="" type="checkbox"/> Low speed setpoint <input checked="" type="checkbox"/> Normal speed setpoint <input checked="" type="checkbox"/> High speed setpoint	
Manual setpoint extract air	Configuration ► Functions ► Fire/Smoke	Manual setpoint (Pa, m ³ /h, %)	
Manual output extract air	Configuration ► Functions ► Fire/Smoke	Manual output (%)	
Outdoor air damper function when fire/smoke alarm	Configuration ► Functions ► Fire/Smoke	Outdoor air damper function when fire/smoke alarm: <input checked="" type="checkbox"/> Normal function (follow the fan) <input checked="" type="checkbox"/> Always open <input checked="" type="checkbox"/> Always closed	

Table 4-63 Settings and configuration of fire and/or smoke dampers (continued)

Feature	Menu path in Application tool	Variable	Note
Exhaust air damper function when fire/smoke alarm	Configuration ► Functions ► Fire/Smoke	Exhaust air damper function when fire/smoke alarm: ✓ Normal function (follow the fan) ✓ Always open ✓ Always closed	
Fire damper mode	Configuration ► Functions ► Fire/Smoke	Fire damper mode ✓ Not active ✓ Dampers normally closed ✓ Dampers normally opened	
Fire damper test	Configuration ► Functions ► Fire/Smoke	Fire damper test ✓ No test ✓ Test when unit running ✓ Test when unit stopped	
Digital input Feedback fire damper	Configuration ► Digital inputs ► Feedback fire damper	✓ NC (Normally closed) ✓ NO (Normally open)	
Digital input Fire/Smoke alarm	Configuration ► Digital inputs ► Fire/Smoke alarm	✓ NC (Normally closed) ✓ NO (Normally open)	
Digital output fire damper	Configuration ► Digital outputs ► Fire damper	✓ NC (Normally closed) ✓ NO (Normally open)	
Sequence output when fire / smoke mode	Configuration ► Functions ► Sequence A to J	Sequence output when fire / smoke mode	
Setpoints fire damper	Ventilation ► Fire/Smoke ► Fire/Smoke	✓ Run time fire damper (s) ✓ Test interval fire damper (d) ✓ Test hour fire damper (h)	

4.6.3 Inputs and outputs for dampers

Inputs and Outputs	
DO	Outdoor air damper
DO	Exhaust air damper
DO	Fire damper
DI	Fire alarm
DI	Smoke alarm
DI	Feedback fire alarm

4.7 Pretreatment

Control of dampers and pump for preheated or pre-cooled outdoor air via an underground intake channel.

The digital output *Pretreatment* is set to preheating when the unit is started and the outdoor temperature is below the set heating start limit (default 8°C) or to precooling when the outdoor temperature is above the set cooling start limit (default 19°C).

If the outdoor temperature exceeds the set heating start limit by more than 1°C, preheating will be stopped, as well as if the outdoor temperature falls below the cooling start limit by 1°C.

If a sensor is configured in the intake duct this temperature will be compared with the outdoor temperature. If the temperature in the intake duct does not exceed the outdoor temperature by more than 1°C (adjustable) 5 minutes (adjustable) after start-up when using preheating, preheating will be stopped. The same conditions apply to precooling, i.e. if the intake temperature is not more than 1°C (adjustable) cooler than the outdoor temperature, precooling will be stopped.

Pretreatment always starts at start-up of the unit, if the outdoor temperature so permits. If pretreatment is stopped due to a small difference between the intake temperature and the outdoor temperature, pretreatment will be blocked for 6 hours. Then pretreatment will start (if the outdoor temperature so permits) and run for at least 5 minutes (adjustable)

Feature	Menu path in Application tool	Variable	Note
Select pretreatment	Configuration ► Functions ► Function activation	Pretreatment (Yes/No)	
Select if pretreatment activated during free cooling	Configuration ► Functions ► Pretreatment	Pretreatment activated during free cooling (Yes / No)	
Intake sensor configuration	Configuration ► Analog inputs ► Intake air temperature	Sensor type	
Digital output: Pretreatment start	Configuration ► Digital outputs ► Pretreatment start	<ul style="list-style-type: none"> ✓ NC (Normally closed) ✓ NO (Normally open) 	
Setpoints pretreatment	Ventilation ► Temperature control ► Pretreatment	<ul style="list-style-type: none"> ✓ Activate preheater when outdoor temperature < (°C) ✓ Activate precooler when outdoor temperature > (°C) ✓ Hysteresis (°C) ✓ Min difference between outdoor and intake air temperature (°C) ✓ Pretreatment block time if difference below min (h) ✓ Min run time (min) 	

4.8 Humidity control

Humidity control can be configured as Humidification, Dehumidification or both Humidification and Dehumidification.

Two humidity sensors can be connected, a room sensor for control and an optional duct sensor for maximum limiting. The limit sensor can be omitted.

The humidity control is handled by a PI-controller.

The humidity sensors must give 0...10 V DC for 0...100 % RH.

4.8.1 Humidification

An analog output is used to control a humidifier. The output will increase on decreasing humidity. A digital output can also be used to start a humidifier.

Maximum limitation function using duct humidity sensor:

If the maximum limitation is 80 % RH and the hysteresis is 20 % RH, the controller output signal will begin decreasing at 60 % RH. When halfway to 80 % RH (i.e. when at 70 % RH), half the output signal will be damped. If the humidity in the duct still reaches 80 % RH, the entire output signal will be damped.

4.8.2 Dehumidification

An analogue output (*Humidity control*) is used to control a dehumidifier. The output will increase on increasing humidity. A digital output can also be used to start a dehumidifier.

4.8.3 Humidification / Dehumidification

An analogue output (*Humidity control*) is used to control a humidifier. The output will increase on decreasing humidity.

For dehumidification it's configurable which sequence that should be activated for dehumidification through condensation. The parameter for configuration is at *Configuration ▶ Functions ▶ Humidity control ▶ Select sequence for dehumidify*. The output will increase on increasing humidity. This signal overrides the cooling signal from the temperature controller so the output can be activated for dehumidification even if the temperature controller demand is zero.



Note! For good temperature control when using cooling for dehumidification it is important that the cooler is placed first in the air stream so that the exchanger and heater can be used to reheat the air after dehumidification.

4.8.4 Digital humidity signal

A digital output signal, *Humidity control start*, can be used for on/off control of humidifiers/dehumidifiers. The output signal has an activation value and a deactivation value which are connected to the humidity controller output. The signal is activated when the humidity controller output rises above the set activation value and is deactivated when the humidity controller output drops below the set deactivation value.

Setpoints are found in *Ventilation ▶ Humidity control*

If a start signal is needed for a cooling unit or a magnetic valve for DX dehumidification, the digital output signal for the configured sequence *Sequence x pump* should be used. In this case, the *pump stop delay* should be set to 0 s (*Ventilation ▶ Temperature control ▶ Sequence x ▶ Pump stop delay*).

4.8.5 Settings and configuration for Humidity control

Feature	Menu path in Application tool	Variable	Note
Select Humidity control type	Configuration ▶ Functions ▶ Function activation	<ul style="list-style-type: none"> ✓ No ✓ Humidification ✓ Dehumidification ✓ Humidification + Dehumidification 	
Select Sensor	Configuration ▶ Functions ▶ Temperature control	Room temperature sensor (1...16) etc.	
Select sequence for dehumidify	Configuration ▶ Functions ▶ Humidity control	Select sequence for dehumidify	
Select type of output	Configuration ▶ Functions ▶ Humidity control	Select type of output <ul style="list-style-type: none"> ✓ Analog ✓ Step ✓ Analog + Step 	
Analog inputs: Humidity room/ extract air / Supply air / Outdoor	Configuration ▶ Analog inputs ▶ Humidity room/extract air / Supply air / Outdoor	<ul style="list-style-type: none"> ✓ Sensor type ✓ Min / max input (V) ✓ Min / max signal (%RH) ✓ Compensation (%RH) ✓ Mode ✓ Manual (%RH) 	
Analog output: Humidity control	Configuration ▶ Analog outputs ▶ Humidity control	Range output: <ul style="list-style-type: none"> ✓ 0...10 V ✓ 2...10 V ✓ 10...2 V ✓ 10...0 V 	
Digital output: Humidity control start	Configuration ▶ Digital outputs ▶ Humidity control start	<ul style="list-style-type: none"> ✓ NC (Normally closed) ✓ NO (Normally open) 	Dehumidification / Humidification

Feature	Menu path in Application tool	Variable	Note
Setpoints Humidity control	Ventilation ► Humidity control ► Humidity control	<ul style="list-style-type: none"> ✓ Setpoint humidity room/extract (%RH) ✓ Max limit humidity supply air (%RH) ✓ Neutral zone between humidification and dehumidification ✓ Max deviation room/extract air humidity (%RH) ✓ Digital output start/stop point (%RH) ✓ Hysteresis for max limit humidity supply air (%RH) 	
PID settings	Ventilation ► PID controllers ► Humidity	<ul style="list-style-type: none"> ✓ P-band (%RH) ✓ I-time (s) ✓ D-time (s) ✓ Max deviation room/extract air humidity (%RH) ✓ Digital output start/stop point (%RH) ✓ Hysteresis for max limit humidity supply air (%RH) P-band	

4.8.6 Required inputs and outputs for humidity control

Inputs and outputs	
AI	Room humidity sensor
AI	Duct humidity sensor
AI	Outdoor humidity sensor
AO	Humidity control output
DO	Humidity control start

4.9 Filter monitoring

Turn on filter monitoring in *Configuration ► Functions ► Function activation* .

Analog filter guards may be made air flow dependent. This means that a higher pressure drop is permitted across a filter at a higher air flow. For this purpose, X and Y coordinates are used to set the linear function that should be followed at a pressure drop alarm. They can also be accessed through the alarm settings in the display. FS = X1:0 m³/h, Y1:10 Pa : X2:2000 m³/h, Y2:150 Pa.

If a constant pressure drop alarm level is wanted, Y1 and Y2 should be set to the same value. In cases where flow control is not used, the first pressure value applies to pressure drop alarms (Y1).

4.9.1 Settings and configuration for filter monitoring

Feature	Menu path in Application tool	Variable	Note
Activate filter monitoring	Configuration ► Functions ► Function activation	Filter monitoring (yes/no)	
Type of filter monitoring	Configuration ► Functions ► Filter monitoring	<ul style="list-style-type: none"> ✓ Sensor ✓ Guard ✓ Sensor + Guard 	
Filter placement	Configuration ► Functions ► Filter monitoring	<ul style="list-style-type: none"> ✓ Supply air ✓ Extract air ✓ Supply air + Extract air 	

Feature	Menu path in Application tool	Variable	Note
Filter alarm reset	Configuration ► Functions ► Filter monitoring	Yes/No	
Filter alarm time (month)	Configuration ► Functions ► Filter monitoring	1...12	
Filter alarm supply air limit X1/ X2 (m³/h)	Configuration ► Functions ► Filter monitoring	Factory settings (FS): ✓ X1 = 0 ✓ X2 = 2000	
Filter alarm supply air limit Y1/ Y2 (Pa)	Configuration ► Functions ► Filter monitoring	Factory settings (FS): ✓ Y1 = 10 ✓ Y2 = 150	
Filter alarm extract air limit X1/ X2 (m³/h)	Configuration ► Functions ► Filter monitoring	Factory settings (FS): ✓ X1 = 0 ✓ X2 = 2000	
Filter alarm extract air limit Y1/ Y2 (Pa)	Configuration ► Functions ► Filter monitoring	Factory settings (FS): ✓ Y1 = 10 ✓ Y2 = 150	

Required inputs and outputs for filter monitoring

Inputs and outputs	Menu path in Application tool	Name	Settings
AI	Configuration ► Analog inputs	<ul style="list-style-type: none"> ✓ Pressure filter supply air ✓ Pressure filter extract air 	<ul style="list-style-type: none"> ✓ Device ✓ Terminal ✓ Name ✓ Sensor type ✓ Min input (V) ✓ Max input (V) ✓ Min signal (Pa) ✓ Max signal (Pa) ✓ Filter factor ✓ Mode ✓ Manual (°C)

4.10 Extended operation and External stop

The digital inputs for extended running can be used to force the unit to start in low, normal or high speed although the timer says the operation mode should be **Off**. This digital input has always higher priority than running via time schedule.

The unit will run for the set time. If the running time is set to 0 the unit will only run as long as the digital input is closed.

The signal *External stop* will stop the unit, even if the timer or one of the signals *Extended operation low speed*, *Extended operation normal speed* or *Extended operation high speed* says it should stay in running mode.

Table 4-64 Settings and configuration for extended operation and external stop

Feature	Menu path in Application tool	Variable	Note
Select extended operation	Configuration ► Functions ► Function activation	Extended operation (Yes/No)	
Select external stop	Configuration ► Functions ► Function activation	External stop (Yes/No)	
Select extended operation speed	Configuration ► Functions ► Extended operation	Extended operation low/normal/high speed (Yes/No)	

Table 4-64 Settings and configuration for extended operation and external stop (continued)

Feature	Menu path in Application tool	Variable	Note
Digital inputs: Extended operation low/normal/high speed	Configuration ► Digital inputs ► Extended operation low/normal/high speed	<ul style="list-style-type: none"> ✓ NC (Normally closed) ✓ NO (Normally open) 	
Digital input: External stop	Configuration ► Digital inputs	<ul style="list-style-type: none"> ✓ NC (Normally closed) ✓ NO (Normally open) 	

Table 4-65 Inputs and outputs Extended operation and external stop

Inputs and Outputs	
DI	Extended operation low speed
DI	Extended operation normal speed
DI	Extended operation high speed
DI	External stop

4.1.1 Time-switch outputs

Up to four digital time-switch outputs can be configured. Each time channel has a separate scheduler with four periods per week-day.

Extra time channel 4 can be used to control the function *Recirculation*, see 4.3.14 *Recirculation*

Table 4-66 Settings and configuration for time-switch outputs

Feature	Menu path in Application tool	Variable	Note
Select extra time channel	Configuration ► Functions ► Extra indications & functions	Extra time channel (0...4)	
Settings Time schedule	Time control ► Extra time channel 1...4		

Table 4-67 Inputs and outputs Time-switch outputs

Inputs and Outputs	Name	Settings	Menu path in Application tool
DO	Extra time channel 1	<ul style="list-style-type: none"> ✓ Controller/Expansion unit ✓ Terminal ✓ Name ✓ NC (Normally closed)/NO (Normally open) 	Configuration ► Digital outputs
DO	Extra time channel 2	<ul style="list-style-type: none"> ✓ Controller/Expansion unit ✓ Terminal ✓ Name ✓ NC (Normally closed)/NO (Normally open) 	Configuration ► Digital outputs
DO	Extra time channel 3	<ul style="list-style-type: none"> ✓ Controller/Expansion unit ✓ Terminal ✓ Name ✓ NC (Normally closed)/NO (Normally open) 	Configuration ► Digital outputs
DO	Extra time channel 4	<ul style="list-style-type: none"> ✓ Controller/Expansion unit ✓ Terminal ✓ Name ✓ NC (Normally closed)/NO (Normally open) 	Configuration ► Digital outputs

4.12 SFP, Specific Fan Power

When the frequency controlled fans are connected via Modbus and also supply information on motor output, the Corrigo is capable of calculating SFP using the following formula:

$$\text{SFP} = \text{Total effect from all fans} / \text{Supply air fan flow (in m}^3\text{/s)}$$

If both SAF and EAF flow transmitters are connected the controller uses the highest value. If only the SAF flow is connected that is used. If no flow sensor is connected it uses the highest calculated flow from the SAF pressure transmitter or EAF pressure transmitter.

Power loss as a percentage of the frequency converter can be added for calculating the total output. If, for instance, power loss is 5 %, the total output will be as follows:

$$\text{Total output} = (\text{Supply air fan output} + \text{Extract air fan output}) \times 1.05$$

A daily and a monthly average (always 30 days) are also computed and presented. SFP for the average values is calculated only when the unit is running

The SFP values are displayed in Ventilation ► Energy consumption ► SFP

4.13 Extra controller

An independent temperature control circuit for control of for example a separate zone. The circuit can be configured to heating or cooling. It has an analog input signal for temperature sensors and an analog output signal 0...10 V. There is also a digital output signal which is activated when the analog output signal is above 1 V and deactivated when the analog signal is below 0.1 V. The circuit can be configured to be active all the time or to be active only when the unit is running or when defrosting.

An alarm will be triggered if *Extra controller* is in manual position or if a sensor error occurs.

The extra controller can also be controlled by freeze protection.

Type of freeze protection: *Freeze protection temp 1-3*.

Table 4-68 Settings and configuration for Extra controller

Feature	Menu path in Application tool	Variable	Note
Select extra controller	Configuration ► Functions ► Function activation	Extra controller Yes / No	
Configuration Extra controller	Configuration ► Functions ► Extra controller	<ul style="list-style-type: none"> ✓ Start/Stop function ✓ Control mode ✓ Type of freeze protection ✓ Pump control ✓ Pump running mode ✓ Type of feedback ✓ Digital start output ✓ Extra contr. output when recirculation/support ✓ Sequence output min/max limit (%) 	
Analog inputs temperature extra controller	Configuration ► Analog inputs ► Extra controller temperature	<ul style="list-style-type: none"> ✓ Sensor type ✓ Min/max input (V) ✓ Min/Max signal (°C) ✓ Filter factor ✓ Compensation (°C) ✓ Mode ✓ Manual (°C) 	

Table 4-68 Settings and configuration for Extra controller (continued)

Feature	Menu path in Application tool	Variable	Note
Digital inputs	Configuration ► Digital inputs ► Feedback extra controller	<ul style="list-style-type: none"> ✓ NC (Normally closed) ✓ NO (Normally open) Manual / Auto 	
Analog outputs	Configuration ► Analog outputs ► Extra controller	Range output: <ul style="list-style-type: none"> ✓ 0...10 V ✓ 2...10 V ✓ 10...2 V ✓ 10...0 V 	
Digital outputs Extra controller start / Extra controller pump	Configuration ► Digital outputs ► Extra controller start / Extra controller pump	<ul style="list-style-type: none"> ✓ NC (Normally closed) ✓ NO (Normally open) 	
Setpoint extra controller	Additional function ► Extra controller ► Actual/Setpoint	Setpoint extra controller (°C)	
Temperature control	Additional function ► Extra controller ► Temperature control	<ul style="list-style-type: none"> ✓ Digital start output start/stop point (%) ✓ Pump stop delay (min) ✓ Pump-kick hour (h) ✓ Pump running when outdoor temperature < (°C) ✓ Hysteresis to allow pump stop (°C) 	
PID settings	Additional function ► Extra controller ► PID controller	<ul style="list-style-type: none"> ✓ P-band (°C) ✓ I-time (s) ✓ D-time (s) 	
Manual / Auto	Additional function ► Extra controller ► Manual / Auto	<ul style="list-style-type: none"> ✓ Controller mode ✓ Manual set (%) ✓ Controller output (%) ✓ Extra controller start mode ✓ Start ✓ Extra controller pump mode ✓ Start 	

4.14 Room unit

A room unit, ED-RU_x, can be configured in the *Functions* menu in Application tool.

Room units are available with or without display, or as a touch display (see instructions and product sheets for ED-RU... and ED-RUD-2).

Different functions are available depending on the selected room unit, such as:

- ✓ Setpoint adjustment
- ✓ Show temperature
- ✓ Extended operation
- ✓ Select the speed of the fan

Feature	Menu path in Application tool	Variable	Note
Temperature to show in ED-RUx	Configuration ► Functions ► Room unit	Temperature to show in ED-RUx: ✓ Room temperature of the display ✓ Room temperature from sensor connected to controller ✓ Outdoor temperature ✓ Supply air temperature ✓ Extract air temperature	
Function on/off button	Configuration ► Functions ► Room unit	Function on/off button: ✓ No function ✓ On/Off function ✓ On/Off/Extended operation function	
Fan speed extended run	Configuration ► Functions ► Room unit	Fan speed extended run: ✓ Low speed extended run ✓ Normal speed extended run ✓ High speed extended run	
Extended operation	Configuration ► Functions ► Room unit		minutes
Max negative setpoint adjustment	Configuration ► Functions ► Room unit		
Max positive setpoint adjustment	Configuration ► Functions ► Room unit		

4.15 Energy consumption

If the fans are controlled with Modbus communication, it is possible to follow up the energy consumption in Application tool and in the web interface..

In the menu *Ventilation ► Energy consumption* you find the following information:

- ✓ SFP (Specific Fan Power)
- ✓ Power usage fans - the sum of power for all configured fans (SAF or EAF)
- ✓ Today and last 7 days - total accumulated power usage for today and the last seven days.
- ✓ This year - total accumulated power usage for the current year and for each month separately.
- ✓ Last year - total accumulated power usage for the previous year and for each month separately.

5 Information for the specialist - Configuration

5.1 Configuration of the Corrigo

The configuration of the Corrigo is made in Application tool, a free PC-based software available on www.regincontrols.com

The controller doesn't need to be connected to the computer while configuring. All settings are made in the tool and then uploaded to the controller.

An infinite number of configurations can be stored in the computer memory for later use.

A communication cable is required in order to upload the configuration to the controller. The controller must also be powered up and the application selected in order for it to be configured.

5.1.1 Predefined configurations for Corrigo

There are predefined configurations available for easy configuration. They can be selected in the internal text display, in the web interface or can be downloaded as atf-files on Regin's webpage. The atf-files can be used in Application tool for further offline modification and adaption.

The predefined configurations are a part of Regin's Ready-Steady-Go concept which makes it much easier and faster to configure the controller.

Predefined configurations in internal text display

Use the internal text display in the Corrigo to select a predefined configuration.

1. Start from the start menu.

```
Vent controller 5.0
2020-01-08 14:29
System: Normal run
Sp:22.0 Act: 22.5°C
```

2. Press the right button **[▶]** 7 times until you reach the menu to select the configuration.

```
Choose Config File
None
```

3. Select the configuration you want. Available configurations depend on the number of IOs in the hardware.

4. Select add-ons. Available add-ons depends on the used hardware and selected configuration.

CO2 fan add-on No
CO2 damper add-on No
Extended run add-on No
Fire alarm add-on No
Free cooling add-on No

5. Activate the configuration

Load configuration No

Predefined configurations in web interface

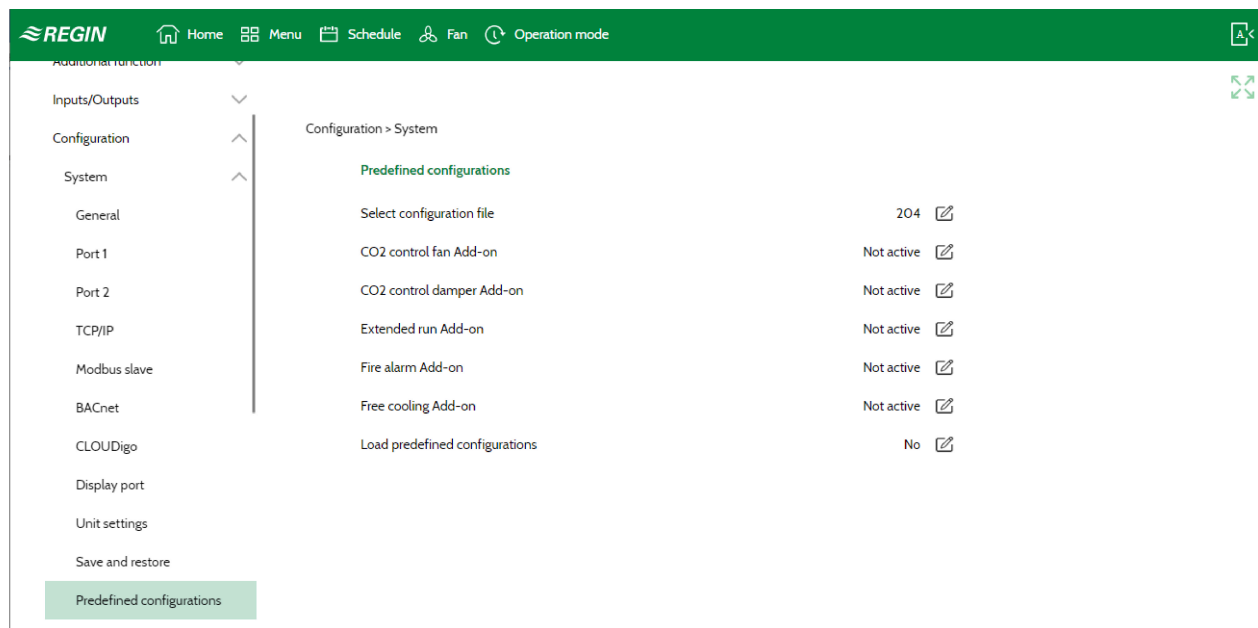

Figure 5-1 Predefined configuration in web interface

Predefined configurations as atf-files

Predefined configurations can be downloaded as atf-files from Regin's website (www.regincontrols.com). The atf-files can be opened in Application tool and synchronized to the controller.

5.1.2 Application tool

Application tool is used both to configure, monitor and make changes in the application. The start screen gives an overview about what functions are available. For a description of the functions, see table 5-1 below. For configuration and ventilation settings see *chapter 5.5 Configuration - Functions* and *chapter 5.8 Ventilation*.

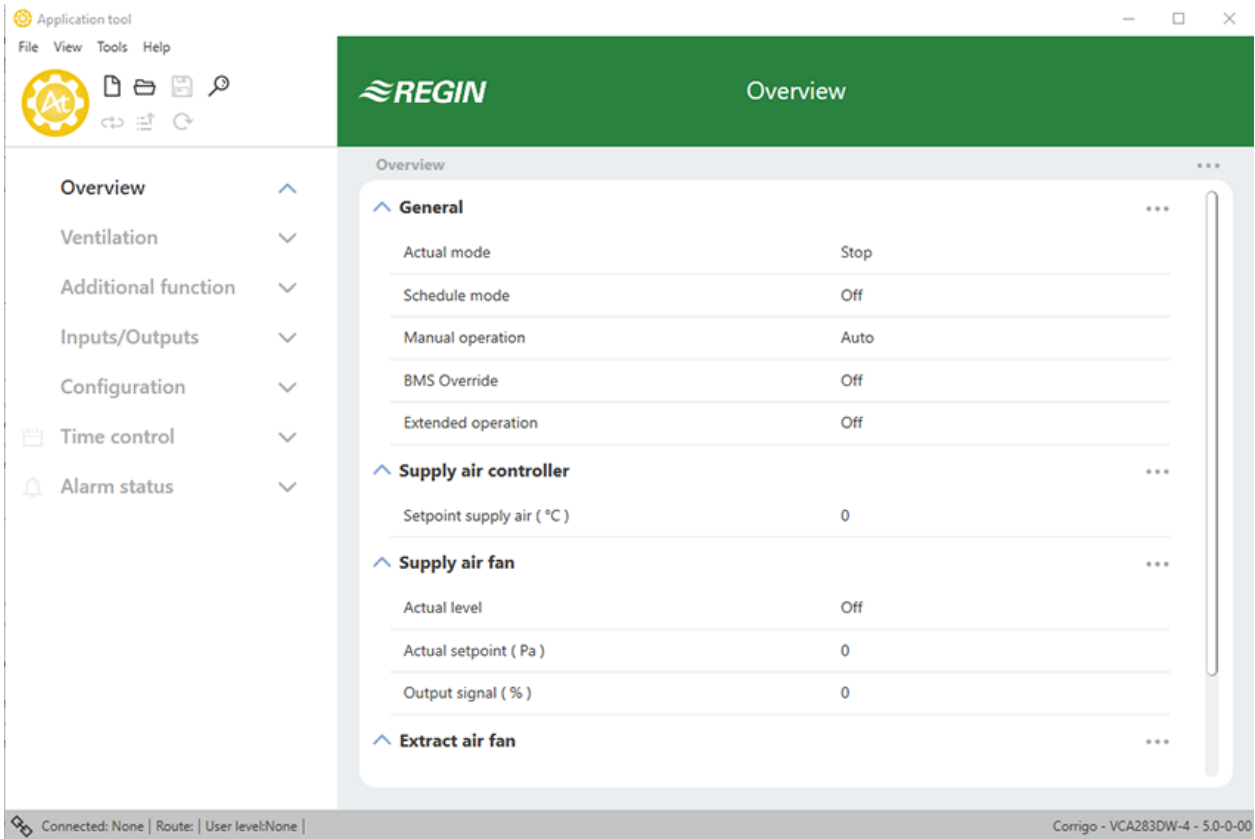

Figure 5-2 Application tool start screen

Table 5-1 Application tool: Menu items

Overview	An overview of the functions and values in the application
Ventilation	Configure setpoints, temperatures etc. Monitoring of ventilation unit.
Additional function	Configuration of an extra controller.
Inputs/Outputs	Read values from all inputs and outputs.
Configuration	Configuration of the BAS (Building Automation System). Switch on and off functions, define sequences etc.
Time control	Configure when the system should be working. Also possible in the display and in the web interface.
Alarm status	Check and acknowledge the alarms in the application.

5.2 Work flow for configuration and commissioning the Corrigo

1. Start by configuring the controller in Application tool or in the web interface. Both user-interfaces can be used to configure the controller in the same way. All following information is based on Application tool, but also applies to the web interface. Go through all the steps under the **Configuration** menu, see table 5-2 below.



Note! All menus in Application tool are adaptive, which means that they adapt to the function/application you choose to set up. Therefore, not all menu items are available for all applications.

Table 5-2 Configuration menu in Application tool

Configuration menu item	Description
System	General settings, Communication settings, Unit settings, Save and restore settings
Device list	Activation of the different devices in the BAS (Building Automation System)
Functions	Activation of functions in the BAS. Configuration of sequences A to J
Analog inputs	Configuration of Analog inputs
Digital inputs	Configuration of Digital inputs
Analog outputs	Configuration of Analog outputs
Digital outputs	Configuration of Digital outputs
Raw values	Read raw values from the controller and expansion units

2. Go to **Ventilation** menu in Application tool after the configuration is done. In the Ventilation menu you will set values and parameters for the application, see table below.

Table 5-3 Ventilation menu in Application tool

Ventilation menu item	Description
Actual/Setpoint	Read the actual values and setpoints from the controller. Change setpoints.
Temperature control	Setting of parameters and values for Sequence A to J, Step controllers, Freeze protection, Exchanger, Pretreatment and Summer mode
Fan control	Setting of values for fans and compensation curves
Demand control	Setting of values for CO ₂ , Recirculation, Free cooling and Support control
Fire/Smoke	Setting of values for Fire and Smoke dampers and alarms
Humidity control	Setting of values for humidity control
PID controllers	Setting of P, I and D- values for Room, Extract air, Sequence A to J, Supply air fan, Extract air fan, CO ₂ , Freeze protection, Defrosting and Humidity
Energy consumption	Read information about SFP, power usage for fans and accumulated power usage for today, last 7 days, current and previous year.
Manual/Auto	Setting of Manual or Auto control of units, functions and sequences.
Status	Read status for the Ventilation unit and Sequences A to J

3. Load the application into the controller and commission. The application can be loaded from the web interface or Application tool.

In Application tool, go to the *Tools* menu at the top and select *Load program*.



Note! The controller and the computer need to be in the same network.

5.3 Configuration - System

Start with configuration of the system which contains the configuration of:

- ✓ General settings
- ✓ Communication settings
 - ✓ Serial Ports
 - ✓ BACnet
 - ✓ TCP/IP
- ✓ Display port
- ✓ Unit settings
- ✓ CLOUDigo
- ✓ Save and restore

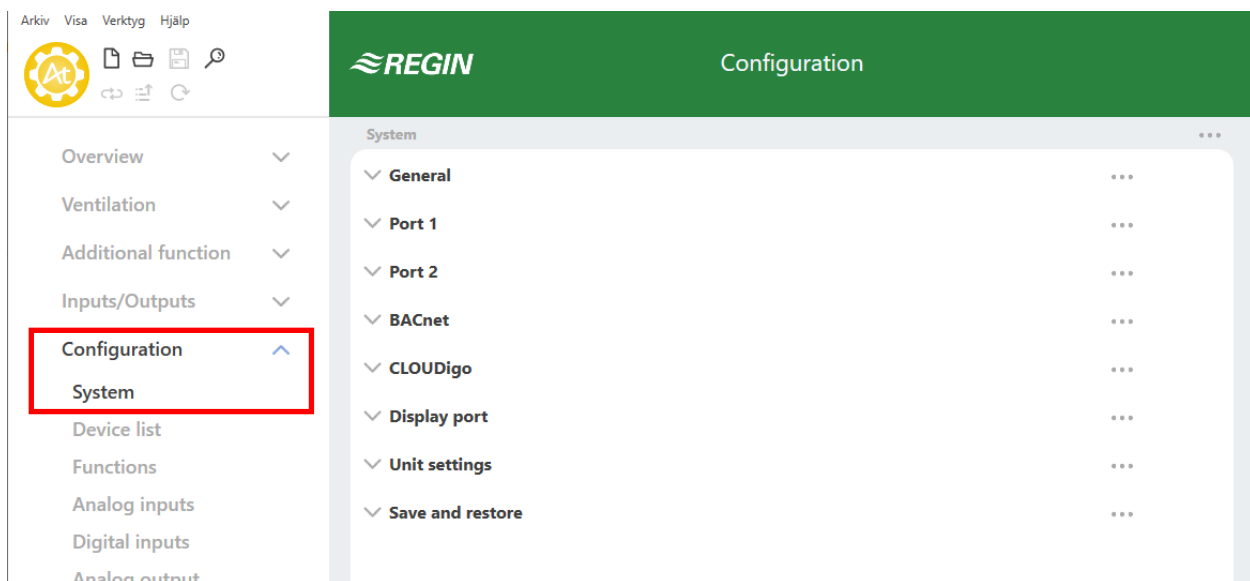

Figure 5-3 System configuration in Application tool

5.3.1 General settings

Under *General* is information about the controller, and some general settings can be made.

Change language

The display language can be changed either by the front display, in the web interface or in Application tool.

Front display menu:

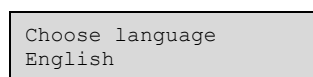

Note! This menu is also accessible by holding the [OK] button pressed during power-up or by pressing the [▶] button four times when the start display is shown.

Web interface:

Account settings ▶ Language

Application tool:

Configuration ▶ System ▶ General ▶ Language

Start screen

There are several different start screens to choose from. The start screen can be changed in Application tool at: *Configuration ▶ System ▶ General*

Type 1, Show headline, date/time, vent. mode, supply temp / setp.

```
Vent controller 5.0  
2019-08-01 11:28  
System: Normal speed  
Sp: 32.8°C Act:33.1°C
```

Second line: Date and time

Third line: Status of the unit

Fourth line: Supply temperature and setpoint

Type 2, Show headline, vent. mode, supply temp / setp, sequence A to C

```
Vent controller 5.0  
System: Normal speed  
Sp: 32.8°C Act:33.1°C  
A 100 B 100 C 100
```

Second line: Status of the unit

Third line: Supply temperature and setpoint

Fourth line: Output signal of the sequences A to C

Type 3, Show headline, vent. mode, supply temp / setp, SAF / EAF pressure

```
Vent controller 5.0  
System: Normal speed  
Sp: 32.8°C Act:33.1°C  
SAF: 2000 EAF: 2000
```

Second line: Status of the unit

Third line: Supply temperature and setpoint

Fourth line: SAF- and EAF- pressure

Type 4, Show headline, date/time, vent. mode

```
Vent controller 5.0  
2019-08-01 11:28  
System: Normal speed
```

Second line: Date and time

Third line: Status of the unit

Type 5, Show headline, date/time

```
Vent controller 5.0
2019-08-01 11:28
```

Second line: Date and time

Automatic switch between summer and winter time adjustment

The internal clock is normally configured for automatic summer / winter time adjustment. When enabled, the clock will be set forward one hour at 02:00 am on the last Sunday of March and adjusted back one hour at 03:00 am on the last Sunday of October.

The function can be disabled in Application tool: *Configuration* ▶ *System* ▶ *General*

Automatic logoff

If the access level is set to **Operator** or **Admin**, the user will automatically be logged off after a set time of inactivity. The time is settable in units of 5 seconds in Application tool. The default is 60 units = 5 minutes

The automatic log off can be disabled in Application tool: *Configuration* ▶ *System* ▶ *General* ▶ *Time before automatic logoff in display (unit 5s) (min)*

5.3.2 Port 1 and Port 2

The controller can have one or two serial ports. In a controller with two serial ports, both ports have the same functions. However, they can not both be configured to have the same function at the same time, except that both can be slaves.

Table 5-4 Available settings for Port configuration

Types of communication	Available formats	Available Baud rates
✓ EXOline slave (Default)	✓ 8N1 – 8 bit, no parity, 1 stop bit	✓ 9600 (Default)
✓ EXOline master	✓ 8E1 – 8 bit, even parity, 1 stop bit	✓ 14400
✓ Modbus slave	✓ 8O1 – 8 bit, odd parity, 1 stop bit	✓ 19200
✓ Modbus master	(Default)	✓ 28800
✓ BACnet MSTP slave	✓ 8N2 – 8 bit, no parity, 2 stop bit	✓ 38400
✓ EFX master	✓ 8E2 – 8 bit, even parity, 2 stop bit	✓ 57600
	✓ 8O2 – 8 bit, odd parity, 2 stop bit	✓ 76800
		✓ 115200

The default settings of the ports is EXOline slave:

```
Function port1
EXOline slave
Format 801
Baud 9k6
```

Table 5-5 Port 1 and 2: Function default values

Function	Connection to	Format	Baud
EXOline slave	Application tool or SCADA system	801	9600
EXOline master	Pressure transmitters, Expansion units or Room units	801	9600
Modbus slave	SCADA system via Modbus or master controller	8N1	9600

Table 5-5 Port 1 and 2: Function default values (continued)

Function	Connection to	Format	Baud
Modbus master	Fans, Rotary exchanger, Pressure transmitters, Damper actuators and Wireless receivers	8N1	9600
BACnet MS/TP slave	BACnet SCADA or BACnet master controller	8O1	9600

5.3.3 Modbus slave

Set the Modbus address for the Modbus slave.

5.3.4 BACnet

The controller is capable of communication via the BACnet -protocol, using either IP or MS/TP data link formats.

In order to connect a controller to a BAS (Building Automation System) via BACnet/IP, a controller with a TCP/IP port is required. To connect to a BAS via BACnet MS/TP, a controller with an RS485 communication port is required.



Note! All menus in Application tool are adaptive, which means that they adapt to the function/application you choose to set up. Therefore, not all menu items are available for all applications.

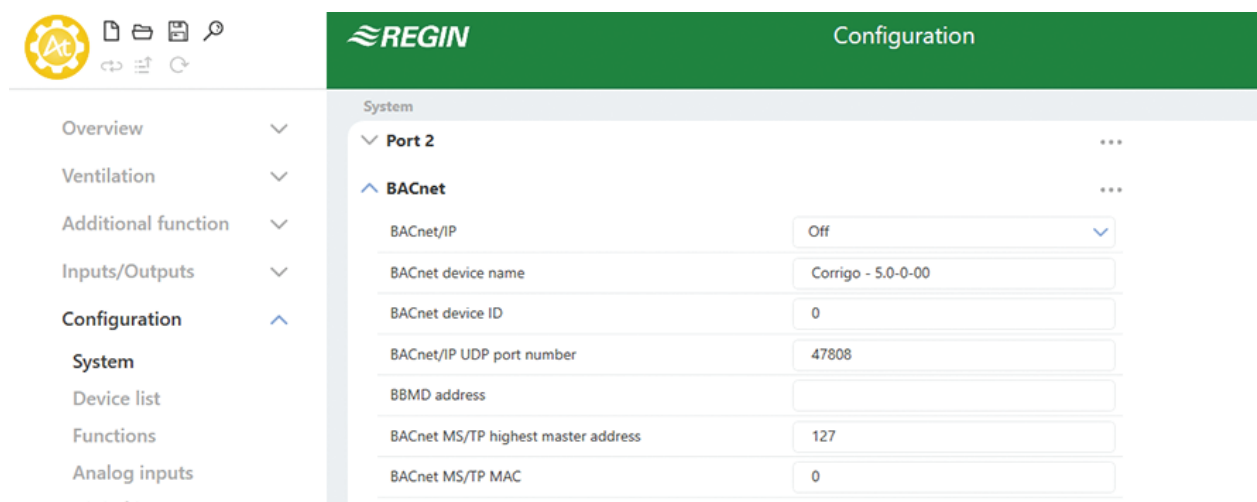

Figure 5-4 All BACnet settings

Table 5-6 BACnet settings

Variable	Function	Description
BACnet/IP	On/Off	The BACnet/IP protocol is disabled as default. Choose On to enable the protocol.
BACnet device name	Name of the controller	Editable
BACnet device ID	The ID of a device, used to identify it on the BACnet network	The ID number must be unique, and can not be duplicated anywhere on the BACnet network. Editable.
BACnet/IP UDP port number	47808	

Table 5-6 BACnet settings (continued)

Variable	Function	Description
BBMD address	The address is entered as host:port , where host can be the host's name if DNS is configured. If DNS is not configured, the host address should be entered in the format xxx.xxx.xxx.xxx , followed by the port number (default setting 47808). Example: mybbmd: 47808 (with DNS configured) or 10.100.50.99:47808	The BBMD address (BACnet/IP Broadcast Management Device) is used for discovering devices that are attached to different BACnet/IP subnets and separated by an IP-router. Editable.
BACnet MS/TP highest master address	127	The max master address is the MAC address of the highest master device on the BACnet MS/TP network segment. Setting this number above the highest MAC address will decrease network performance. Editable.
BACnet MS/TP MAC	0	The MAC address of the device. This needs to be unique only to the subnet to which the device is attached. Editable.

5.3.5 CLOUDigo

The Corrigo can be connected to Regin's cloud server CLOUDigo for access to the controller from any computer.

Set *Active* to **On** to be able to connect to CLOUDigo.

Read more about CLOUDigo at Regin's webpage, www.regincontrols.com.

5.3.6 Display port

Two different external displays can be used with the Corrigo.



Note! To change from E3-DSP as external display to the ED-T43L-V you need to disconnect the controller from power and connect it again.

Display	Description
E3-DSP	External text display with menu buttons.
ED-T43L-V	External touch display. 4.3 inch.

Both displays can be found on www.regincontrols.com

5.3.7 Unit settings

Choose units for the system.

Function	Unit
Temperature	°C or °F
Flow	m ³ /h, CFM, m ³ /s or l/s
Pressure	Pa or in.wg

5.3.8 Save and restore

It is possible to save all settings in a separate memory area of the controller and restore it afterwards. Two different settings can be stored; local settings and factory settings. The saved settings are available after a reset of the application, see *chapter 6.3 Loading the application*.



Note! A reload of the application to the controller will delete the saved settings.

Variable	Function	Description
Save settings local	Yes/No	Saving of the current configuration as local "user" settings
Restore settings to local	Yes/No	Restore the saved settings.
Save factory settings	Yes/No	Saving the current configuration as factory settings
Total restore to factory settings	Yes/No	Go back to the factory settings the controller was delivered with.

5.3.9 Controller address (PLA : ELA)

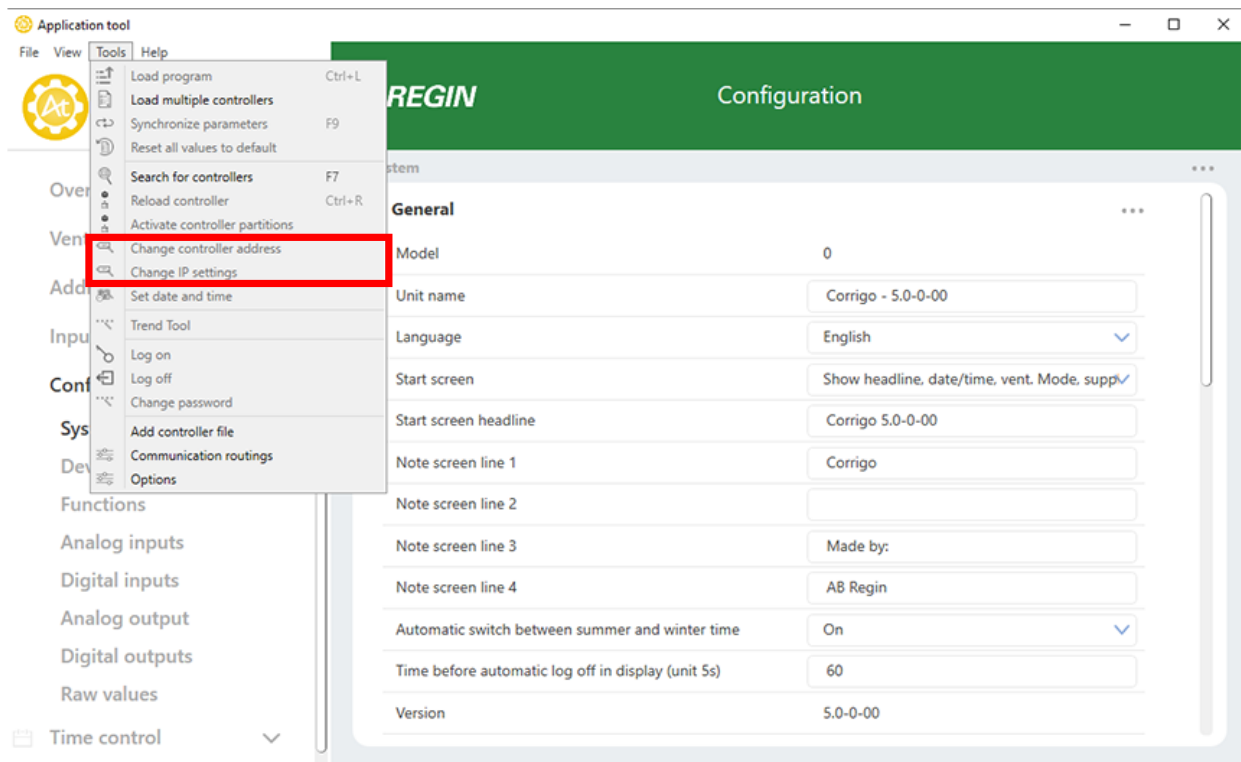

Figure 5-5 Changing the controller address and IP settings

The controller uses PLA:ELA addresses when connecting to Application tool and when multiple controllers are connected in a network. Application tool normally uses the addresses PLA = 254 and ELA = 254, so if an address is changed, the new address must also be entered in Application tool. If several controllers are connected in a network, all the units must have the same PLA address, but each unit must have a unique ELA address.

The address can be changed in the Application tool in the menu Tools ► Change controller address, see *Figure 5-5 Changing the controller address and IP settings* above.

5.3.10 IP-configuration

IP configuration can be made both in Application tool or in the built-in display.

The *Dynamic Host Configuration Protocol* (DHCP) is a network protocol used on *Internet Protocol* (IP) networks for dynamic distribution of network configuration parameters, such as IP addresses, DNS servers and other services.

The controller can be configured to either obtain an IP address from a DHCP server (dynamic) or the address can be set manually (static).

Three additional functions can be activated on the network interface:

- ✓ BACnet IP communication
- ✓ Connection to the Cloud-server
- ✓ Modbus TCP

If you wish to set a static IP address for the controller, enter the IP address you wish to use along with the subnet mask, gateway address and DNS server address. In Application tool you go to the *Tools* menu and choose *Change IP settings*, see figure *Figure 5-5 Changing the controller address and IP settings* above.

In the display you do as follows below:

```
TCP/IP
```

```
DHCP: Yes
Set static IP
Running IP
-
```

```
IP
192.168.001.234
Subnet mask
255.255.255.000
```

```
Running subnet mask
-
Running gateway
-
```

```
Running DNS1
192.168.001.001
Running DNS2
192.168.001.001
```

5.4 Configuration - Device list

Different kind of devices can be connected to the Corrigo, i.e. transmitters, fans/frequency converters and expansion units.

It is possible to change the name of the Device in the *Name* field

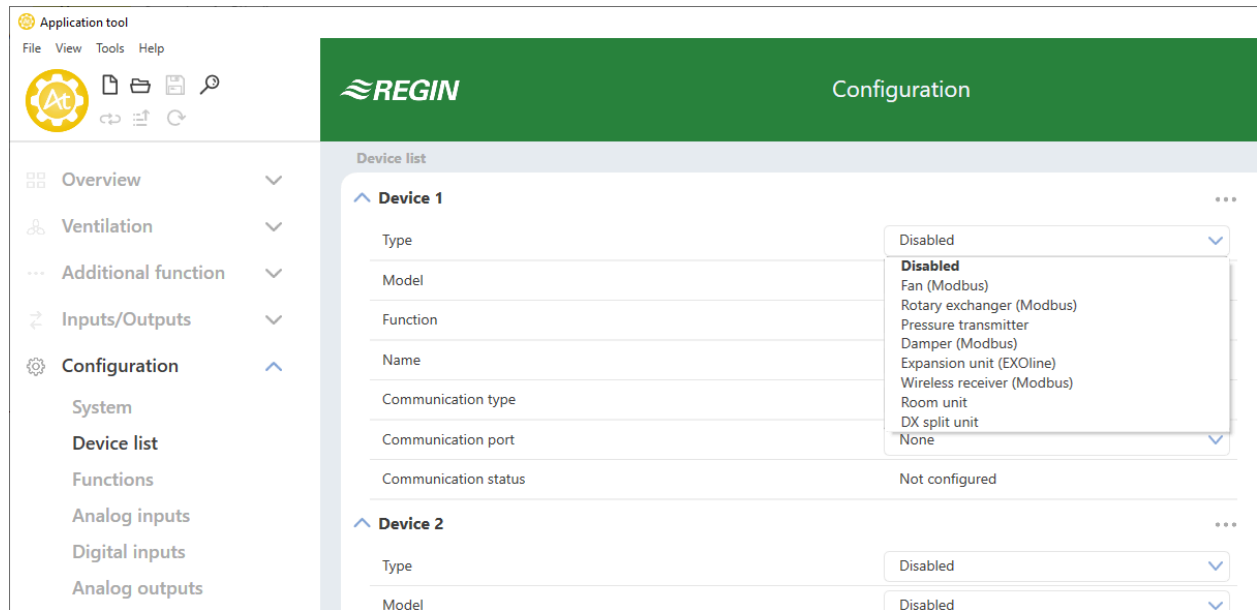

Figure 5-6 Device list

5.4.1 Fan (Modbus)

The Corrigo only supports frequency controlled fans with Modbus communication. The fan can be set to three different speeds: *Low*, *Normal* and *High*.

Table 5-7 Fan models and configuration

Model	Function	Name
<ul style="list-style-type: none"> ✓ Vacon ✓ Lenze ✓ Yaskawa/Omron ✓ Emerson ✓ LS iG5A ✓ LS iS7 ✓ EBM - PAPST ✓ DANFOSS FC101 ✓ ABB ACSxxx ✓ Ziehl EC Blue 	<ul style="list-style-type: none"> ✓ Disabled ✓ Supply air fan ✓ Extract air fan 	Optional: name the fan

5.4.2 Rotary exchanger (Modbus)

A rotary heat exchanger can be connected to the controller. Three different models can be used.

Table 5-8 Rotary exchanger models and configuration

Model	Function	Name
<ul style="list-style-type: none"> ✓ RHC 200 (Reflex- Winkelmann) ✓ VariMax25M (IBC control) ✓ OJ DRHX 	Sequence A to J	Optional: Name the rotary exchanger

5.4.3 Pressure transmitter (Modbus / EXoline)

Regin's differential pressure transmitter Presigo can be connected to the controller. Two generations of Presigo are available (PDT... and PTDX) and they are available with one or two pressure sensors. Presigo can

be configured as expansion unit (1...10) (under *Configuration* ▶ *Device list* ▶ *Device x* ▶ *Function*) and will expand the number of available I/O:s.

Presigo model	Generation	Pressure sensors	Communication	Expansion with I/O:s
PDT...C	1	1	Modbus	2 x UI
PDT...C-2	1	2	Modbus	2 x UI
PDT...C	1	1	EXOline	2 x UI
PDT...C-2	1	2	EXOline	2 x UI
PDTX...	2	1	Modbus	2 x UI, 2 x UO
PDTX...-2	2	2	Modbus	2 x UI, 2 x UO

When used together with Corrigo, PDT...C(-2) should use the following EXOline address:

Table 5-9

Expansion unit in Corrigo	PLA	ELA
3	242	1
4	242	2
5	242	3
6	242	4

PDT...C-2 models (models with two pressure sensors) can only be used as expansion unit 3 and 4 and PDT...C models (models with one pressure sensor) can only be used as expansion 5 and 6.

5.4.4 Damper actuator

The controller supports three different kinds of damper actuators

Table 5-10 Damper models and configuration

Model	Function	Name
<ul style="list-style-type: none"> ✓ Regin ✓ Belimo Brand ✓ Siemens 	<ul style="list-style-type: none"> ✓ Sequence A to Sequence J ✓ Recirculation air damper ✓ Outdoor air damper ✓ Exhaust air damper ✓ Fire damper 	Optional: Name the damper actuator

5.4.5 Expansion unit (EXOline)

In order to connect additional inputs and outputs to the controller, a communication device needs to be configured. It is possible to connect two expansion units, giving a maximum number of $28 \times 3 = 84$ inputs/outputs. I/O-expansion units or controllers configured as expansion units can be connected.



Note! The expansion units must have the addresses 241:1 and 241:2 respectively (PLA:ELA).

Expansion unit	Number of I/O:s
IO-A15MIXW-3-BEM	15 I/O:s
IO-A28MIXW-3-BEM	28 I/O:s
IO-V19MIXW-1-BEM	19 I/O:s

5.4.6 Wireless receiver (Modbus)

To be able to use wireless transmitters and sensors in the installation, a wireless receiver must be connected to the Corrigo. There are two receivers available, with different numbers of sensors that can be connected.

Wireless Receiver	Number of sensors
RCW-M	16
RCW-M32	32

No further settings are necessary to communicate with the wireless receiver.

5.4.7 Room unit (EXOline/Modbus)

The temperature, fan speed and CO₂-level in a room can be controlled via a room unit connected to the Corrigo. There are nine different room units to choose from with different features (see table below).

The room units communicate via EXOline and are connected to the serial ports.

In Application tool, they are configured as expansion units 1...10.

Article	Occu-pancy button	3-step fan control	Built-in CO ₂ sensor	Setpoint knob	Multi-function button	Hidden setpoint	Display	EXOline (E)/ Modbus (M)
ED-RU	-	-	-	✓	-	-	-	E
ED-RU-O	✓	-	-	✓	-	-	-	E
ED-RU-F	-	✓	-	✓	-	-	-	E
ED-RU-FO	✓	✓	-	✓	-	-	-	E
ED-RU-DO	✓	-	-	-	-	-	✓	E
ED-RU-DFO	✓	✓	-	-	-	-	✓	E
ED-RU-DOS	✓	-	-	-	✓	-	✓	E
ED-RU-H	-	-	-	-	-	✓	-	E
ED-RU-DOCS	✓	✓	✓	-	-	-	✓	E
ED-RUD-2	✓	✓	-	-	✓	-	✓	M

5.4.8 DX split unit

The temperature of the supply air can be controlled via a DX split unit connected to the Corrigo. There is one device providing DX split features (see table below).

The DX split unit communicates via Modbus and is connected to the serial ports.

In Application tool, it is configured as Changeover 1 or Changeover 2.

Article	Function
Mitsubishi Heavy	Changeover 1/2

5.5 Configuration - Functions

This is where you activate the functions that will be used in the BAS (Building Automation System). It is also where you set up sequence A to J. All functions are more thoroughly described in chapter 4 *Information for the specialist - Function descriptions*.



Note! All menus in Application tool are adaptive, which means that they adapt to the function/application you choose to set up. Therefore, not all menu items are available for all applications.

5.5.1 Function activation

In this section you choose control types and turn on or off functions in the BAS (Building Automation System).

Temperature control type

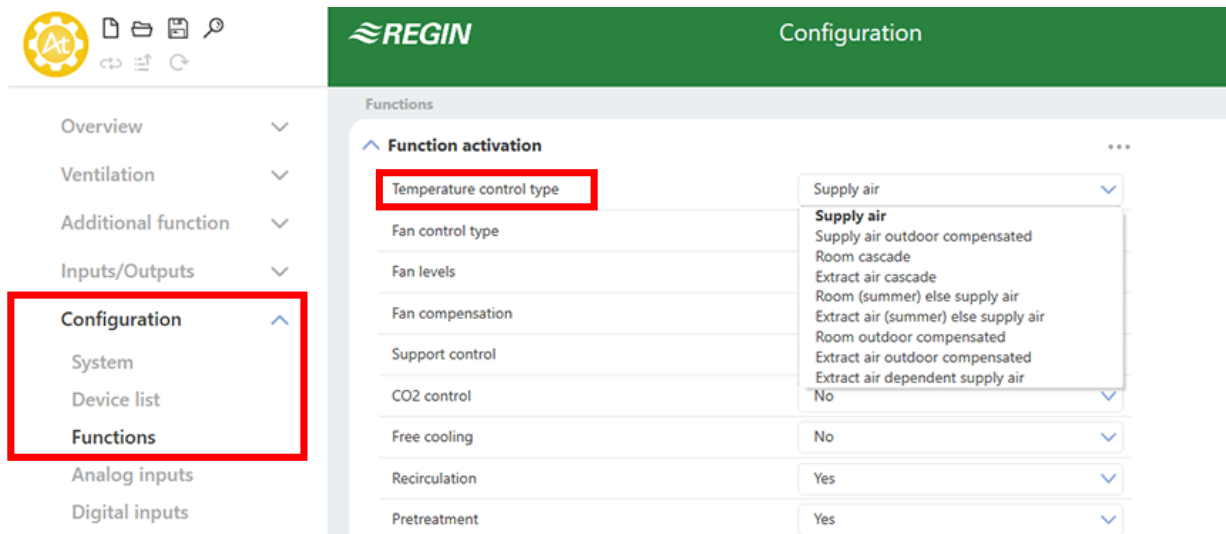

Figure 5-7 Temperature control type

Table 5-1 | Temperature control types

Application	Description	More information
Supply air	The supply air controller output is either a heating demand or a cooling demand depending on if the supply temperature is over or under the setpoint. This demand is then divided into up to 10 sequences, A to J. Each sequence can be configured as heat, cool, exchanger, damper, compensation or not used and each sequence has its own PID-settings.	Function description: <i>chapter Supply air control</i> Sequences: <i>chapter 4.3 Temperature sequences</i>
Supply air outdoor compensated	The supply air temperature setpoint is temperature compensated using a control curve. The temperature for compensation is configurable between all temperature sensors. The supply air temperature is kept at the setpoint value by controlling the output signals for sequence A to J.	Function description: <i>chapter Supply air outdoor compensated</i> Sequences: <i>chapter 4.3 Temperature sequences</i>
Room cascade	Cascade control of room temperature and supply air temperature to achieve a constant, settable room temperature. The room temperature is kept at the setpoint value by controlling the output signals for sequence A to J.	Function description: <i>chapter Room cascade</i> Sequences: <i>chapter 4.3 Temperature sequences</i>

Table 5-11 Temperature control types (continued)

Application	Description	More information
Extract air cascade	Cascade control of extract air temperature and supply air temperature to achieve a constant, settable room temperature. The extract air temperature is kept at the setpoint value by controlling the output signals for sequence A to J.	Function description: <i>chapter Extract air cascade</i> Sequences: <i>chapter 4.3 Temperature sequences</i>
Room (summer) else supply air	Summer mode dependent switching between supply air temperature control and room temperature control. When the summer mode function is off, temperature compensated supply air temperature control will be active, otherwise (in summer) cascaded room temperature control. Summer mode function is used for switching control mode.	Function description: <i>chapter Room (summer) else supply air outdoor compensated</i>
Extract air (summer) else supply air	Summer mode dependent switching between supply air temperature control and extract air temperature control. When the summer mode function is off, temperature compensated supply air temperature control will be active, otherwise (in summer) cascaded extract temperature control. Summer mode function is used for switching control mode.	Function description: <i>chapter Extract air (summer) else supply air outdoor compensated</i>
Room outdoor compensated	The extract air temperature can be compensated when the outdoor temperature increases.	Function description: <i>chapter Room outdoor compensated</i>
Extract air outdoor compensated	A difference between extract air temperature and supply air temperature can be configured to maintain that the supply air temperature setpoint follows the extract air temperature.	Function description: <i>chapter Extract air outdoor compensated</i>
Extract air dependent supply air	A difference between extract air temperature and supply air temperature can be configured to maintain the supply air temperature setpoint to follow extract air temperature.	Function description: <i>chapter Extract air dependent supply air</i>

Read more about the temperature control functions in *4.2 Temperature control*.

Fan control type

Table 5-12 Fan control types

Application	Description	More information
Pressure	Control of the fan speed using pressure transmitters.	Function description: <i>chapter Pressure</i>
Flow	Instead of giving a pressure setpoint value, it is possible to use an airflow volume value in m ³ /h. The value from the pressure transmitter is recalculated to a volume flow and the fans will be controlled to give a constant flow.	Function description: <i>chapter Flow</i>
Manual	Use the manual setting if you want to manually set the speed of the fan	Function description: <i>chapter Manual</i>
External	Use the external setting if you have an external device that controls the fan speed, e.g. a 0...10 V device.	Function description: <i>chapter External</i>

Table 5-12 Fan control types (continued)

Application	Description	More information
Supply air pressure and extract air fan slave	The speed of the supply air fan is controlled by a pressure transmitter which is placed in the supply air duct. The extract air fan does not have a pressure transmitter, instead you let the output for the extract air fan follow the control signal for the supply air fan. A scaling factor can be added if the characteristics of the extract air fan are not the same as the characteristics of the supply air fan. (Only pressure control of the supply air fan is possible using this function.)	Function description: <i>chapter Supply air pressure and extract air fan slave</i>
Supply air pressure with extract air flow slave	The speed of the supply air fan is controlled by a pressure transmitter which is placed in the supply air duct. The extract air fan is controlled by the supply air flow, in order to achieve a balanced ventilation. A pressure transmitter which is placed in the supply air fan cone (SAF flow) gives a measured value of the present supply air flow. A corresponding pressure transmitter is placed in the extract air fan cone and gives a measured value of the extract air flow. The supply air flow is the setpoint used for control of the extract air fan. A scaling factor can be added if the extract air fan does not have the same characteristics as the supply air fan.	Function description: <i>chapter Supply air pressure with extract air flow slave</i>
Extract air pressure with supply air fan slave	The speed of the extract air fan is controlled by a pressure transmitter which is placed in the extract air duct. The supply air fan has no pressure transmitter. Instead, the supply air fan output is made to follow the extract air fan control signal. A scaling factor can be added if the supply air fan characteristics are not the same as the characteristics of the extract air fan (only pressure control of the extract air fan is possible using this function).	Function description: <i>chapter Extract air pressure with supply air fan slave</i>
Extract air fan pressure with supply air flow slave	The speed of the extract air fan is controlled by a pressure transmitter which is placed in the extract air duct. The supply air fan is controlled by the extract air duct flow in order to achieve a balanced ventilation. A pressure transmitter placed in the extract air fan cone (EAF flow) provides a measurement of the current extract air flow. A corresponding pressure transmitter is placed in the supply air fan cone, providing a measurement of the supply air flow. The supply air fan is controlled using the extract air flow as a setpoint. A scaling factor can be added if the supply air fan does not have the same characteristics as the extract air fan.	Function description: <i>chapter Extract air fan pressure with supply air flow slave</i>

Read more about fan control types in *4.4 Fan control*

Fan levels

A frequency controlled fan is the only type of fan that works with the Corrigo. The fan can be set to *Low*, *Normal* or *High* speed. The selection of the fan speed defines which IOs and time channels will be active in the application.

The fans will always start directly with the desired speed.

There are four different fan speed levels to choose from in Application tool:

- ✓ Normal
- ✓ Low - Normal

- ✓ Normal - High
- ✓ Low - Normal- High

Variable speed control uses an analogue output per fan or Modbus communication for controlling a frequency converter.

For more information about frequency converters, see *Appendix F Frequency converters and EC controllers for heat exchangers*

The fans are normally controlled by the timer channels for slow, normal and high speed but can also be started via digital input or communication.

The extract air fan and the supply air fan have individual start and stop delays which are normally set so that the extract air fan is started before the supply air fan. If there are not enough digital outputs for individual control, both fans will have to be started using the signal for the supply air fan, and the delay will be created using an external time relay.

Fan compensation

When running pressure/flow control or manual frequency control, it is also possible to for the pressure/flow or output to be temperature compensated.

This compensation can be made depending on any analogue input such as supply air, extract air, room, outdoor temperature, humidity, CO₂ and so on. There are three equal compensation functions available.

It is possible to compensate either one or both of the fans at the same time and it is possible to set which fan should then be compensated, the supply fan or the extract air fan.

Read more about fan compensation in *chapter Compensation curve*

Support control

Support control is normally used when room temperature control or extract air control has been configured. When extract air control is configured a room sensor must be installed.

Support control can also be configured to start only with the supply air fan. In this mode, the extract air fan is not active. This requires a digital output to be configured, which controls the recirculation damper to open completely so the supply air fan can circulate the air to and from the room.

Read more about support control in *chapter 4.3.8 Support control*

CO₂ control

In applications with varying occupancy the fan speeds or mixing dampers can be controlled by the air quality as measured by a CO₂ sensor.

With the CO₂ function it's possible to start and stop the fans, compensate the fan speed and in combination with mixing damper let in more outdoor air depending on the CO₂ value. This can be configured with the CO₂ control settings, see *Table 5-13 CO₂ control settings*.

Read more about the CO₂ function in *4.4.3 Demand controlled ventilation* .

Table 5-13 CO₂ control settings

Fan stop/start function	When the function is activated with start/stop function and the CO ₂ value rises above settable start value the fans will start at configured speed (default: normal speed), if they are not already running.
Mixing damper function	If demand controlled ventilation is activated in combination with mixing dampers, and the CO ₂ -value rises above the setpoint value the dampers controlled by a sequence with CO ₂ function will be overtaken by the CO ₂ controller and let in more outdoor air. The function is controlled by a PI-controller.
Fan start/stop + mixing damper	If demand controlled ventilation is activated in combination with mixing dampers, and the CO ₂ -value rises above the setpoint value the dampers controlled by a sequence with CO ₂ function will be overtaken by the CO ₂ controller and let in more outdoor air. The function is controlled by a PI-controller.

Inputs and outputs	
AI	CO ₂ -sensors

Free cooling

This function is used during the summer to cool the building night-time using cool outdoor air, thereby reducing the need for cooling during the day and saving energy.

Free cooling requires an outdoor sensor or an intake temperature sensor and either a room sensor or an extract air sensor. If both an outdoor sensor and an intake sensor is configured it uses the outdoor sensor for the function.

Free cooling is only activated when all the start conditions below are fulfilled.

- ✓ Less than four days have passed since the unit was last in running mode.
- ✓ The outdoor temperature during the previous running period exceeded a set limit (22°C).
- ✓ It is between 00:00 and 07:00:00 in the day (settable).
- ✓ The timer outputs for *Normal* speed, *Extended running*, *Normal* and *External switch* are **Off**.
- ✓ A timer channel will be **On** sometime during the next 24 hours.

If an intake sensor is used and/or an extract air sensor is selected and ALL the start conditions are fulfilled, free cooling is activated and will run for 3 minutes (settable) to ensure that the temperature measurement when using an extract air sensor reflects the corresponding room temperature and that the intake temperature sensor senses the outdoor temperature even if it is placed in the fresh air inlet duct. If an outdoor sensor and a room sensor is selected, the unit will not start free cooling as long as all the temperatures are not within the start and stop temperature intervals.

Read more about free cooling in *chapter 4.3.9 Free cooling*.

Inputs and outputs	
AI	Outdoor temperature sensor or Intake temperature
AI	Room sensor or Extract air sensor
DO	Free cooling operation

Recirculation

Recirculation is a function for distributing the air in the room using the supply air fan. The function can be used even when there is no heating or cooling demand. When using recirculation control, the extract air fan stops (but can also be set to run) and a recirculation damper opens which allows the air to circulate through the unit.

Recirculation is activated either via a digital input signal or by connecting it to *Extra time channel 4* (Application tool - Time control). If timer output for *Low/Normal/High* speed is activated during

recirculation via *Extra time channel 4, Low/Normal/High* speed gets priority. If timer output for *Low/Normal/High* speed is activated during recirculation activated by a digital input, recirculation gets priority.

Either a digital output (Recirculation damper) or an analogue output sequence (A to J) can be used as an on/off output signal.

Recirculation control can be configured as either air circulation (temperature control inactive) or air circulation with temperature control. (Only heating, only cooling or both heating and cooling). Recirculation control has its own setpoint. However, the other settings are the same as for normal operation, i. e. if normal operation has been configured as room control, room control will also be used during recirculation.

Read more about Recirculation in *chapter 4.3.14 Recirculation*

Pretreatment

Control of dampers and pump for preheated or pre-cooled outdoor air via an underground intake channel.

The digital output *Pretreatment* is set to preheating when the unit is started and the outdoor temperature is below the set heating start limit or to precooling when the outdoor temperature is above the set cooling start limit. If the outdoor temperature exceeds the set heating start limit by more than 1°C, preheating will be aborted, as well as if the outdoor temperature falls below the cooling start limit by 1°C.

Read more about pretreatment in *chapter 4.7 Pretreatment*

Extra controller

An extra controller can be used as an independent temperature control circuit for control of for example separate zones. The circuit can be configured to heating or cooling. It has an analog input signal for temperature sensors and an analogue output signal (0...10 V). There is also a digital output signal which is activated when the analogue output signal is above 1 V and deactivated when the analogue signal is below 0.1 V. The circuit can be configured to be active all the time or to be active only when the unit is running or when defrosting.

Read more about the extra controller in *4.13 Extra controller*

Fire / Smoke

Fire dampers are normally configured to open on fire alarm but can be configured to be normally open instead. It is possible to configure which speed the fans should have when in fire mode – however, this is not possible when the fire function has been set to *Running via normal start/stop conditions*. Read more about the fire/smoke function in *4.6.2 Fire/smoke dampers*.

Inputs and outputs	
DO	Outdoor air damper
DO	Exhaust air damper
DO	Fire damper
DI	Fire alarm
DI	Fire damper end switch monitoring

Humidity control

Humidity control can be configured as Humidification, Dehumidification or both Humidification and Dehumidification.

Two humidity sensors can be connected, a room sensor for control and an optional duct sensor for maximum limiting. The limit sensor can be omitted.

The humidity control is handled by a PI-controller.

The humidity sensors must give 0...10 V DC for 0...100 % RH.

Read more about Humidity control in *4.8 Humidity control*

Humidification	An analogue output is used to control a humidifier. The output will increase on decreasing humidity. A digital output can also be used to start a humidifier.
Dehumidification	An analogue output (<i>Humidity</i>) is used to control a dehumidifier. The output will increase on increasing humidity. A digital output can also be used to start a dehumidifier.
Humidification + Dehumidification	An analogue output (<i>Humidity</i>) is used to control a humidifier. The output will increase on decreasing humidity. For dehumidification it's configurable which sequence that should be activated for dehumidification through condensation. The output will increase on increasing humidity. This signal overrides the cooling signal from the temperature controller so the output can be activated for dehumidification even if the temperature controller demand is zero.

Filter monitoring

Turn on filter monitoring to monitor the flow through the filter. Analog filter guards may be made air flow dependent. This means that a higher pressure drop is permitted across a filter at a higher air flow. For this purpose, X and Y coordinates are used to set the linear function that should be followed at a pressure drop alarm.

Read more about filter monitoring in *chapter 4.9 Filter monitoring*

Extended operation

The digital inputs for extended running can be used to force the unit to start in reduced, normal or high speed although the timer says the running mode should be **Off**. This digital input has always higher priority than running via time schedule.

The unit will run for the set time. If the running time is set to 0 the unit will only run as long as the digital input is closed.

Read more about extended operation in *chapter 4.10 Extended operation and External stop*

External stop

The signal *External switch* will stop the unit, even if the timer or one of the signals *Extended Operation, Low, Extended Operation, Normal* or *Extended Operation, High* says it should stay in running mode.

Read more about external stop in *chapter 4.10 Extended operation and External stop*

Extra fan motor control

External control of an external fan motor can be configured. The fan is started via either a digital input, time channel 4 or when the unit is started.

Read more about extra fan motor control in *4.4.4 Extra fan motor control*

Control mode	Start / Stop
0	Only on DI
1	When unit is running
2	Time channel 4

A digital output activates the fan motor. A digital input is available for run time indication/motor protection.

Damper

The outdoor air and exhaust air ducts close-off dampers can be controlled by digital outputs or be hard-wired to the supply air fan relays for normal, reduced and high speed in such a fashion that the damper is open when the supply air fan is running. When using pressure controlled fans the digital activation signal is activated as soon as the fan has start conditions. This signal can be used to open the close-off damper.

Damper location to choose from:

- ✓ Outdoor
- ✓ Outdoor + Exhaust
- ✓ Exhaust

Read more about dampers in *chapter 4.6 Damper control*

Automatic restart after power on

This function makes it possible to block automatic restart of the unit at power-up. At power-up, the B-alarm *Restart blocked after power on* is generated. Once this alarm has been acknowledged, the unit will start. See more about alarms in *5.12 Alarm status*.

5.5.2 Sequences

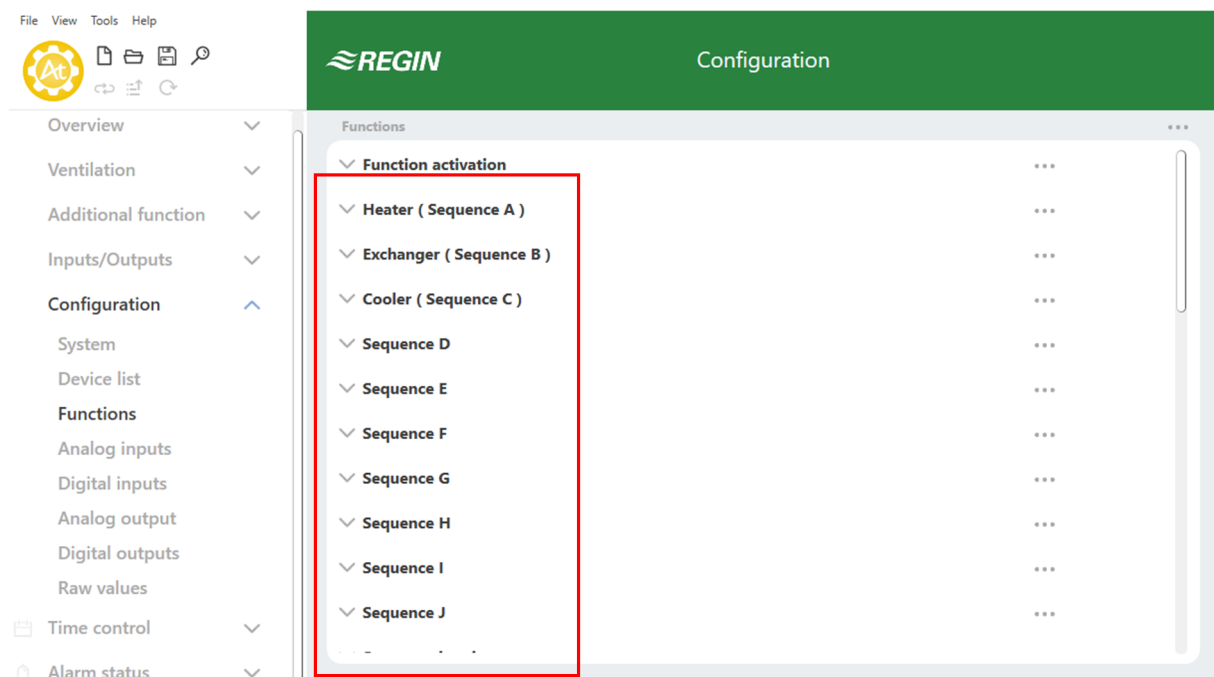

Figure 5-8 Application Tool - Configuration - Functions

There are ten sequences (A to J) that can be configured in the Corrigo. Each sequence will have their own PID-settings and a PWM digital output signal (Pulse Width Modulation).

The sequence types that can be configured are:

- ✓ Not used
- ✓ Heating
- ✓ Cooling
- ✓ Exchanger

- ✓ Damper
- ✓ Fan setpoint compensation

The default settings are:

- ✓ A = Heating
- ✓ B = Exchanger
- ✓ C = Cooler
- ✓ D to J = Not used



Note! The sequence menus are adaptive and the setting options will change depending on the selections you make in other menus.

Read more about sequences in *chapter 4.3 Temperature sequences*

Heater sequence

The table below shows the possible settings for a Heater sequence. Not all settings are visible for any type of heater.

Table 5-14 Sequence alternatives

Application tool	Setting alternatives	Note
Name	Free choice	
Type of sequence	Heating	
Type of heater	<ul style="list-style-type: none"> ✓ Inactive ✓ Water ✓ Electric ✓ DX (Direct exchanger) ✓ DX split 	
Type of freeze protection	<ul style="list-style-type: none"> ✓ None ✓ Temperature sensor ✓ Freeze guard ✓ Sensor + Guard 	
Freeze protection temperature sensor	<ul style="list-style-type: none"> ✓ None ✓ 1 ✓ 2 ✓ 3 	
Pump control	Yes / No	
Pump stop mode	<ul style="list-style-type: none"> ✓ Always running ✓ Auto 	
Type of pump indication	<ul style="list-style-type: none"> ✓ None ✓ Alarm ✓ Run Indication 	
Digital start output	Yes / No	
Actuator runtime (s)	Writable. Default 255 s	
Period time for PWM-signal (s)	Writable. Default 60 s	
Sequence output when recirculation/ support	<ul style="list-style-type: none"> ✓ 0 % ✓ 100 % ✓ Auto 	
Sequence output min limit (%)	Writable	
Sequence output max limit (%)	Writable	
Sequence output when the unit is stopped (%)	Writable	

Table 5-14 Sequence alternatives (continued)

Application tool	Setting alternatives	Note
Sequence output when fire mode	0, 1, Auto	
Sequence output when smoke mode	0, 1, Auto	

Cooler sequence

The table below shows the possible settings for a Cooler sequence. Not all settings are visible for any type of cooler.

Table 5-15 Sequence alternatives

Application tool	Setting alternatives	Note
Name	Free choice	
Type of sequence	Cooling	
Type of cooler	<ul style="list-style-type: none"> ✓ Inactive ✓ Water ✓ DX (Direct exchanger) ✓ DX with exchanger control ✓ DX split 	
Pump control	Yes / No	
Pump stop mode	<ul style="list-style-type: none"> ✓ Always running ✓ Auto 	
Type of pump indication	<ul style="list-style-type: none"> ✓ None ✓ Alarm ✓ Run Indication 	
Digital start output	Yes / No	
Actuator runtime (s)	Writable. Default 255 s	
Period time for PWM-signal (s)	Writable. Default 60 s	
Sequence output when recirculation/ support	<ul style="list-style-type: none"> ✓ 0 % ✓ 100 % ✓ Auto 	
Sequence output min limit (%)	Writable	
Sequence output max limit (%)	Writable	
Sequence output when the unit is stopped (%)	Writable	

Exchanger sequence

The table below shows the possible settings for an Exchanger sequence. Not all settings are visible for any type of heater.

Table 5-16 Sequence alternatives

Application tool	Setting alternatives	Note
Name	Free choice	
Type of sequence	Exchanger	
Type of exchanger	<ul style="list-style-type: none"> ✓ Inactive ✓ Rotating ✓ Plate ✓ Liquid 	
Digital start output	Yes / No	

Table 5-16 Sequence alternatives (continued)

Application tool	Setting alternatives	Note
Actuator runtime (s)	Writable. Default 255 s	
Period time for PWM-signal (s)	Writable. Default 60 s	
Exchanger alarm	Yes / No	
Defrosting mode	<ul style="list-style-type: none"> ✓ No defrosting ✓ Defrosting temperature monitoring 	
Freeze prevention rotation exchanger	Yes / No	
Sequence output when recirculation/ support	<ul style="list-style-type: none"> ✓ 0 % ✓ 100 % ✓ Auto 	
Sequence output min limit (%)	Writable	
Sequence output max limit (%)	Writable	
Sequence output when the unit is stopped (%)	Writable	

Damper sequence

The table below shows the possible settings for a Damper sequence. Not all settings are visible for any type of heater.

Table 5-17 Sequence alternatives

Application tool	Setting alternatives	Note
Name	Free choice	
Type of sequence	Damper	
Digital start output	Yes / No	
Actuator runtime (s)	Writable. Default 255 s	
Period time for PWM-signal (s)	Writable. Default 60 s	
Exchanger alarm	Yes / No	
Enable enthalpy control	Yes / No	
CO2 control	<ul style="list-style-type: none"> ✓ No ✓ CO2 sequence 1 ✓ CO2 sequence 2 	
CO2 control mode	<ul style="list-style-type: none"> ✓ Decreasing ✓ Increasing 	
Sequence output when recirculation/ support	<ul style="list-style-type: none"> ✓ 0 % ✓ 100 % ✓ Auto 	
Sequence output min limit (%)	Writable	
Sequence output max limit (%)	Writable	
Sequence output when the unit is stopped (%)	Writable	

Fan setpoint compensation sequence

The table below shows the possible settings for a Fan setpoint compensation sequence. Not all settings are visible for any type of heater.

Table 5-18 Sequence alternatives

Application tool	Setting alternatives	Note
Name	Free choice	
Type of sequence	Fan setpoint compensation	
Type of setpoint compensation	<ul style="list-style-type: none"> ✓ Inactive ✓ Decrease ✓ Increase 	
Digital start output	Yes / No	
Sequence output when recirculation/ support	<ul style="list-style-type: none"> ✓ 0 % ✓ 100 % ✓ Auto 	
Sequence output min limit (%)	Writable	
Sequence output max limit (%)	Writable	
Sequence output when the unit is stopped (%)	Writable	

Starting order heating/cooling

Setting of the order of the sequences is made in *Configuration* ▶ *Functions* ▶ *Sequence heating/cooling*.

It is possible to define a specific start order for the different sequences for heating and cooling demand.

The selectable number, 1...10, defines the start order of the sequences. If two sequences have the same start order they will work in parallel.

Start order heating shows only sequences which can work as a heating sequence, such as:

- ✓ Heater
- ✓ Exchanger
- ✓ Damper
- ✓ Fan setpoint compensation

Start order cooling shows only sequences which can work as a cooling sequence, such as:

- ✓ Cooler
- ✓ Exchanger
- ✓ Damper
- ✓ Fan setpoint compensation

The following picture (5-9) shows the default settings of the configured sequences A=Heater, B=Exchanger and C=Cooler, where the Exchanger (SEQ. B) starts first in heating mode followed by the Heater (SEQ. A). In cooling mode, the Exchanger (SEQ. B) starts first followed by the Cooler (SEQ. C).

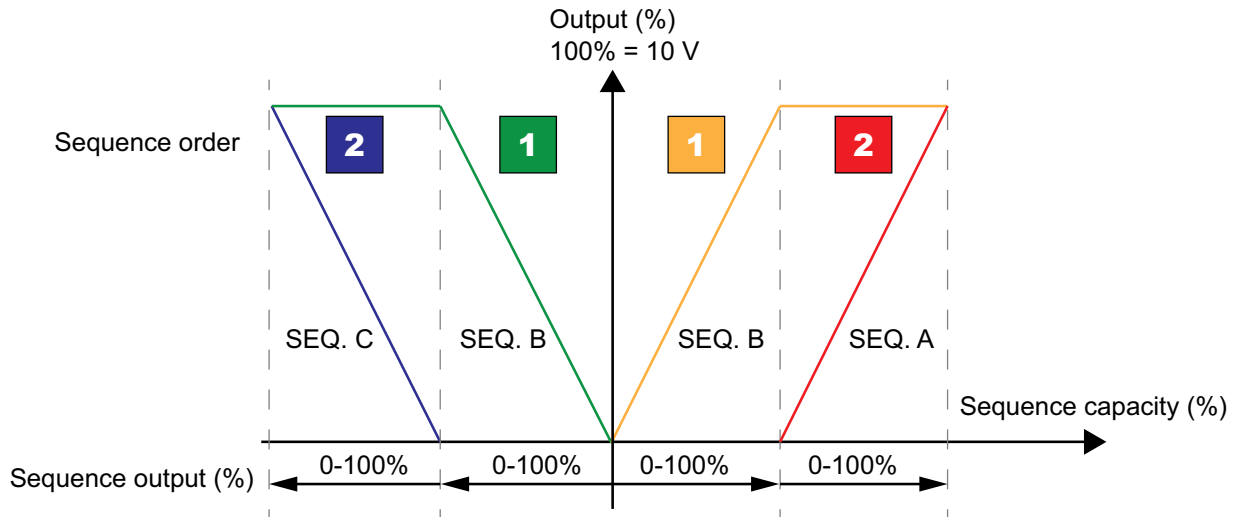

Figure 5-9 Sequence order

Sequence settings

These settings are used to define the start of the sequences when the unit starts. There are two different modes to start the unit:

- ✓ Normal start up
- ✓ Warm (Heat) start up

Normal start up:

The sequence control starts at 100% for the heating sequence which is selected at the parameter *At start up begin temperature control at 100% in*. The default setting is *Heating 1*, which means it starts at 100% for heating sequence 1 which is the exchanger in the default configuration.

Warm start up:

If the outdoor temperature is lower than the settable limit *Warm start up if outdoor temperature < (°C)* the unit will start in the warm start mode. A second sequence will start at 100% in this mode if the unit starts. The default setting is *Heating 2*, which means it starts at 100% for the heating sequence 2 which is the heater in the default configuration.

Table 5-19 Sequence settings

Application tool	Setting alternatives	Note
At start up begin temperature control at 100 % in	<ul style="list-style-type: none"> ✓ Heating 1 0% ✓ Heating 1...10 	
Warm start up if outdoor temperature < (°C)	Writable	
If warm start up begin temperature control at 100 % in	<ul style="list-style-type: none"> ✓ Heating 1 0% ✓ Heating 1...10 	

Temperature control

Table 5-20 Temperature control

Application tool	Setting alternatives	Note
Room temperature sensor	None / 1...16	
Room temperature average	<ul style="list-style-type: none"> ✓ No ✓ Minimum ✓ Maximum ✓ Average ✓ Average remove min / max ✓ Median 	How to display the room temperature value.
Outdoor temperature sensor	<ul style="list-style-type: none"> ✓ No ✓ Intake air ✓ Outdoor ✓ Outdoor + intake air 	Which temperature the outdoor sensor measures
Extract air temperature sensor	Yes / No	
Supply air temperature sensor	Yes / No	
Exhaust air temperature sensor	Yes / No	
Activate summer mode	<ul style="list-style-type: none"> ✓ No summer setpoint ✓ Switch with calendar ✓ Switch with changeover ✓ Switch with digital input ✓ Switch with outdoor temp 	
External setpoint device	<ul style="list-style-type: none"> ✓ No ✓ TG - R4 ✓ TBI - PT1000 	
Efficiency presentation	Yes / No	
Min temperature difference to show efficiency (°C)	Writable (Default 2)	
Min outdoor temperature to show efficiency (°C)	Writable (Default -100)	
Cooling recovery mode	On / Off	
Temperature difference to start cooling recovery (°C)	Writable (Default 0)	
Fan speed compensated temperature setpoint	<ul style="list-style-type: none"> ✓ None ✓ Low ✓ High ✓ Low & High 	
Defrosting exchanger	Yes / No	
Defrosting temperature sensor	<ul style="list-style-type: none"> ✓ Defrosting sensor ✓ Exhaust air temperature 	
Extract air fan speed when Defrosting with stopped supply air	<ul style="list-style-type: none"> ✓ Auto ✓ Low ✓ Normal ✓ High 	

Changeover 1 and 2

Select the changeover sequence for heating and/or cooling.

Read more about changeover in *chapter 4.3.6 Changeover*

Step controller 1 and 2

Application tool	Setting alternatives	Note
Step controller sequence	Off Sequence A...J Changeover	
Step control	Sequential / Binary	
Number of steps	1...4	
Block output if sequence feedback alarm	Yes / No	

Read more about step control in *chapter 4.3.7 Step controller*

5.5.3 Fan control

Read more about fan control in *chapter 4.4 Fan control*.

Application tool	Setting alternatives	Note
Fan	<ul style="list-style-type: none"> ✓ Supply air + Extract air ✓ Supply air ✓ Extract air 	
Kitchen function	Yes / No	
Flow presentation	Yes / No	
Supply air fan indication	<ul style="list-style-type: none"> ✓ None ✓ Alarm ✓ Run indication 	
Extract air fan indication	<ul style="list-style-type: none"> ✓ None ✓ Alarm ✓ Run indication 	
Extract air fan slaved by exchanger supply air flow	Yes / No	
Flow calculation supply air K-factor	Writable	The K-factor is usually printed on the fan
Flow calculation supply air X-factor	Writable	
Flow calculation extract air K-factor	Writable	The K-factor is usually printed on the fan
Flow calculation extract air X-factor	Writable	
Flow calculation exchanger supply air K-factor	Writable	The K-factor is usually printed on the fan
Flow calculation exchanger supply air X-factor	Writable	
Flow calculation exchanger extract air K-factor	Writable	The K-factor is usually printed on the fan
Flow calculation exchanger extract air X-factor	Writable	
External flow setpoint	Yes / No	
Step control of fans	<ul style="list-style-type: none"> ✓ No ✓ 1 step ✓ 2 step ✓ 3 step 	
Switch point step 1-2 SAF (%)	Writable	
Switch point step 2-3 SAF (%)	Writable	
Switch point step 1-2 EAF (%)	Writable	
Switch point step 2-3 EAF (%)	Writable	
Hysteresis (%)	Writable. Default 5	

Fan compensation curve 1, 2 and 3

Read more about the fan compensation curve in *chapter Compensation curve*

Application tool	Setting alternatives	Description
Fan level	<ul style="list-style-type: none"> ✓ All levels ✓ Low speed ✓ Normal speed ✓ High speed ✓ Low + Normal speed ✓ Normal + High speed 	
Mode	<ul style="list-style-type: none"> ✓ Inactive ✓ In all modes ✓ When defrosting 	
Fan	<ul style="list-style-type: none"> ✓ Supply air fan + extract air fan ✓ Supply air fan ✓ Extract air fan 	
Sensor	<ul style="list-style-type: none"> ✓ Outdoor temperature ✓ Intake air temperature ✓ Supply air temperature ✓ Exhaust air temperature ✓ Extract air temperature ✓ Room temperature 1...10 ✓ Pressure supply air ✓ etc. 	

External flow setpoint

Application tool	Setting alternatives	Note
Operation mode	<ul style="list-style-type: none"> ✓ SAF ✓ EAF ✓ SAF and EAF 	
Factor EAF SAF	Writable (default 1)	The factor is used if there is a difference between the SAF and EAF flow properties.

Read more about External flow setpoint in *chapter External*

Support control

Set if the extract fan will be running or not during support control.

Support control is normally used when room temperature control or extract air control has been configured. When extract air control is configured a room sensor must be installed.

Support control can also be configured to start only with the supply air fan. In this mode, the extract air fan is not active. This requires a digital output to be configured, which controls the recirculation damper to open completely so the supply air fan can circulate the air to and from the room.

Read more about support control in *4.3.8 Support control*

Fire / Smoke

Read more about fire and smoke control in *4.6.2 Fire/smoke dampers*

Application tool	Setting alternatives	Note
Operation mode when fire alarm	<ul style="list-style-type: none"> ✓ Stopped ✓ Continuous run ✓ Running via normal start/stop conditions ✓ Supply air fan run ✓ Extract air fan run 	
Supply air fan setpoint type when fire alarm	<ul style="list-style-type: none"> ✓ Auto ✓ Manual setpoint ✓ Manual output ✓ Low speed setpoint ✓ Normal speed setpoint ✓ High speed setpoint 	
Manual setpoint (Pa), (m ³ /h), (%)	Writable	
Manual output (%)	Writable	
Extract air fan setpoint type when fire alarm	<ul style="list-style-type: none"> ✓ Auto ✓ Manual setpoint ✓ Manual output ✓ Low speed setpoint ✓ Normal speed setpoint ✓ High speed setpoint 	
Outdoor air damper function when fire alarm	<ul style="list-style-type: none"> ✓ Normal function (follow the fan) ✓ Always open ✓ Always closed 	
Exhaust air damper function when fire alarm	<ul style="list-style-type: none"> ✓ Normal function (follow the fan) ✓ Always open ✓ Always closed 	
Fire damper mode	<ul style="list-style-type: none"> ✓ Not active ✓ Dampers normally closed ✓ Dampers normally opened 	
Fire damper test	<ul style="list-style-type: none"> ✓ No test ✓ Test when unit running ✓ Test when unit stopped 	
Operation mode when smoke alarm	<ul style="list-style-type: none"> ✓ Stopped ✓ Continuous run ✓ Running via normal start/stop conditions ✓ Supply air fan run ✓ Extract air fan run 	
Supply air fan setpoint when smoke alarm	<ul style="list-style-type: none"> ✓ Auto ✓ Manual setpoint ✓ Manual output ✓ Low speed setpoint ✓ Normal speed setpoint ✓ High speed setpoint 	
Extract air fan setpoint when smoke alarm	<ul style="list-style-type: none"> ✓ Auto ✓ Manual setpoint ✓ Manual output ✓ Low speed setpoint ✓ Normal speed setpoint ✓ High speed setpoint 	
Outdoor air damper function when smoke alarm	<ul style="list-style-type: none"> ✓ Normal function (follow the fan) ✓ Always open ✓ Always closed 	
Exhaust air damper function when smoke alarm	<ul style="list-style-type: none"> ✓ Normal function (follow the fan) ✓ Always open ✓ Always closed 	

CO₂ control

Setting of the fan speed for CO₂ control on the supply and extract fan.

Read more about CO₂ control in *chapter 4.4.3 Demand controlled ventilation*

Application tool	Setting alternatives	Note
Setpoint supply air fan when CO ₂ control	<ul style="list-style-type: none"> ✓ Low speed ✓ Normal speed ✓ High speed 	
Setpoint extract air fan when CO ₂ control	<ul style="list-style-type: none"> ✓ Low speed ✓ Normal speed ✓ High speed 	

5.5.4 Recirculation

Recirculation of air using a supply air fan and (optionally) extract air fan and a recirculation damper with or without temperature control. Used as a recovery function or during heating with support control during the night. Recirculation control is available as an analog or a digital function.

Read more about recirculation in *chapter 4.3.14 Recirculation*

Application tool	Setting alternatives	Note
Enable supply air temperature control when recirculation	<ul style="list-style-type: none"> ✓ No temperature control ✓ Heating + cooling ✓ Heating ✓ Cooling 	
Enable the night cooling function when recirculation	Yes / No	
Use extra time channel 4 to start recirculation	Yes / No	
Run extract air fan during recirculation	Yes / No	
Fixed setpoint or setpoint offset when circulation run	<ul style="list-style-type: none"> ✓ Fixed setpoint ✓ Setpoint offset 	

5.5.5 Humidity control

It is possible to use either humidification or dehumidification, or to use combined humidification and dehumidification.

Read more about humidity control in *chapter 4.8 Humidity control*

Application tool	Setting alternatives	Note
Select sequence for dehumidify	Sequence A to J	
Type of output	<ul style="list-style-type: none"> ✓ None ✓ Analog ✓ Step ✓ Analog + step 	

5.5.6 Filter monitoring

Read more about filter monitoring in *chapter 4.9 Filter monitoring*

Application tool	Setting alternatives	Note
Type	<ul style="list-style-type: none"> ✓ Sensor ✓ Guard ✓ Sensor + guard 	
Filter placement	<ul style="list-style-type: none"> ✓ Supply air ✓ Extract air ✓ Supply air + Extract air 	
Filter alarm reset	Yes/No	
Filter alarm time (month)	Writable	
Filter alarm supply air limit X1 (m ³ /h)	Writable (Default 0)	
Filter alarm supply air limit X2 (m ³ /h)	Writable (Default 2000)	
Filter alarm supply air limit Y1 (Pa)	Writable (Default 10)	
Filter alarm supply air limit Y2 (Pa)	Writable (Default 150)	
Filter alarm extract air limit X1 (m ³ /h)	Writable (Default 0)	
Filter alarm extract air limit X2 (m ³ /h)	Writable (Default 2000)	
Filter alarm extract air limit Y1 (Pa)	Writable (Default 10)	
Filter alarm extract air limit Y2 (Pa)	Writable (Default 150)	

5.5.7 Extended operation

The digital inputs for extended running can be used to force the unit to start in low, normal or high speed although the timer says the running mode should be **Off**. This digital input has always higher priority than running via time schedule

The unit will run for the set time. If the running time is set to 0 the unit will only run as long as the digital input is closed.

Read more about extended operation in *chapter 4.10 Extended operation and External stop*

Application tool	Setting alternatives	Note
Extended operation low speed	Yes/No	
Extended operation normal speed	Yes/No	
Extended operation high speed	Yes/No	
Extended operation stop delay (min)	Writable	

5.5.8 Pretreatment

Damper and pump control for preheating or precooling of the outdoor air via an underground intake channel.

Select if pretreatment should be activated during free cooling.

Read more about pretreatment in *chapter 4.7 Pretreatment* and about free cooling in *chapter 4.3.9 Free cooling*.

5.5.9 Extra controller

Read more about extra controller in *chapter 4.13 Extra controller*

Application tool	Setting Alternatives	Note
Start / Stop function	<ul style="list-style-type: none"> ✓ Always running ✓ Unit running ✓ When defrosting ✓ Extra time channel 1...3 	
Control mode	<ul style="list-style-type: none"> ✓ Heating ✓ Cooling 	
Type of freeze protection	Freeze protection temperature 1...3	
Pump control	Yes / No	
Pump running mode	<ul style="list-style-type: none"> ✓ Always running ✓ Auto 	
Type of feedback	<ul style="list-style-type: none"> ✓ None ✓ Alarm ✓ Run indication 	
Digital start output	Yes / No	
Extra contr. output when recirculation/ support	<ul style="list-style-type: none"> ✓ 0 ✓ 1 ✓ Auto 	
Sequence output min limit (%)	Writable (Default 0)	
Sequence output max limit (%)	Writable (Default 100)	

5.5.10 Extra fan motor control

Read more about extra fan motor control in *chapter 4.4.4 Extra fan motor control*

Application tool	Setting Alternatives	Note
Type of feedback fan motor 1 (2)	<ul style="list-style-type: none"> ✓ None ✓ Alarm ✓ Run indication 	
Start/stop function fan motor 1(2)	<ul style="list-style-type: none"> ✓ Digital input ✓ Unit running ✓ Extra time channel 4 	

5.5.11 Extra indications & outputs

Application tool	Setting alternatives	Note
Extra time channel	<ul style="list-style-type: none"> ✓ No ✓ 1...4 	
Run indication	Yes / No	
Sum alarm outputs	<ul style="list-style-type: none"> ✓ None ✓ A / B alarm ✓ A - alarm + B - alarm ✓ A - alarm + B / C - alarm 	
Free cooling running	Yes / No	
Analog signal output	<ul style="list-style-type: none"> ✓ None ✓ Outdoor temperature ✓ Intake air temperature ✓ Supply air temperature ✓ Exhaust air temperature ✓ Extract air temperature ✓ Room temperature 1...16 ✓ Defrosting temperature ✓ etc. 	
Temperature at Vmin (°C)	Writable (Default -50)	
Temperature at Vmax (°C)	Writable (Default 150)	

Application tool	Setting alternatives	Note
Alarm output	Writable (Default 0)	
Alarm name		

5.5.12 Extra sensors & inputs

Application tool	Setting Alternatives	Note
Alarm acknowledgements	Yes / No	
Extra sensors	<ul style="list-style-type: none"> ✓ No ✓ 1...5 	
Extra alarm	<ul style="list-style-type: none"> ✓ Off ✓ 1...10 	

5.5.13 Room unit

A room unit, ED-RUX, can be configured via Application tool.

Application tool	Setting alternatives	Note
Temperature to show in ED-RUX	<ul style="list-style-type: none"> ✓ Room temperature of the display ✓ Room temperature from sensor connected to controller ✓ Outdoor temperature ✓ Supply air temperature ✓ Extract air temperature 	
Function on/off button	<ul style="list-style-type: none"> ✓ No function ✓ Not used ✓ On / Off function ✓ On/Off/Extended operation function 	
Fan speed extended run	<ul style="list-style-type: none"> ✓ Low speed extended run ✓ Normal speed extended run ✓ High speed extended run 	
Extended operation (min)	Writable (Default: 60)	
Minimum setpoint adjustment (°C)	Writable (Default -3)	
Maximum setpoint adjustment (°C)	Writable (Default 3)	

5.5.14 Alarms

Set the Alarm delay time at start up. Default: 60 s.

Read more about alarms in *chapter 3.6 Alarm events and alarm handling* and *chapter Appendix D Alarm list*

5.6 Configuration - Inputs and Outputs

Any control signal can be bound to any in- and output, the only restriction being that digital signals cannot be bound to analog inputs and vice versa. It is up to the user doing the binding to make sure that activated functions are bound to appropriate in- and outputs.



Warning! Configuration of a physical output to more than 1 function will cause in an undefined behaviour of the controller. Alarm 194 - Internal alarm will then become active i.

5.6.1 Analog inputs, AI

All analogue inputs are for Pt1000, Ni1000LG, Ni1000 or 0...10 V.

Input signals can be compensated e.g. for wiring resistance.

The raw value will show the actual, uncompensated input value.

See *Appendix C Input and output lists* for a complete list of inputs and outputs.



Note! The menu is adaptive and not all items will be shown, depending on your previous selections.



Note! A manual mode can be activated by setting the parameter *Mode* to *Off* or *Manual*. In this case it's not necessary to configure a physical input, the application will work with the manual value instead.

The settings that can be selected / configured are:

Table 5-21 Analog inputs

Variable	Settings	Note
Device	<ul style="list-style-type: none"> ✓ Controller ✓ Expansion unit 1...10 	Select a controller or an expansion unit
Terminal	<ul style="list-style-type: none"> ✓ Off ✓ AI 1...32 ✓ UAI 1...4, 27, 28 ✓ UI 1, 2 ✓ Temperature 	The number of terminals are depending on Corrigo model
Name	Writable	Free choice
Signal type	Read only	
Sensor type	<ul style="list-style-type: none"> ✓ Pt1000 ✓ Ni1000LG ✓ Ni1000 ✓ 0...10 V 	
Min input (V)	Writable (Default 0)	
Max input (V)	Writable (Default 10)	
Min signal (°C)	Writable (Default 0)	
Max signal (°C)	Writable (Default 100)	
Filter factor	Writable (Default 0,2)	The filter factor is the damping you want the program to work with in order to reduce the influence of potential signal fluctuations on the sensor input. A new value is calculated using the following formula: $New\ value = old\ value * filter\ factor + raw\ value * (1 - filter\ factor)$
Compensation (°C)	Writable (Default 0)	
Mode	<ul style="list-style-type: none"> ✓ Off ✓ Manual ✓ Auto 	
Manual (°C)	Writable (Default 0)	
Actual value (°C)	Read only	

5.6.2 Digital inputs, DI

To simplify adaptation to external functions, all digital inputs can be configured to be either normally open, NO, or normally closed, NC. The inputs are as default normally open, i. e. if the input is closed, the function connected to the input in Corrigo is activated.

See *Appendix C Input and output lists* for a complete list of inputs and outputs.



Caution! Be careful when changing the input from NO to NC since some digital functions can be configured to either NO or NC themselves. For example, you can choose if the fire alarm input should be activated when it is closed or opened. Therefore, there is a risk that the signal is changed twice and the result is the opposite of the desired.



Note! The menu is adaptive and not all items will be shown, depending on your previous selections.

The settings that can be selected / configured are:

Table 5-22 Digital inputs

Variable	Settings	Note
Device	<ul style="list-style-type: none"> ✓ Controller ✓ Expansion unit 1...10 	Select a controller or an expansion unit
Terminal	<ul style="list-style-type: none"> ✓ Off ✓ DI 1...8 ✓ UDI 1...4 ✓ UI 1, 2 	The number of terminals are depending on Corrigo model
Name	Writable	Free choice
NC / NO	<ul style="list-style-type: none"> ✓ NO ✓ NC 	<ul style="list-style-type: none"> ✓ NC (Normally closed) ✓ NO (Normally open)
Mode	<ul style="list-style-type: none"> ✓ Off ✓ Manual ✓ Auto 	
Actual value (°C)	Read only	

5.6.3 Analog outputs, AO

See *Appendix C Input and output lists* for a complete list of inputs and outputs.



Warning! Configuration of a physical output to more than 1 function will cause in an undefined behaviour of the controller. Alarm 194 - Internal alarm will then become active i.

Table 5-23 Analog outputs

Variable	Settings	Note
Device	<ul style="list-style-type: none"> ✓ Controller ✓ Expansion unit 1...10 	Select a controller or an expansion unit
Terminal	<ul style="list-style-type: none"> ✓ Off ✓ AO 1...5 	The number of terminals are depending on Corrigo model
Name	Writable	Free choice
Range output	<ul style="list-style-type: none"> ✓ 0...10 V ✓ 2...10 V ✓ 10...2 V ✓ 10...0 V 	

5.6.4 Digital outputs, DO

Digital outputs can be NC (Normally Closed) or NO (Normally Opened).

See *Appendix C Input and output lists* for a complete list of inputs and outputs.



Warning! Configuration of a physical output to more than 1 function will cause in an undefined behaviour of the controller. *Alarm 194 - Internal alarm* will then become active.

Table 5-24 Digital outputs

Variable	Settings	Note
Device	✓ Controller ✓ Expansion unit 1...10	Select a controller or an expansion unit
Terminal	✓ Off ✓ DO 1...7	The number of terminals are depending on Corrigo model
Name	Writable	Free choice
NC / NO	✓ NO ✓ NC	✓ NC (Normally closed) ✓ NO (Normally open)

5.7 Configuration - Raw values

Read the raw values from all I/Os for the controller and/or expansion unit.

5.8 Ventilation



Note! All menus in Application tool are adaptive, which means that they adapt to the function/application you choose to set up. Therefore, not all menu items are available for all applications.

5.8.1 Actual / Setpoint

[Application tool ► Ventilation ► Actual/Setpoint]

Read and adjust setpoints for:

- ✓ Temperature
- ✓ Room controller
- ✓ Extract air controller
- ✓ Supply air controller
- ✓ Humidity
- ✓ CO₂
- ✓ Supply air fan
- ✓ Extract air fan
- ✓ Step controller
- ✓ Freeze protection
- ✓ Exchanger

Temperature

Table 5-25 Setpoints for temperature control

Variable	Read/Write	Default value	Min/Max	Note
Actual control type	R			
Outdoor temperature (°C)	R			
Intake air temperature (°C)	R			
Supply air temperature (°C)	R			
Average room temperature (°C)	R			
Extract air temperature (°C)	R			
Exhaust air temperature (°C)	R			
Setpoint adjustment (°C)	W	0		
Actual setpoint supply air (°C)	R			
Setpoint supply air (°C)	W	18	-20/150	
Actual setpoint room (°C)	R			
Setpoint room air (°C)	W	21	-20/150	
Actual setpoint extract air (°C)	R			
Setpoint extract air (°C)	W	21	-20/150	

Room controller

Table 5-26 Setpoints for room control

Variable	Read/Write	Default value	Min/Max	Note
Room temperature (°C)	R			
Setpoint adjustment (°C)	W	0		
Setpoint offset low speed (°C)	W	0		
Setpoint offset high speed (°C)	W	0		
Setpoint room air (°C)	W	21	-20/150	
Setpoint summer room (°C)	W	24	-20/150	
Actual setpoint room (°C)	R			
Outdoor temperature limit cascade/ supply air (°C)	W	13	-20/40	
Setpoint outdoor curve X1 (°C)	W	-20	-40/40	
Setpoint outdoor curve Y1 (°C)	W	22	10/40	
Setpoint outdoor curve X2 (°C)	W	5	-40/40	
Setpoint outdoor curve Y2 (°C)	W	20	10/40	
Setpoint outdoor curve X3 (°C)	W	20	-40/40	
Setpoint outdoor curve Y3 (°C)	W	20	10/40	
Setpoint outdoor curve X4 (°C)	W	30	-40/40	
Setpoint outdoor curve Y4(°C)	W	22	10/40	
Controller output (%)	R			

Extract air controller

Table 5-27 Setpoints for extract air control

Variable	Read/Write	Default value	Min/Max	Note
Extract air temperature (°C)	R			
Setpoint adjustment (°C)	W	0	-10/10	
Setpoint offset low speed (°C)	W	0	-50/50	
Setpoint offset high speed (°C)	W	0	-50/50	
Setpoint extract air (°C)	W	21	-20/150	
Setpoint summer Extract air (°C)	W	24	-20/150	
Actual setpoint extract air (°C)	R			
Outdoor temperature limit cascade/ supply air (°C)	W	13	-40/40	
Setpoint outdoor curve X1 (°C)	W	-20	-40/40	
Setpoint outdoor curve Y1 (°C)	W	22	10/40	
Setpoint outdoor curve X2 (°C)	W	5	-40/40	
Setpoint outdoor curve Y2 (°C)	W	20	10/40	
Setpoint outdoor curve X3 (°C)	W	20	-40/40	
Setpoint outdoor curve Y3 (°C)	W	20	10/40	
Setpoint outdoor curve X4 (°C)	W	30	-40/40	
Setpoint outdoor curve Y4(°C)	W	22	10/40	
Controller output (%)	R			

Supply air controller

Table 5-28 Setpoints for supply air control

Variable	Read/Write	Default value	Min/Max	Note
Supply air temperature (°C)	R			
Setpoint adjustment (°C)	W	0	-10/10	
Setpoint offset low speed (°C)	W	0	-50/50	
Setpoint offset high speed (°C)	W	0	-50/50	
Setpoint supply air (°C)	W	18	-20/150	
Setpoint summer supply air (°C)	W	24	-20/150	
Neutral zone (°C)	W	0	0/10	
Min limit supply air	W	12	10/150	
Max limit supply air	W	30	10/150	
Reduction of min limit supply air if active DX-cooling (°C)	W	5	0/30	
Actual setpoint supply air (°C)	R			
Setpoint delta T extract air-supply air (°C)	W	-2	-40/150	
Setpoint outdoor curve X1 (°C)	W	-20	-40/40	
Setpoint outdoor curve Y1 (°C)	W	22	10/40	
Setpoint outdoor curve X2 (°C)	W	5	-40/40	
Setpoint outdoor curve Y2 (°C)	W	20	10/40	
Setpoint outdoor curve X3 (°C)	W	20	-40/40	

Table 5-28 Setpoints for supply air control (continued)

Variable	Read/Write	Default value	Min/Max	Note
Setpoint outdoor curve Y3 (°C)	W	20	10/40	
Setpoint outdoor curve X4 (°C)	W	30	-40/40	
Setpoint outdoor curve Y4(°C)	W	22	10/40	
Controller output (%)	R			

Humidity

Table 5-29 Setpoints for humidity control

Variable	Read/Write	Default value	Min/Max	Note
Humidity outdoor (%rH)	R			
Humidity room/extract air (%rH)	R			
Humidity supply air (%rH)	R			
Setpoint humidity room/extract air (%rH)	W	50	0/100	
Humidity control signal (%)	R			

CO₂

Table 5-30 Setpoints for CO₂ control

Variable	Read/Write	Default value	Min/Max	Note
CO2 room/extract air (ppm)	R			
Setpoint mixing damper (ppm)	W	1000	0/2000	

Fans

Table 5-31 Setpoints for fans

Variable	Read/Write	Default value	Min/Max	Note
Setpoint low speed supply air fan (%)	W	25	0/100	
Setpoint low speed extract air fan (%)	W	25	0/100	
Setpoint normal speed supply air fan (%)	W	50	0/100	
Setpoint normal speed extract air fan (%)	W	50	0/100	
Setpoint high speed supply air fan (%)	W	75	0/100	
Setpoint high speed extract air fan (%)	W	75	0/100	
Setpoint low speed supply air fan (Pa)	W	250	0/10000	
Setpoint low speed extract air fan (Pa)	W	250	0/10000	

Table 5-31 Setpoints for fans (continued)

Variable	Read/Write	Default value	Min/Max	Note
Setpoint normal speed supply air fan (Pa)	W	500	0/10000	
Setpoint normal speed extract air fan (Pa)	W	500	0/10000	
Setpoint high speed supply air fan (Pa)	W	750	0/10000	
Setpoint high speed extract air fan (Pa)	W	750	0/10000	
Setpoint low speed supply air fan (m ³ /h)	W	1000	0/60000	
Setpoint low speed extract air fan (m ³ /h)	W	1000	0/60000	
Setpoint normal speed supply air fan (m ³ /h)	W	2000	0/60000	
Setpoint normal speed extract air fan (m ³ /h)	W	2000	0/60000	
Setpoint high speed supply air fan (m ³ /h)	W	3000	0/60000	
Setpoint high speed extract air fan (m ³ /h)	W	3000	0/60000	

Supply air fan

Table 5-32 Setpoints for supply air fan

Variable	Read/Write	Default value	Min/Max	Note
Actual level	R			
Pressure supply air (Pa)	R			
Flow supply air (m ³ /h)	R			
Actual setpoint compensation (Pa, m ³ /h, %)	R			
Actual setpoint (Pa, m ³ /h, %)	R			
Output signal (%)	R			
Bus values SAF-1...5 Frequency (from frequency converter)	R			
Current (from frequency converter) (A)	R			
Power (from frequency converter) (W)	R			
Error (from frequency converter)	R			

Extract air fan

Table 5-33 Setpoints for extract air fan

Variable	Read/Write	Default value	Min/Max	Note
Actual level	R			
Pressure extract air (Pa)	R			

Table 5-33 Setpoints for extract air fan (continued)

Variable	Read/Write	Default value	Min/Max	Note
Flow extract air (m ³ /h)	R			
Actual setpoint compensation (Pa, m ³ /h, %)	R			
Actual setpoint (Pa, m ³ /h, %)	R			
Output signal (%)	R			
Bus values EAF-1...5 Frequency (from frequency converter)	R			
Current (from frequency converter) (A)	R			
Power (from frequency converter) (W)	R			
Error (from frequency converter)	R			

Step controller 1 and 2

Table 5-34 Setpoints for stepcontroller 1 and 2

Variable	Read/Write	Default value	Min/Max	Note
Actual binary step	R			

Freeze protection

Table 5-35 Setpoints for freeze protection

Variable	Read/Write	Default value	Min/Max	Note
Freeze protection temperature 1...3 (°C)	R			

Exchanger

Table 5-36 Setpoints for exchanger

Variable	Read/Write	Default value	Min/Max	Note
Defrosting temperature (°C)	R			
Efficiency exchanger (%)	R			

5.8.2 Temperature control

[Application tool ► Ventilation ► Temperature control]

Read more about temperature control in *chapter 4.2 Temperature control*

Sequences

Read more about sequences in *chapter 4.3 Temperature sequences*.

Table 5-37 Setpoints for sequence A to J

Variable	Read/Write	Default value	Min/Max	Note
Digital start output start point (%)	W	10	0/100	
Digital start output stop point (%)	W	1	0/100	
Pump stop delay (min)	W	5	0/600	
Pump-kick hour (h)	W	15	0/23	
Pump running when outdoor temperature < (°C)	W	10	-40/100	
Hysteresis to allow pump stop (°C)	W	1	0/100	
Max fan compensation (%)	W	100	0/100	

Step controller 1 and 2

Read more about step control in *chapter 4.3.7 Step controller*.

Table 5-38 Setpoints for step controller 1 and 2

Variable	Read/Write	Default value	Min/Max	Note
Min switch time (s)	W	60	0/300	
Step 1 start point (%)	W	10	0/100	
Step 1 stop point (%)	W	5	0/100	
Step 2 start point (%)	W	45	0/100	
Step 2 stop point (%)	W	40	0/100	
Step 3 start point (%)	W	70	0/100	
Step 3 stop point (%)	W	65	0/100	
Step 4 start point (%)	W	95	0/100	
Step 4 stop point (%)	W	90	0/100	
Block DX-cooling if outdoor temperature < (°C)	W	1	-40/150	
Block step 1 if supply air fan output signal < (%)	W	0	0/100	
Block step 2 if supply air fan output signal < (%)	W	0	0/100	
Block step 3 if supply air fan output signal < (%)	W	0	0/100	
Block step 4 if supply air fan output signal < (%)	W	0	0/100	
Block step 1 if outdoor temperature < (°C)	W	13	-40/150	
Block step 2 if outdoor temperature < (°C)	W	13	-40/150	
Block step 3 if outdoor temperature < (°C)	W	13	-40/150	
Block step 4 if outdoor temperature < (°C)	W	13	-40/150	
Block all step if outdoor temperature < (°C)	W	0	-40/150	
Hysteresis for decreased output (%)	W	0,5	0/100	

Freeze protection 1, 2 and 3

Read more about freeze protection in *chapter Freeze protection*.

Table 5-39 Setpoints for freeze protection 1, 2 and 3

Variable	Read/Write	Default value	Min/Max	Note
Alarm limitation running mode (°C)	W	7	-40/150	
P-band running mode (°C)	W	5	0/100	
Setpoint standby mode (°C)	W	25	-40/150	

Exchanger

Read more about exchangers in *chapter 4.3.2 Exchanger (Sequence B)*.

Table 5-40 Setpoints for exchanger

Variable	Read/Write	Default value	Min/Max	Note
Start delay exchanger (s)	W	0	0/3600	
Start delay with 100 % exchanger (s)	W	2	0/3600	
Start alarm delay (s)	W	60	0/3600	
Outdoor start/stop exchanger temperature (°C)	W	10	-40/150	
Hysteresis (°C)	W	0,2	0/10	
Defrosting setpoint min limit (°C)	W	-3	-40/150	
Min time deicing (min)	W	5	0/60	
Stop supply air fan if outdoor temp < (°C)	W	-100	-100/150	
Hysteresis to stop defrosting (°C)	W	4	0/10	

Pretreatment

Read more about pretreatment in *chapter 4.7 Pretreatment*

Table 5-41 Setpoints for Pretreatment

Variable	Read/Write	Default value	Min/Max	Note
Pretreatment output	R			
Activate preheater when outdoor temperature < (°C)	W	8	-40/150	
Activate precooler when outdoor temperature >(°C)	W	19	-40/150	
Hysteresis (°C)	W	1	0/10	
Min difference between outdoor and intake air temperature	W	1	0/20	
Pretreatment block time if difference below min (h)	W	6	0/24	
Min run time (min)	W	5	0/600	

Summer mode

Read more about summer mode in *chapter Room (summer) else supply air outdoor compensated* and *chapter Extract air (summer) else supply air outdoor compensated*.

Table 5-42 Setpoints for Summer mode

Variable	Read/Write	Default value	Min/Max	Note
Date for start of summer period	W	1	1/31	
Month for start of summer period	W	4	1/12	
Date for end of summer period	W	1	1/31	
Month for end of summer period	W	10	1/12	
Outdoor temp for switch between summer / winter (°C)	W	13	0/99	
Outdoor temp hysteresis for switch between summer / winter (°C)	W	0,5	0/99	

5.8.3 Fan control

[Application tool ► Ventilation ► Fan control]

Fans

Table 5-43 Setpoints for fans

Variable	Read/Write	Default value	Min/Max	Note
Actual level supply air fan	R			
Actual level extract fan	R			
Setpoint low speed supply/extract air fan (%)	W	25	0/100	
Setpoint normal speed supply/extract air fan (%)	W	50	0/100	
Setpoint high speed supply/extract air fan (%)	W	75	0/100	
Setpoint low speed supply/extract air fan (Pa)	W	250	0/10000	
Setpoint normal speed supply/extract air fan (Pa)	W	500	0/10000	
Setpoint high speed supply/extract air fan (Pa)	W	750	0/10000	
Setpoint low speed supply/extract air fan (m ³ /h)	W	1000	0/60000	
Setpoint normal speed supply/extract air fan (m ³ /h)	W	2000	0/60000	
Setpoint high speed supply/extract air fan (m ³ /h)	W	3000	0/60000	
Flow supply air (m ³ /h)	R			
Flow extract air (m ³ /h)	R			
Slave factor	W	1	0/1	
Offset supply air fan when free cooling (Pa, m ³ /h, %)	W	0	-30000/ 30000	

Table 5-43 Setpoints for fans (continued)

Variable	Read/Write	Default value	Min/Max	Note
Offset extract air fan when free cooling (Pa, m ³ /h, %)	W	0	-30000/30000	
Offset supply air fan when recirculation (Pa, m ³ /h, %)	W	0	-30000/30000	
Offset extract air fan when recirculation (Pa, m ³ /h, %)	W	0	-30000/30000	

Supply air fan

Table 5-44 Setpoints for supply air fan

Variable	Read/Write	Default value	Min/Max	Note
Start delay (s)	W	60	0/3600	
Stop delay (s)	W	180	0/3600	
Speed during stop delay (%)	W	50	0/100	
Speed change delay (s)	W	10	0/60	
Outdoor air damper stop delay (s)	W	0	0/3600	
Min pressure for supply air fan indication (Pa)	W	25	0/10000	
Min flow for supply air fan indication (m ³ /h)	W	500	0/60000	
Actual setpoint compensation (Pa)	R			
Actual setpoint compensation (m ³ /h)	R			
Actual setpoint compensation (%)	R			
SAF speed min limit (%)	W	0		
SAF speed max limit (%)	W	100		

Extract air fan

Table 5-45 Setpoints for extract air fan

Variable	Read/Write	Default value	Min/Max	Note
Start delay (s)	W	0	0/3600	
Stop delay (s)	W	30	0/3600	
Speed during stop delay (%)	W	0	0/100	
Speed change delay (s)	W	10	0/60	
Exhaust air damper stop delay (s)	W	0	0/3600	
Min pressure for extract air fan indication (Pa)	W	25	0/10000	
Min flow for extract air fan indication (m ³ /h)	W	500	0/60000	
Actual setpoint compensation (Pa)	R			
Actual setpoint compensation (m ³ /h)	R			
Actual setpoint compensation (%)	R			

Table 5-45 Setpoints for extract air fan (continued)

Variable	Read/Write	Default value	Min/Max	Note
EAF speed min limit (%)	W	0		
EAF speed max limit (%)	W	100		

Fan compensation curve 1, 2 and 3

Read more about fan compensation in *chapter Compensation curve*.

Table 5-46 Setpoints for fan compensation curve 1, 2 and 3

Variable	Read/Write	Default value	Min/Max	Note
Lower point X	W	15	-30000/ 30000	
Lower point Y (Pa, m ³ /h, %)	W	0	-30000/ 30000	
Middle point X	W	20	-30000/ 30000	
Middle point Y (Pa, m ³ /h, %)	W	0	-30000/ 30000	
Higher point X	W	25	-30000/ 30000	
Higher point Y (Pa, m ³ /h, %)	W	0	-30000/ 30000	

5.8.4 Demand control

[Application tool ► Ventilation ► Demand control]

CO₂

Read more about demand control and CO₂ in *chapter 4.4.3 Demand controlled ventilation*

Table 5-47 Setpoints for CO₂

Variable	Read/Write	Default value	Min/Max	Note
Start limit fan start/stop (ppm)	W	800	0/2000	
Stop hysteresis fan start/stop (ppm)	W	160	0/2000	
Demand control	R			
Min time for CO ₂ control (min)	W	20	0/600	

Recirculation

Read more about recirculation in *chapter 4.3.14 Recirculation*

Table 5-48 Setpoints for recirculation

Variable	Read/Write	Default value	Min/Max	Note
Setpoint recirculation (°C)	W	18	-20/150	
Setpoint offset recirculation (°C)	W	0	0/50	
Change to outdoor air when room air > (°C)	W	25	10/50	
Outdoor air damper opened	R			

Free cooling

Read more about free cooling in *chapter 4.3.9 Free cooling*.

Table 5-49 Setpoints for free cooling

Variable	Read/Write	Default value	Min/Max	Note
Free cooling mode	R			
Running when day outdoor temperature > (°C)	W	22	10/40	
Stop when night outdoor temperature > (°C)	W	18	10/40	
Stop when night outdoor temperature < (°C)	W	10	10/40	
Stop when room temperature < (°C)	W	18	10/40	
Free cooling start hour (h)	W	0	0/23	
Free cooling stop hour (h)	W	7	1/24	
Time to block heat output after free cooling (min)	W	60	0/600	
Fan-kick temperature check (s)	W	180	0/3600	
Fan-kick interval time (min)	W	60	0/600	
Start when extract - outdoor > (°C)	W	2	1/5	

Support control

Read more about support control in *chapter 4.3.8 Support control*.

Table 5-50 Setpoints for support control

Variable	Read/Write	Default value	Min/Max	Note
Support control mode	R			
Min time for support control (min)	W	20	0/600	
Start heating room temperature (°C)	W	15	10/40	
Stop heating room temperature (°C)	W	21	10/40	
Setpoint heating (°C)	W	30	-20/150	
Start cooling room temperature (°C)	W	30	10/40	
Stop cooling room temperature (°C)	W	28	10/40	
Setpoint cooling (°C)	W	12	-20/150	

5.8.5 Fire / Smoke

[Application tool ► Ventilation ► Fire/Smoke]

Read more about fire and smoke control in *chapter 4.6.2 Fire/smoke dampers*.

Table 5-51 Setpoints for Fire/Smoke

Variable	Read/Write	Default value	Min/Max	Note
Run fire damper (s)	W	90	0/300	
Test interval fire damper (d)	W	1	0/7	d = day
Test hour fire damper (h)	W	0	0/24	
Feedback fire damper	R			
Fire damper	R			
Status fire damper	R			
Fire alarm	R			
Smoke alarm	R			

5.8.6 Humidity control

[Application tool ► Ventilation ► Humidity control]

Read more about humidity control in *4.8 Humidity control*.

Table 5-52 Setpoints for humidity control

Variable	Read/Write	Default value	Min/Max	Note
Max limit humidity supply air (%rH)	W	80	0/100	
Neutral zone between humidification and dehumidification	W	20	0/100	
Max deviation room/extract air humidity (%rH)	W	10	0/100	
Digital output start point (%rH)	W	15	0/100	
Digital output stop point (%rH)	W	5	0/100	
Hysteresis for max limit humidity supply air (%rH)	W	20	0/100	

5.8.7 PID controllers

[Application tool ► Ventilation ► PID controllers]

Table 5-53 Setpoints for PID-control

Variable	Read/Write	Default value P-band	Default value I-time (s)	Default value D-time (s)
Room controller	W	100 °C	300	-
Extract air	W	100 °C	300	-
Sequence A to J	W	10 °C	100	0
Supply air fan	W	✓ 500 Pa ✓ 1000 m ³ /h (flow)	60	0

Table 5-53 Setpoints for PID-control (continued)

Variable	Read/Write	Default value P-band	Default value I-time (s)	Default value D-time (s)
Extract air fan	W	✓ 500 Pa ✓ 1000 m ³ /h (flow)	60	0
CO2	W	100 ppm	100	0
Freeze protection 1, 2 and 3	W	100 °C	100	
Defrosting	W	16 °C	240	0
Humidity	W	100 %rH	300	0

5.8.8 Energy consumption

[Application tool ► Ventilation ► Energy consumption]

SFP (Specific fan power)

Table 5-54 Setpoints for SFP

Variable	Read/Write	Default value	Min/Max	Note
SFP (kW/m ³ /s)	R			
SFP day average	R			
SFP month average	R			
Frequency converter loss	R			

Power usage fans

The sum of power for all configured fans (SAF or EAF).

Table 5-55 Setpoints for power usage fans

Variable	Read/Write	Default value	Min/Max	Note
Power usage fans (kW)	R			

Today and last 7 days

Total accumulated power usage for today and the last seven days.

Table 5-56 Setpoints for Today and last 7 days

Variable	Read/Write	Default value	Min/Max	Note
Today (kWh)	R			
Yesterday (kWh)	R			
1...6 days before yesterday (kWh)	R			

This year

Total accumulated power usage for each month and total for the current year.

Table 5-57 Setpoints for This year

Variable	Read/Write	Default value	Min/Max	Note
January (kWh)	R			
February (kWh)	R			
March (kWh)	R			
etc...	R			
Total (kWh)	R			

Last year

Total accumulated power usage for each month and total for the previous year.

Table 5-58 Setpoints for This year

Variable	Read/Write	Default value	Min/Max	Note
January (kWh)	R			
February (kWh)	R			
March (kWh)	R			
etc...	R			
Total (kWh)	R			

5.8.9 Manual / Auto

[Application tool ► Ventilation ► Manual/Auto]

Ventilation unit

Table 5-59 Settings for ventilation unit

Variable	Alternatives	Note
Unit operation	<ul style="list-style-type: none"> ✓ Off ✓ Manual ✓ Auto ✓ Low speed ✓ Normal speed ✓ High speed 	
Manual setpoint	<ul style="list-style-type: none"> ✓ Stop ✓ Starting up ✓ Low/Normal/High speed ✓ Support heating ✓ Support cooling ✓ CO2 mode ✓ Free cooling ✓ Cool down mode ✓ Fire mode ✓ Smoke mode ✓ Recirculation mode ✓ Defrosting mode 	

Table 5-59 Settings for ventilation unit (continued)

Variable	Alternatives	Note
Service stop	<ul style="list-style-type: none"> ✓ Inactive ✓ Active 	
Standby mode	<ul style="list-style-type: none"> ✓ On ✓ Off 	
BMS override	<ul style="list-style-type: none"> ✓ Off ✓ Low ✓ Normal ✓ High ✓ Stop ✓ Stop with support control ✓ Free cooling ✓ Recirculation 	

Fan controls

Table 5-60 Settings for fan controls

Variable	Alternatives	Note
Supply air fan	<ul style="list-style-type: none"> ✓ Off ✓ Manual output ✓ Auto ✓ Manual setpoint ✓ Low speed ✓ Normal speed ✓ High speed 	
Manual setpoint (Pa, m3/h, %)	Writable	
Manual output (%)	Writable	
Extract air fan	<ul style="list-style-type: none"> ✓ Off ✓ Manual output ✓ Auto ✓ Manual setpoint ✓ Low speed ✓ Normal speed ✓ High speed 	
Manual setpoint (Pa, m3/h, %)	Writable	
Manual output (%)	Writable	

Sequence A to J

Table 5-61 Settings for sequence A to J

Variable	Alternatives	Note
Mode	<ul style="list-style-type: none"> ✓ Off ✓ Manual ✓ Auto 	
Manual (%)	Writable	
Actual value (%)	Read only	

Sequence A to J analog

Table 5-62 Settings for sequence A to J analog

Variable	Alternatives	Note
Mode	<ul style="list-style-type: none"> ✓ Off ✓ Manual ✓ Auto 	
Manual set (%)	Writable	
Controller output (%)	Read only	

Changeover 1 and 2, Supply air fan, Extract air fan, Humidity control, Step controller 1 and 2, Temperature output

Table 5-63 Settings for changeover, Supply air fan, Extract air fan, Humidity control, Step controller, Temperature output

Variable	Alternatives	Note
Mode	<ul style="list-style-type: none"> ✓ Off ✓ Manual ✓ Auto 	
Manual set (%)	Writable	
Controller output (%)	Read only	

Sequence A to J start, Sequence A to J pump

Table 5-64 Settings for sequence A to J start and pump

Variable	Alternatives	Note
Mode	<ul style="list-style-type: none"> ✓ Off ✓ Manual ✓ Auto 	
Start	Read only	

Supply and Extract air fan start/step 1, Supply and extract air fan step 2 and 3

Table 5-65 Settings for supply and extract air fan start/Step 1, step 2 and 3

Variable	Alternatives	Note
Mode	<ul style="list-style-type: none"> ✓ Off ✓ Manual ✓ Auto 	
Start	Read only	

Dampers

- ✓ Recirculation air damper
- ✓ Outdoor air damper
- ✓ Exhaust air damper
- ✓ Fire damper

Table 5-66 Settings for dampers

Variable	Alternatives	Note
Mode	<ul style="list-style-type: none"> ✓ Off ✓ Manual ✓ Auto 	
Start	Read only	

Alarms

- ✓ Sum alarm 1
- ✓ Sum alarm 2
- ✓ Alarm output

Table 5-67 Settings for alarms

Variable	Alternatives	Note
Mode	<ul style="list-style-type: none"> ✓ Off ✓ Manual ✓ Auto 	
Start	Read only	

Extra time channels 1...4

Table 5-68 Settings for extra time channels 1...4

Variable	Alternatives	Note
Mode	<ul style="list-style-type: none"> ✓ Off ✓ Manual ✓ Auto 	
Start	Read only	

Free cooling indication

Table 5-69 Settings for free cooling indication

Variable	Alternatives	Note
Mode	<ul style="list-style-type: none"> ✓ Off ✓ Manual ✓ Auto 	
Start	Read only	

Pretreatment start

Table 5-70 Settings for Pretreatment start

Variable	Alternatives	Note
Mode	<ul style="list-style-type: none"> ✓ Off ✓ Manual ✓ Auto 	
Start	Read only	

Running indication

Table 5-71 Settings for running indication

Variable	Alternatives	Note
Mode	<ul style="list-style-type: none"> ✓ Off ✓ Manual ✓ Auto 	
Start	Read only	

Humidity control start

Table 5-72 Settings for humidity control start

Variable	Alternatives	Note
Mode	<ul style="list-style-type: none"> ✓ Off ✓ Manual ✓ Auto 	
Start	Read only	

Changeover 1 and 2 (Changeover 1 and 2 start)

Table 5-73 Settings for changeover start

Variable	Alternatives	Note
Mode	<ul style="list-style-type: none"> ✓ Off ✓ Manual ✓ Auto 	
Start	Read only	

Outdoor controlled exchanger

Table 5-74 Settings for outdoor controlled exchanger

Variable	Alternatives	Note
Mode	<ul style="list-style-type: none"> ✓ Off ✓ Manual ✓ Auto 	
Start	Read only	

5.8.10 Status

Status for the ventilation unit and sequences A to J.

Ventilation unit	<ul style="list-style-type: none"> ✓ Actual mode ✓ Schedule mode ✓ External stop ✓ Extended operation ✓ Extended operation time left (min) ✓ Manual mode HMI ✓ Manual mode HMI time left (s) ✓ Free cooling mode ✓ Support control mode ✓ Night operation active last night ✓ Summer mode ✓ Fire alarm input ✓ Smoke alarm input ✓ Frost risk ✓ Internal alarm (alarm 194) ✓ Duplicated AO ✓ Duplicated DO ✓ Current configuration file
Sequence A to J	<ul style="list-style-type: none"> ✓ Analog output (%) ✓ Start ✓ Pump

5.9 Additional function

[Application tool ► Additional function]

5.9.1 Extra controller

An extra controller (independent temperature control circuit) can be added to the Corrigo to control e.g. a separate zone. The controller can be configured to heating or cooling. All the setpoints for the extra controller are in this menu.

Read more about the extra controller in *chapter 4.13 Extra controller*

Setpoints extra controller

Table 5-75 Actual/Setpoint

Variable	Read/Write	Default value	Min/Max	Note
Temperature extra controller (°C)	R			
Setpoint extra controller (°C)	W	18	-20/150	
Controller output (%)	R			

Table 5-76 Temperature control

Variable	Read/Write	Default value	Min/Max	Note
Digital start output start point (%)	W	10	0/100	
Digital start output stop point (%)	W	1	0/100	
Pump stop delay (min)	W	5	0/600	
Pump-kick hour (h)	W	15	0/23	
Pump running when outdoor temperature < (°C)	W	10	-20/150	
Hysteresis to allow pump stop (°C)	W	1	0/10	

Table 5-77 PID controller

Variable	Read/Write	Default value	Min/Max	Description
P-band (°C)	W	33	0/1000	
I-time (s)	W	100	0/9999	
D-time (s)	W	0	0/9999	

Table 5-78 Manual/Auto

Variable	Alternatives	Note
Controller mode	<ul style="list-style-type: none"> ✓ Off ✓ Manual ✓ Auto 	
Manual set (%)	Writable	
Controller output (%)	Writable	
Extra controller start mode	<ul style="list-style-type: none"> ✓ Off ✓ Manual ✓ Auto 	
Start	Read only	
Extra controller pump mode	<ul style="list-style-type: none"> ✓ Off ✓ Manual ✓ Auto 	
Start	Read only	

5.9.2 Motor control 1 and 2

Table 5-79 Control

Variable	Read/Write	Default value	Min/Max	Note
Stop delay motor control (min)	W	0	0/600	

Table 5-80 Manual/Auto

Variable	Alternatives	Note
Mode	<ul style="list-style-type: none"> ✓ Off ✓ Manual ✓ Auto 	
Motor	Read only	

5.10 Inputs / Outputs

[Application tool ► Inputs/Outputs]

In this section, the values for all used Inputs and outputs are displayed.

For wireless sensors, the low battery indication and signal strength (RSSI) are displayed.

5.11 Time control

Corrigo has a year-based clock function. This means that a week-schedule with holiday periods for a full year can be set. The clock has an automatic summertime/wintertime changeover.

It has individual schedules for each weekday plus a separate holiday setting. Up to 24 individual holiday periods can be configured. A holiday period can be anything from one day up to 365 days. Holiday schedules take precedence over other schedules.

This menu displays time, date and weekday, and it permits the setting of time and date.

Time is shown in 24 hour format.

Date is shown in the format YY:MM:DD.

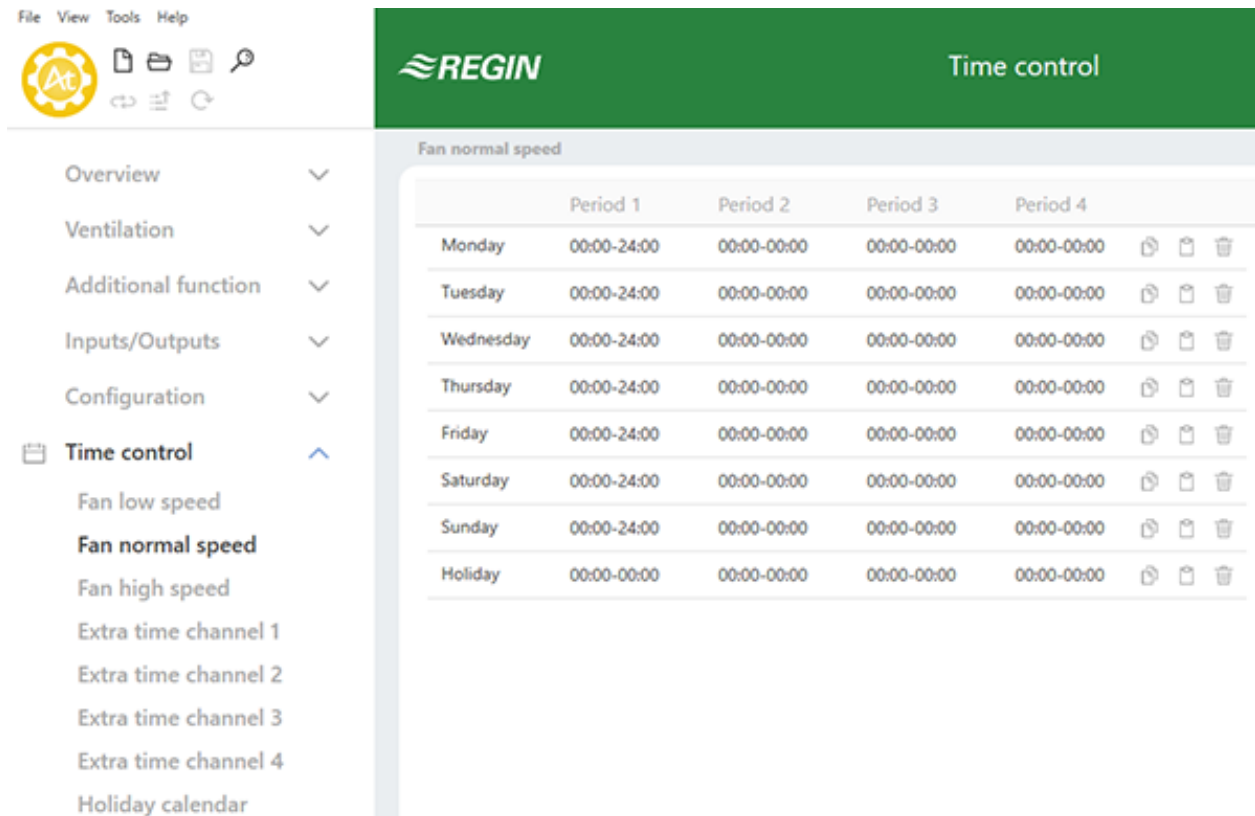

Figure 5-10 Time channels

Each day has up to four individual running periods. For three-speed fans and pressure controlled fans there are daily individual schedules for low speed, normal speed and high speed, each with up to four running periods.

Up to 4 digital outputs can be used as timer controlled outputs . Each with individual week-schedules with two activation periods per day. These outputs can be used to control lighting, door locks etc. (*Configuration ► Digital outputs ► Extra time channel 1...4*)

In the time schedules, four periods are available for each day of the week. Also, four periods are available for days that are configured as holidays in the holiday schedule. During the periods the assigned circuit is working with the corresponding setpoint. Outside of a period the system is off.

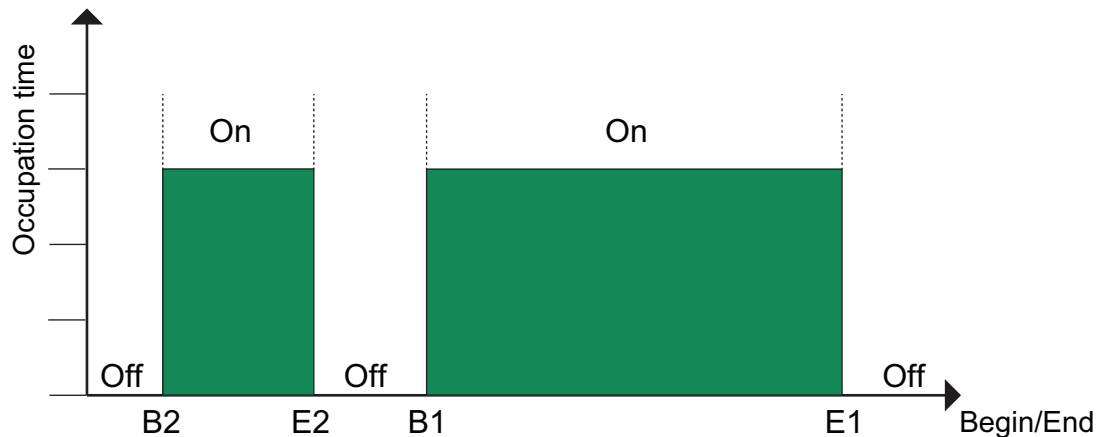

Figure 5-11 Time schedule

The above figure shows an example of period states. It is not possible for periods to overlap each other.

Holiday schedules take precedence over other schedules.

- ✓ For 24 hour running, set a period to 00:00 - 24:00.
- ✓ To inactivate a period, set the time to 00:00 - 00:00. If all periods of a day are set to 00:00 - 00:00, the unit will not run that day.
- ✓ If you want to run the unit from one day to another, e.g. from Monday 22:00 to Tuesday 09:00, the desired running time for both must be entered.



Note! Should periods for the different speeds overlap, high speed takes precedence over normal speed, and normal speed takes precedence over low speed.

See more about Time control in 3.5.3 *Time settings*

5.1.1.1 Extra time channels

Up to four digital outputs can be used as timer controlled outputs. Each with individual week-schedules with four activation periods per day.

Only the time channels which have been configured, i.e. have been wired to a digital output or an additional function, will be shown.

(*Configuration* ► *Digital outputs* ► *Extra time channel 1...4*)

5.1.1.2 Holiday calendar

The system operator can define specific periods of operation or non-operation throughout the year. During these defined periods, the settings in the week schedule do not apply. The holiday calendar includes 24 periods. All holiday periods are working with a special day plan with a maximum of 4 periods.

A holiday period can be any number of consecutive days from 1...365. The dates are in the format: MM:DD.

5.1.1.3 Time settings in display and web interface

The times can also be set using the built-in display and the web interface, see 3.5.3 *Time settings*.

5.12 Alarm status

5.12.1 Alarm handling

Alarms are indicated by the red alarm LED on the front of the unit or on the external display (E3-DSP or ED-T43L-V).

All alarms can be monitored, acknowledged and blocked using the display and buttons, via an external display (E3-DSP, ED-T43L-V), via Application tool or via the web interface. There is also a digital input for acknowledging all alarms.

The alarm settings can be changed in Application tool or in the web interface.

Table 5-81 Inputs and outputs

Inputs and outputs	
DI	Alarm acknowledgement

5.12.2 Alarm configuration

The alarm configuration menu permits configuration of the priority for all alarms. A complete alarm list with default settings and actions, can be found in *Appendix D Alarm list*. It contains all the default alarm texts and priorities.

Priority

Alarms can be given different priority levels **A-alarm**, **B-alarm** and **C-alarm** or **Not active**. Digital outputs can be bound to act as alarm outputs for A-alarms or B/C-alarms or both A- and B/C-alarms. The digital outputs can be inverted, so that an inoperative alarm gives a high output and vice versa. A- and B- alarms must be acknowledged to reset. C- alarms automatically reset as soon as there is no longer a cause for alarm.

The alarm priority that is shown in the display in the event of an alarm can only be changed using Application tool.

Alarm text

The alarm text that is shown in the display in the event of an alarm can be changed using Application tool or the web interface.

Stop function

Each alarm offers the possibility to choose whether an activated alarm should stop the controller or not. The controller can also be set to run at reduced speed during alarms. The latter option can only be configured using Application tool. Automatic restart will take place when the alarm has been acknowledged.

For some alarm types such as electric heating high temperature limit and water heating frost protection it would be dangerous to not stop the unit on alarm. Therefore, for such alarm types, the program will always reset the stop function to **Active** even if the operator should choose **Inactive**.

Unfortunately it is not possible to remove the display text concerning the stop function for these alarm types. This is because the available program space demands that all alarms are treated in the same way in the display.



Note! For alarms that have been set to **Inactive**, the extra stop function should also be set to **Inactive**, or unexpected malfunctions may occur.

Sum alarm

There are two sum alarm functions with two digital outputs:

Inputs and outputs	
DO	Sum alarm 1
DO	Sum alarm 2

The function of the outputs can be individually configured in *Configuration* ▶ *Functions* ▶ *Extra indications & outputs*.

Sum alarm outputs	DO Sum alarm 1	DO Sum alarm 2
None	Not available	Not available
A/B-alarm	Active on A/B-alarm	Not available
A-alarm + B-alarm	Active on A-alarm	Active on B-alarm
A-alarm + B/C-alarm	Active on A-alarm	Active on B/C-alarm

Alarm output

There is one alarm output function with configurable alarm connected to one digital output:

Inputs and outputs	
DO	Alarm output

External alarms

There are 11 possible external alarms. One digital input called **External alarm** and 10 digital inputs called **Extra alarm**.

5.13 Starting and stopping the Corrigo

5.13.1 Start and stop conditions in priority

The unit will start and stop depending on the following conditions in this priority:

1. Service stop (only via display with admin authority)
2. Run in fire mode
3. Stop in fire mode
4. Run in smoke mode
5. Stop in smoke mode
6. Stop due to alarm
7. External stop (DI)

8. Low/normal/high speed due to alarm
9. Start high speed (DI)
10. Start normal speed (DI)
11. Start low speed (DI)
12. Start recirculation (DI)
13. External start/stop (via communication), support control (heat / cool / CO₂) is enabled if external stop with support control is selected
14. Start recirculation (via communication)
15. Start free cooling (via communication)
16. Start/stop in manual mode (off, low, normal, high), manual mode, only one variable used in display, Modbus, BACnet etc.
17. Start high speed via time channel
18. Start normal speed via time channel
19. Start low speed via time channel
20. Start support control (heat / cool / CO₂) via normal start condition
21. Start recirculation via time channel
22. Start free cooling via normal start condition

Possibility to block automatic restart at power - on

The function *Automatic restart at power-on* makes it possible to block automatic restart of the unit at power-up. At power-up, the B-alarm *Restart blocked after power on is generated*. Once this alarm has been acknowledged, the unit will start. (*Configuration ▶ Functions ▶ Function activation*)

5.13.2 Start sequence

Start of the unit will run according to the following sequence:

1. If the controller is configured for water heating and has an outdoor temperature sensor and the outdoor temperature is below a configurable temperature (Full heat at start when outdoor temp is below, default: +3 °C) the heating valve is opened and the heating circulation pump is started (sequence for heat start is configurable). (*Configuration ▶ Functions ▶ Sequence settings*)
2. Signals for outdoor air and exhaust air dampers are activated.
3. If the controller is configured with a heat exchanger the heat exchanger will be run at 100% capacity (sequence for normal start is configurable) for a pre-set time (Start delay with 100% exchanger, default 2 s). (*Ventilation ▶ Temperature control ▶ Exchanger*)
4. The extract air fan or the pressure control of the extract air fan will be started after a preset time (Extract air fan start delay, default 0 s). (*Ventilation ▶ Fan control ▶ Extract air fan ▶ Start delay (s)*)
5. The supply air fan or the control of the supply air pressure will be started after a preset time (Supply air fan start delay, default 60 s). (*Ventilation ▶ Fan control ▶ Supply air fan ▶ Start delay (s)*)
6. Thereafter temperature control according to the configured control mode is started. Electric heating, if configured, is not started until a run signal from the supply air fan or flow switch has been received. And not yet activated pumps will be started.
7. When all fans and pumps is running and exchanger has run for a pre-set time a pre-set delay (Start alarm delay, default 60s) will be activated before the alarm handling system is activated and the unit is in normal running mode. (*Configuration ▶ Functions ▶ Alarms*)

5.13.3 Stop sequence

Stopping of the unit will run according to the following sequence:

1. Deactivation of the alarm handling system.
2. Electric heating, if configured, is shut down.
3. After individually set delay times the fans are stopped; Supply air fan stop delay (Default 180 s), Extract air fan stop delay (Default 30 s) (*Ventilation ▶ Fan control ▶ Extract/Supply air fan ▶ Stop delay (s)*)
4. Outdoor air and exhaust air dampers are shut down. Outdoor air damper close delay: 0-300 seconds (Default: 0 s), Exhaust air damper close delay: 0-300 seconds (Default: 0 s) (*Ventilation ▶ Fan control ▶ Extract/Supply air fan ▶ Stop delay (s)*)
5. Actuator signals are set to zero and the pumps are stopped.
6. If shutdown mode (Frost protection when stopped) is configured, it will be activated.



Note! In order to maintain an acceptable supply air temperature as long as possible, the heat exchanger will continue to run during the stop sequence until everything else is stopped

5.14 Changing the battery

The controller has an internal battery to ensure the operation of the memory and real-time clock in the event of a power failure. When the alarm **Internal Battery** is activated and the battery LED lights up red (24 V models), the battery has become too weak and needs to be changed. Nonetheless, due to a backup capacitor, the controller will function at least 10 minutes without power supply.



Caution! Changing the battery, as well as dismantling and opening the unit requires knowledge of proper ESD protection. Therefore, this should be handled by qualified personnel.

An earthed wristband must be used during this procedure.

5.14.1 24 V models (Corrigo Ardo)

1. Remove the cover by pressing down the locking torques at the edge of the cover using a small screwdriver, and at the same time pulling the cover outwards.



2. Grip the battery firmly with your fingers and lift it upwards until it rises from its holder.

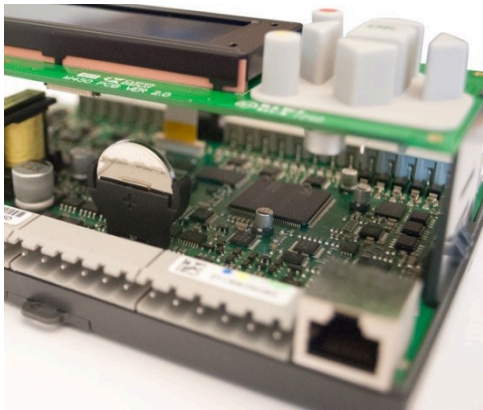

3. Press the new battery firmly down into place.



Note! For proper functionality, ensure that the polarity is correct. The replacement battery must be of type CR2032.

5.14.2 230 V models (Corrigo Vido)

The 230 V models should not be opened by the user. Please contact Regin if you need to change the battery.

6 Information for the installer

6.1 Installation

6.1.1 Corrigo Ardo (24 V)

The controller can be mounted in a DIN-standard casing (minimum 9 modules), on a DIN-rail in a cabinet or, using a suitable front-mounting kit, in a cabinet door or other control panel.

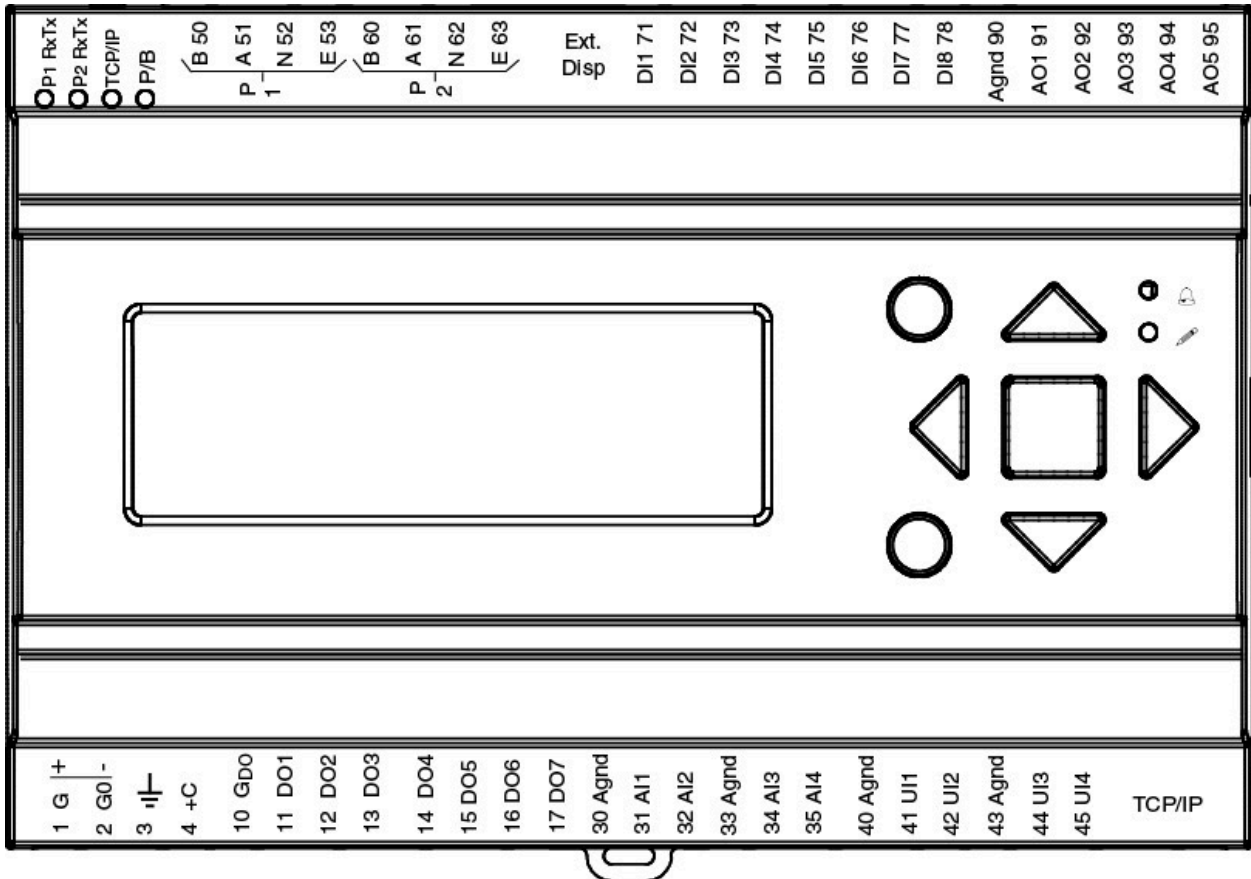

Figure 6-1 Corrigo Ardo



Caution! Before removing the controller from the terminal block, be sure to switch off the supply voltage.



Caution! It is important to ensure that the wiring is performed correctly and in accordance with the instructions given in this manual.

Wiring examples Corrigo Ardo

For a complete list of terminals, see *Appendix E Terminal lists*

The pictures below show examples for 24 V Corrigo Ardo

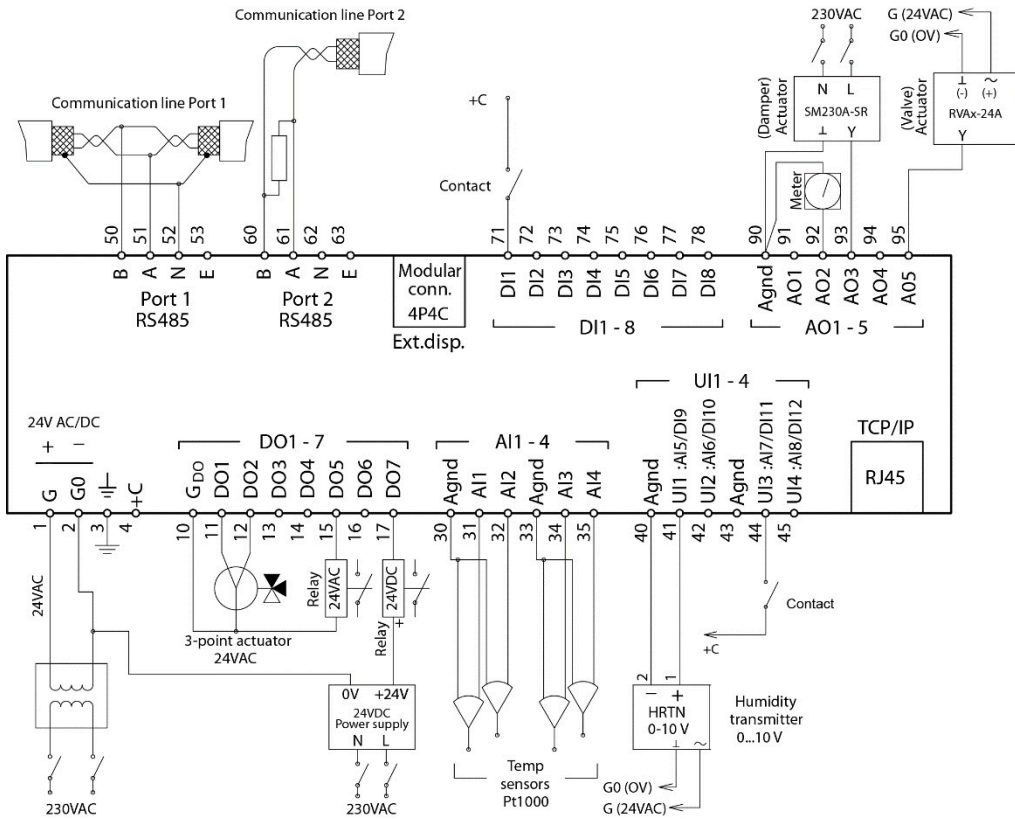

Figure 6-2 Wiring example

Inputs and outputs 24 V Corrigo Ardo

There is a list of input and outputs in *Appendix C Input and output lists* that can be used to help you keep track of which inputs and outputs you need to configure.

Analog inputs

Analogue inputs must refer to an **Agnd** terminal.

Analogue inputs can, depending on the configuration, be used for either PT1000 / Ni1000 temperature sensors or for 0...10 V DC analogue input signals, for example from a pressure transmitter.

Digital inputs

Digital inputs must refer to **+C** on terminal 4. Digital inputs may only be wired to voltage-free contacts. Any external voltage applied to a digital input may harm the unit.

Universal inputs

A universal input can be configured to act as either an analogue input or as a digital input.

A universal input configured as an analogue input can, depending on the configuration, be used for either PT1000 / Ni1000 temperature sensors or for 0...10 V DC analogue input signals, for example from a pressure transmitter.

Universal inputs configured as an analogue input must refer to an **Agnd** terminal.

A universal input configured as a digital input must, just like other digital inputs refer to **C+** on terminal 4. It may only be wired to voltage-free contacts.

Analog outputs

Analogue outputs must refer to a Agnd terminal.

All analogue outputs can be individually set to any one of the following output signals:

- ✓ 0...10 V DC
- ✓ 2...10 V DC
- ✓ 10...0 V DC
- ✓ 10...2 V DC



Caution! If the controller and its connected actuators share the same transformer, it is essential that the same transformer pole is used as reference for all the equipment. The equipment may otherwise not function as intended and may also suffer damages.

Digital outputs

Digital outputs should normally refer to G_{DO} on terminal 10. G_{DO} is internally connected to G on terminal 1 and supplies 24 V AC or DC depending on the choice of supply voltage.

All the digital outputs are controlled by MOSFET transistors. The outputs are internally connected with G_0 and can deliver max 2 A per output. However, the total power for all the DOs must not exceed 8 A.

A number of different wiring alternatives are possible depending on the type of supply voltage to the controller and the relay type.

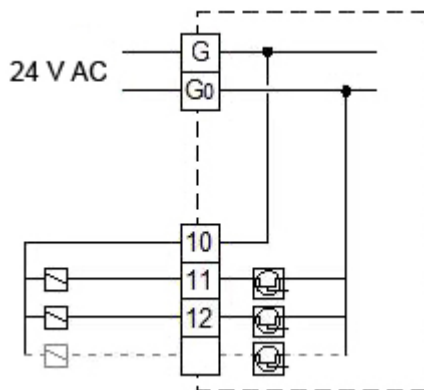

Figure 6-3 24 V AC supply and 24 V AC relays

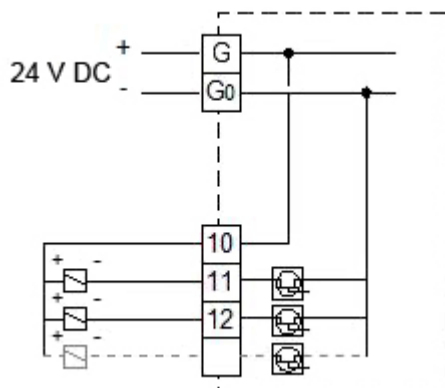

Figure 6-4 24 V DC supply and 24 V DC relays

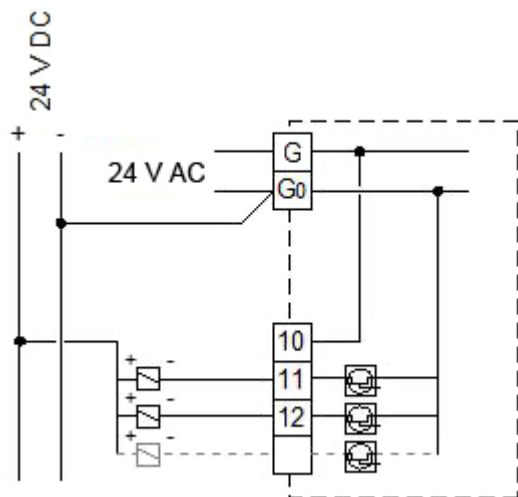

Figure 6-5 24 V AC supply and 24 V DC relays

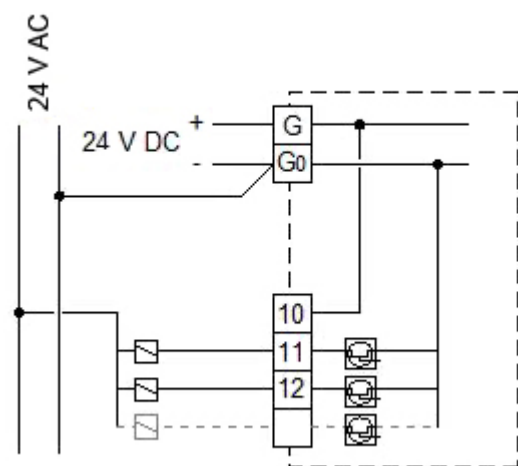

Figure 6-6 24 V DC supply and 24 V AC relays

6.1.2 Corrigo Vido (230 V)

The controller can be mounted in a DIN-standard casing (minimum 9 modules), on a DIN-rail in a cabinet or, using a suitable front-mounting kit, in a cabinet door or other control panel. The 230 V (Corrigo Vido) models can also be mounted directly on a wall.

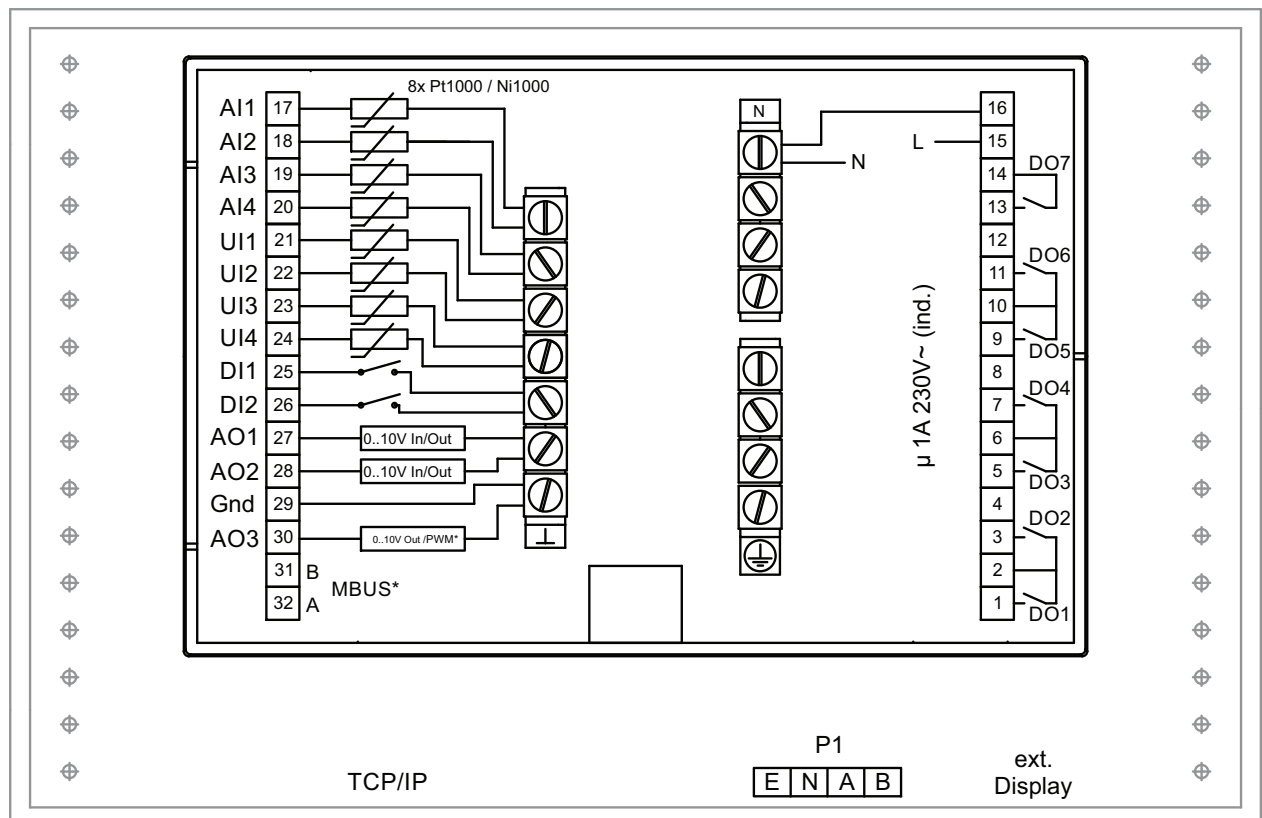

Figure 6-7 Corrigo Vido

* Depending on model



Caution! Before removing the controller from the terminal block, be sure to switch off the supply voltage.



Caution! It is important to ensure that the wiring is performed correctly and in accordance with the instructions given in this manual.

Inputs and outputs 230 V Corrigo Vido models

There is a list of input and outputs in *Appendix C Input and output lists* that can be used to help you keep track of which inputs and outputs you need to configure.

Analog inputs

Analog inputs must refer to a ground, Gnd, terminal.

Analog inputs are intended for use with PT1000 / Ni1000 sensors as a temperature sensor.

Digital inputs

Digital inputs must refer to a ground, Gnd, terminal.

Universal inputs

A universal input can be configured to act as either an analogue input or as a digital input.

A universal input configured as an analogue input can be used with PT1000 / Ni1000 temperature sensors.

A universal input configured as an analogue input must refer to a ground, Gnd, terminal.

A universal input configured as a digital input must refer to a ground, Gnd, terminal.

Universal analog

Universal analog I/O:s can be configured as either analog inputs or analog outputs.

Analog outputs must refer to a ground, Gnd, terminal. The outputs can be individually set to any one of the following output signals:

- ✓ 0...10 V DC
- ✓ 2...10 V DC
- ✓ 10...0 V DC
- ✓ 10...2 V DC

Digital outputs

The relays are voltage-free and must receive power from a single pole for each relay.

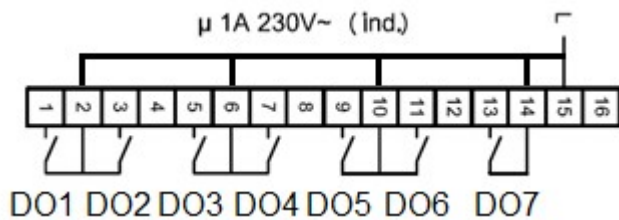

Figure 6-8

6.1.3 Expansion units EXOline

The communication between master and expansion units takes place via EXOline. The slave units will be assigned the address 241:1 and 241:2 during initialisation (PLA:ELA).

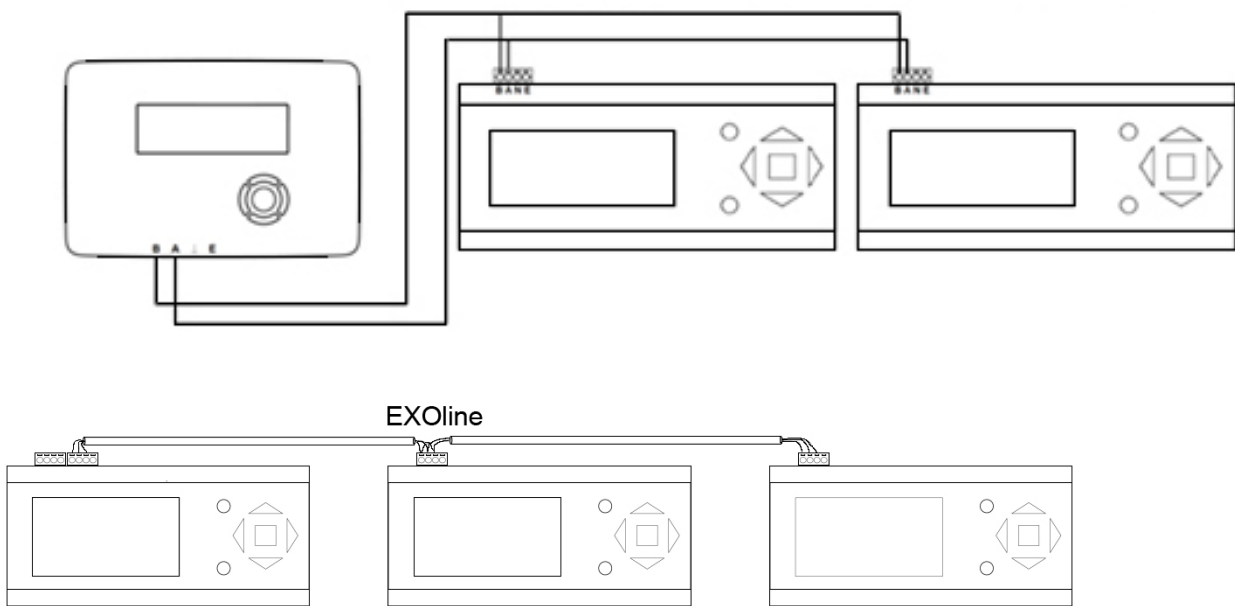

Figure 6-9 Expansion units EXOline

6.2 Commissioning

Before the controller can be used, inputs and outputs as well as a number of parameters must be configured.

All configuring must be done in Application tool that can be downloaded from <http://www.regincontrols.com> or in the web interface.

6.2.1 Configuration using Application tool

Application tool is a PC-based, free configuration software tool, available at Regin's website www.regincontrols.com. The tool is used to configure and commission the controller.

The controller doesn't need to be connected to the computer while configuring. All settings are made in the tool and then uploaded to the controller.

An infinite number of configurations can be stored in the computer memory for later use.

A communication cable is required in order to upload the configuration to the controller. The controller must also be powered up and the application selected in order for it to be configured.

Predefined configurations can be downloaded as atf-files from Regin's website, www.regincontrols.com. These atf-files can be opened in the tool and synchronized to the controller.

6.2.2 Configuration in the web interface

When the Corrigo is connected to an external display or computer with a browser and a connection to the internet, an internal web interface will be shown. The web interface can be used to configure, change setpoints, and monitor the controller.

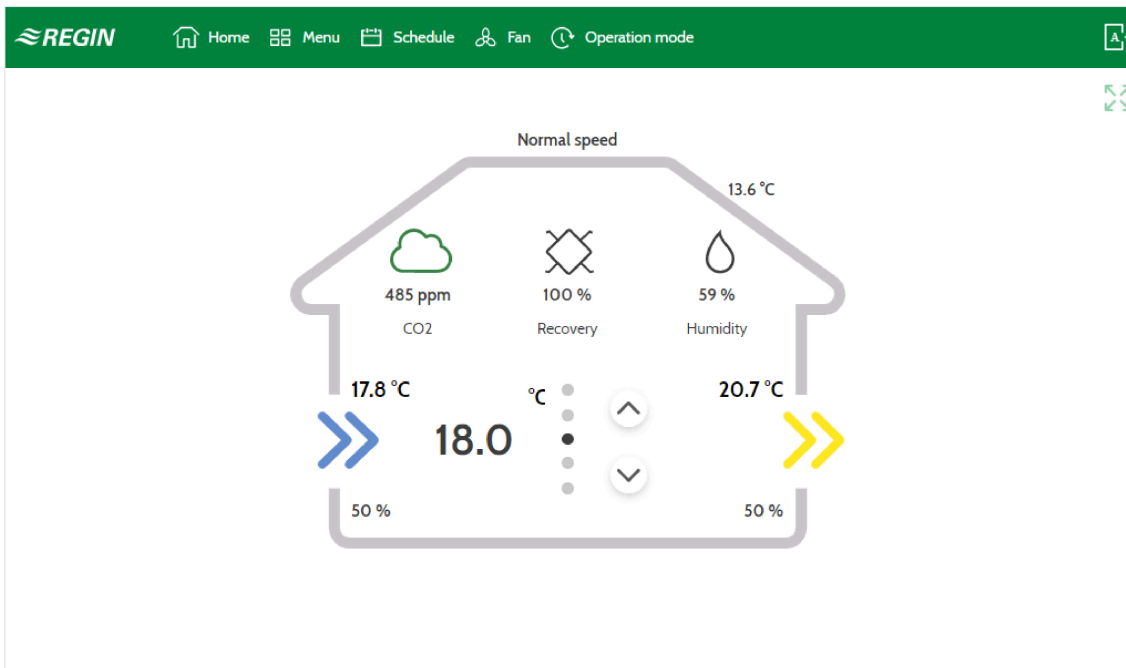

Figure 6-10 Start screen for the web interface

6.3 Loading the application

Reset the controller by pressing the reset button, using for example a paper clip.

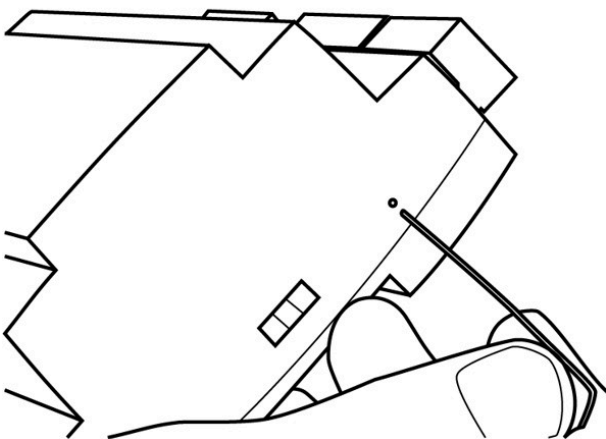

Figure 6-11 Resetting the controller

Load the application into the controller and commission. The application is loaded from Application tool.

In Application tool, go to the *Tools* menu at the top and select *Reload controller*.



Note! The controller and the computer need to be in the same network.

Appendix A Technical data

A.1 Corrigo Ardo

A.1.1 General data

Supply voltage	24 V AC (21...27 V AC 50...60 Hz / 20...36 V DC)
Power consumption	See <i>Table B-2</i> in <i>Appendix B Model overview</i>
Ambient temperature	0...50 °C
Ambient humidity	Max. 95 % RH
Storage temperature	-20...70 °C
Protection class	IP20
Connection	Disconnectable terminal strips, 4 mm ²
Memory backup	Built-in long life battery gives long backup time of all settings incl. real time
Display	Backlit LCD, 4 rows of 20 characters
Mounting	DIN-rail or cabinet
Casing	Standard Euronorm (8.5 modules wide)
Dimensions (WxHxD)	149 x 121 x 60 mm incl. terminals
Battery type	CR2032 replaceable Lithium cell
Battery life	Min. 5 years
Operating system	EXOrealC

A.1.2 Communication ports

TCP/IP	EXOline, Modbus, BACnet/IP, CLOUDigo
RS485	EXOline, Modbus, BACnet MS/TP

A.1.3 Inputs & Outputs

Analog inputs (AI)	For PT1000, Ni1000, Ni1000LG sensors (accuracy ± 0.4 °C) or 0...10 V DC (accuracy ± 0.15 % of full output signal). 12 bit resolution in the A/D conversion.
Digital inputs (DI)	For potential-free contacts
Universal inputs (UI)	Can be set to act as either analog input or digital input with specifications as above
Analog outputs (AO)	0...10 V DC, 5 mA, short-circuit protected
Digital outputs (DO)	Mosfet outputs, 24 V AC or DC, 2 A continuous. Max. 8 A in total.

A.2 Corrigo Vido

A.2.1 General data

Supply voltage	85...265 V AC, 50/60 Hz
Power consumption	See <i>Table B-4</i> in <i>Appendix B Model overview</i>
Ambient temperature	0...50 °C
Ambient humidity	Max. 95 % RH
Storage temperature	-20...70 °C
Protection class	IP20, IP40 when mounted in cabinet
Memory backup	Built-in long life battery gives long backup time of all settings incl. real time
Display	Backlit LCD, 4 rows of 20 characters
Mounting	DIN-rail, cabinet or on wall
Dimensions (WxHxD)	146.7 x 97.6 x 76.0 mm incl. terminals
Battery type	CR2032 replaceable Lithium cell
Battery life	Min. 8 years
Operating system	EXOrealC

A.2.2 Communication ports

TCP/IP	EXOline, Modbus, BACnet/IP, CLOUDigo
RS485	EXOline, Modbus, BACnet MS/TP

A.2.3 Inputs & Outputs

Analog inputs (AI)	For PT1000, Ni1000, Ni1000LG sensors. 12 bit resolution in the A/D conversion.
Digital inputs (DI)	For potential-free contacts
Universal inputs (UI)	Can be set to act as either analogue input or digital input with specifications as above
Analog inputs/outputs (UA)	Configurable as output (0...10 V DC, 2...10 V DC, 10...0 V DC or 10...2 V DC, 8 bit D/A (short-circuit protected) or input (0...10 V DC)
Digital outputs (DO)	7x relay, 230 V AC, 1 A load per relay, max 7 A total

Appendix B Model overview

B.1 Corrigo Ardo - Model overview

Table B-1 Corrigo Ardo and Expansion units (24 V)

Name	Voltage	Description
VCA152DW-4 VCA152W-4	24 V	Ardo Controller with one RS485 port and one TCP/IP port
VCA283DW-4 VCA283W-4	24 V	Ardo Controller with two RS485 ports and one TCP/IP port
IO-A15MIXW-3-BEM IO-A19MIXW-1-BEM IO-A28MIXW-3-BEM	24 V	Ardo Expansion unit with one RS485 port

Table B-2 Corrigo Ardo inputs, outputs, ports, display, power consumption

Name	AI	DI	UI*	AO	DO	RS485 ports	TCP/IP ports	M-Bus ports	Display	Power consumption (VA)
VCA152DW-4	4	4	-	3	4	1	1	-	✓	9
VCA152W-4	4	4	-	3	4	1	1	-	-	5
VCA283DW-4	4	8	4	5	7	2	1	-	✓	9
VCA283W-4	4	8	4	5	7	2	1	-	-	5
IO-A15MIXW-3-BEM	4	4	-	3	4	1	1	-	-	5
IO-AV19MIXW-1-BEM	4	2	4	2**	7	1	1	-	-	7.5
IO-A28MIXW-3-BEM	4	8	4	5	7	1	1	-	-	5

* Universal inputs can be configured to function as either analog or digital outputs.

** Universal analog that can be configured to function as either analog inputs or analog outputs (0...10 V DC).

B.2 Corrigo Vido - Model overview

Table B-3 Corrigo Vido and expansion unit (230 V)

Name	Voltage	Description
VCV203DW-2	230 V	Vido Controller with one RS485 port and one TCP/IP port
IO-A15MiXW-3-BEM IO-V19MIXW-1-BEM IO-A28MIXW-3-BEM	230 V	Vido Expansion unit with one RS485 port

Table B-4 Corrigo Vido inputs, outputs, ports, display, power consumption

Name	AI	DI	UI*	AO	DO	RS485 ports	TCP/IP ports	M-Bus ports	Display	Power consumption (VA)
VCV203DW-2	4	2	4	2**	7	1	1	-	✓	11
IO-A15MiXW-3-BEM	4	4	-	3	4	1	1	-	-	5
IO-V19MIXW-1-BEM	4	2	4	2**	7	1	1	-	-	7.5
IO-A28MIXW-3-BEM	4	8	4	5	7	1	1	-	-	5

* Universal inputs can be configured to function as either analogue or digital outputs.

** Universal analogue that can be configured to function as either analogue inputs or analogue outputs (0...10 V DC).

Appendix C Input and output lists

The lists below are intended to be used as a memory aid during configuration, in order to help keep track of the desired input and output functions.

The left column contains the name of the in-/output signal, the middle column displays the name of the corresponding signal in Application tool and the right column shows the text displayed in the controller.

C.1 Analog inputs

✓	Name	Name in Application tool	Description
	Outdoor temperature sensor	Outdoor temperature	
	Intake air temperature sensor	Intake air temperature	
	Supply air temperature sensor	Supply air temperature	
	Exhaust air temperature sensor	Exhaust air temperature	
	Extract air temperature sensor	Extract air temperature	
	Room temperature sensor 1	Room temperature 1	
	Room temperature sensor 2	Room temperature 2	
	Room temperature sensor 3	Room temperature 3	
	Room temperature sensor 4	Room temperature 4	
	Room temperature sensor 5	Room temperature 5	
	Room temperature sensor 6	Room temperature 6	
	Room temperature sensor 7	Room temperature 7	
	Room temperature sensor 8	Room temperature 8	
	Room temperature sensor 9	Room temperature 9	
	Room temperature sensor 10	Room temperature 10	
	Room temperature sensor 11	Room temperature 11	
	Room temperature sensor 12	Room temperature 12	
	Room temperature sensor 13	Room temperature 13	
	Room temperature sensor 14	Room temperature 14	
	Room temperature sensor 15	Room temperature 15	
	Room temperature sensor 16	Room temperature 16	
	Pressure transmitter supply air	Pressure supply air	
	Pressure transmitter extract air	Pressure extract air	
	Flow transmitter supply air	Flow supply air	
	Flow transmitter extract air	Flow extract air	
	Flow transmitter exchanger supply air	Flow exchanger supply air	
	Exchanger EAF pressure transmitter	Pressure exchanger extract air	
	De-icing temperature heat exchanger	Defrosting temperature	
	Frost protection temperature sensor 1	Freeze protection temperature 1	
	Frost protection temperature sensor 2	Freeze protection temperature 2	
	Frost protection temperature sensor 3	Freeze protection temperature 3	
	CO2/VOC sensor	CO2 room/extract air	
	Room humidity transmitter (% RH)	Humidity room/extract air	
	Supply air humidity transmitter (% RH)	Humidity supply air	
	Outdoor air humidity transmitter (% RH)	Humidity outdoor	
	Temperature extra controller	Extra controller temperature	

Input and output lists

✓	Name	Name in Application tool	Description
	External control signal SAF (%)	External control supply air fan	
	External control signal EAF (%)	External control extract air fan	
	Extra sensor 1	Extra sensor 1	
	Extra sensor 2	Extra sensor 2	
	Extra sensor 3	Extra sensor 3	
	Extra sensor 4	Extra sensor 4	
	Extra sensor 5	Extra sensor 5	
	External supply setpoint (PT1000)	External setpoint temperature	
	External Setpoint airflow (m3/h)	External setpoint flow	
	Filter supply pressure transmitter	Pressure filter supply air	
	Filter extract pressure transmitter	Pressure filter extract air	
	Efficiency temperature sensor exchanger	Efficiency temperature exchanger	

C.2 Digital inputs

✓	Name	Name in Application tool	Description
	Supply air fan motor protection/run indication	Feedback supply air fan	
	Extract air fan motor protection/run indication	Feedback extract air fan	
	Extended operation low speed	Extended operation low speed	
	Extended operation normal speed	Extended operation normal speed	
	Extended operation high speed	Extended operation high speed	
	Fire alarm	Fire alarm	
	Smoke alarm	Smoke alarm	
	External alarm	External alarm	
	Fire damper end-switch monitoring	Feedback fire damper	
	Feedback/Indication Sequence A	Feedback sequence A	
	Feedback/Indication Sequence B	Feedback sequence B	
	Feedback/Indication Sequence C	Feedback sequence C	
	Feedback/Indication Sequence D	Feedback sequence D	
	Feedback/Indication Sequence E	Feedback sequence E	
	Feedback/Indication Sequence F	Feedback sequence F	
	Feedback/Indication Sequence G	Feedback sequence G	
	Feedback/Indication Sequence H	Feedback sequence H	
	Feedback/Indication Sequence I	Feedback sequence I	
	Feedback/Indication Sequence J	Feedback sequence J	
	Electric heating is overheated	Overheated electric heater	
	External stop	External stop	
	Acknowledge all alarms	Alarm acknowledgement	
	Flow switch	Flow guard	
	De-icing exchanger	Defrosting guard exchanger	
	Rotation exchanger	Rotary exchanger alarm	
	Frost protection thermostat	Freeze protection guard	
	Start Recirculation Run	Start/(Stop) recirculation	
	Changeover signal 1, switches between heating=0 and cooling=1 on the output signal	Cooling/(Heating) Changeover 1	

✓	Name	Name in Application tool	Description
	Changeover signal 2, switches between heating=0 and cooling=1 on the output signal	Cooling/(Heating) Changeover 2	
	Filter guard 1 supply air	Filter guard supply air	
	Filter guard 2 extract air	Filter guard extract air	
	Motor control 1 start	Start/(Stop) extra fan motor 1	
	Motor control 2 start	Start/(Stop) extra fan motor 2	
	Motor control 1 protection/run indication	Feedback extra fan motor 1	
	Motor control 2 protection/run indication	Feedback extra fan motor 2	
	Extra alarm 1	Extra alarm 1	
	Extra alarm 2	Extra alarm 2	
	Extra alarm 3	Extra alarm 3	
	Extra alarm 4	Extra alarm 4	
	Extra alarm 5	Extra alarm 5	
	Extra alarm 6	Extra alarm 6	
	Extra alarm 7	Extra alarm 7	
	Extra alarm 8	Extra alarm 8	
	Extra alarm 9	Extra alarm 9	
	Extra alarm 10	Extra alarm 10	
	Freeze supply PID	Lock PID controller supply	
	Summer mode	Summer/(Winter) mode	
	Feedback/Indication extra controller	Feedback extra controller	
	Changeover 1 alarm	Changeover 1 alarm	
	Changeover 1 defrost	Changeover 1 defrost	
	Changeover 1 run indication	Changeover 1 run indication	

C.3 Universal inputs

Universal inputs on the controller can be individually configured as either analog inputs, using any of the analog input signals above, or as digital inputs, using any of the digital inputs above.

C.4 Analog outputs

✓	Name	Name in Application tool	Description
	Sequence A output in (%)	Sequence A	
	Sequence B output in (%)	Sequence B	
	Sequence C output in (%)	Sequence C	
	Sequence D output in (%)	Sequence D	
	Sequence E output in (%)	Sequence E	
	Sequence F output in (%)	Sequence F	
	Sequence G output in (%)	Sequence G	
	Sequence H output in (%)	Sequence H	
	Sequence I output in (%)	Sequence I	
	Sequence J output in (%)	Sequence J	
	Changeover 1 (%)	Changeover 1	

✓	Name	Name in Application tool	Description
	Changeover 2 (%)	Changeover 2	
	Control signal Supply air fan in (%)	Supply air fan	
	Control signal Extract air fan in (%)	Extract air fan	
	Control valve Humidity (%)	Humidity control	
	Step Controller 1 (%)	Step controller 1	
	Step Controller 2 (%)	Step controller 2	
	Extra controller (%)	Extra controller	
	AI Signal output (%)	Temperature output	

C.5 Digital outputs

✓	Name	Name in Application tool	Description
	Sequence A Start	Sequence A start	
	Sequence B Start	Sequence B start	
	Sequence C Start	Sequence C start	
	Sequence D Start	Sequence D start	
	Sequence E Start	Sequence E start	
	Sequence F Start	Sequence F start	
	Sequence G Start	Sequence G start	
	Sequence H Start	Sequence H start	
	Sequence I Start	Sequence I start	
	Sequence J Start	Sequence J start	
	Sequence A Pump Start	Sequence A pump	
	Sequence B Pump Start	Sequence B pump	
	Sequence C Pump Start	Sequence C pump	
	Sequence D Pump Start	Sequence D pump	
	Sequence E Pump Start	Sequence E pump	
	Sequence F Pump Start	Sequence F pump	
	Sequence G Pump Start	Sequence G pump	
	Sequence H Pump Start	Sequence H pump	
	Sequence I Pump Start	Sequence I pump	
	Sequence J Pump Start	Sequence J pump	
	Sequence A PWM	Sequence A PWM	
	Sequence B PWM	Sequence B PWM	
	Sequence C PWM	Sequence C PWM	
	Sequence D PWM	Sequence D PWM	
	Sequence E PWM	Sequence E PWM	
	Sequence F PWM	Sequence F PWM	
	Sequence G PWM	Sequence G PWM	
	Sequence H PWM	Sequence H PWM	
	Sequence I PWM	Sequence I PWM	
	Sequence J PWM	Sequence J PWM	
	Sequence A actuator increase	Sequence A increase	

✓	Name	Name in Application tool	Description
	Sequence B actuator increase	Sequence B increase	
	Sequence C actuator increase	Sequence C increase	
	Sequence D actuator increase	Sequence D increase	
	Sequence E actuator increase	Sequence E increase	
	Sequence F actuator increase	Sequence F increase	
	Sequence G actuator increase	Sequence G increase	
	Sequence H actuator increase	Sequence H increase	
	Sequence I actuator increase	Sequence I increase	
	Sequence J actuator increase	Sequence J increase	
	Sequence A actuator decrease	Sequence A decrease	
	Sequence B actuator decrease	Sequence B decrease	
	Sequence C actuator decrease	Sequence C decrease	
	Sequence D actuator decrease	Sequence D decrease	
	Sequence E actuator decrease	Sequence E decrease	
	Sequence F actuator decrease	Sequence F decrease	
	Sequence G actuator decrease	Sequence G decrease	
	Sequence H actuator decrease	Sequence H decrease	
	Sequence I actuator decrease	Sequence I decrease	
	Sequence J actuator decrease	Sequence J decrease	
	Start supply air fan/Start step 1 supply air fan	Supply air fan start/step 1	
	Start step 2 supply air fan	Supply air fan step 2	
	Start step 3 supply air fan	Supply air fan step 3	
	Start extract air fan/ Start step 1 extract air fan	Extract air fan start/step 1	
	Start step 2 extract air fan	Extract air fan step 2	
	Start step 3 extract air fan	Extract air fan step 3	
	Recirculation air close-off damper	Recirculation air damper	
	Outdoor air close-off damper	Outdoor air damper	
	Exhaust air close-off damper	Exhaust air damper	
	open/close fire dampers	Fire damper	
	Sum alarm 1	Sum alarm 1	
	Sum alarm 2	Sum alarm 2	
	Alarm output	Alarm output	
	Start motor control 1	Extra fan motor 1 start	
	Start motor control 2	Extra fan motor 2 start	
	Time Channel 1	Extra time channel 1	
	Time Channel 2	Extra time channel 2	
	Time Channel 3	Extra time channel 3	
	Time Channel 4	Extra time channel 4	
	Free Cool Run	Free cooling indication	
	Pretreatment	Pretreatment start	
	Run indication	Running indication	
	Step Controller 1 output step 1	Step controller 1 step 1	
	Step Controller 1 output step 2	Step controller 1 step 2	
	Step Controller 1 output step 3	Step controller 1 step 3	
	Step Controller 1 output step 4	Step controller 1 step 4	

Input and output lists

✓	Name	Name in Application tool	Description
	Step Controller 2 output step 1	Step controller 2 step 1	
	Step Controller 2 output step 2	Step controller 2 step 2	
	Step Controller 2 output step 3	Step controller 2 step 3	
	Step Controller 2 output step 4	Step controller 2 step 4	
	Start Dehumidifier/Humidifier	Humidify control start	
	Start Changeover 1	Changeover 1 (Changeover 1 start)	
	Start Changeover 2	Changeover 2 (Changeover 2 start)	
	Outdoor temperature controlled Exchanger	Outdoor controlled exchanger	
	Start Extra control unit	Extra controller start	
	Extra controller pump start	Extra controller pump	
	Changing changeover 1 between heat/cool	Changeover 1 heat/cool	
	Changing changeover 2 between heat/cool	Changeover 2 heat/cool	

Appendix D Alarm list

The alarm text, priority and delay columns show the factory set values.

D.1

No	Alarm text	Prio	Delay	Limit	Default action	Description
1	Malfunction supply air fan 1	B	120 s			Malfunction supply air fan 1
2	Malfunction supply air fan 2	B	120 s			Malfunction supply air fan 2
3	Malfunction supply air fan 3	B	120 s			Malfunction supply air fan 3
4	Malfunction supply air fan 4	B	120 s			Malfunction supply air fan 4
5	Malfunction supply air fan 5	B	120 s			Malfunction supply air fan 5
6	Malfunction extract air fan 1	B	120 s			Malfunction extract air fan 1
7	Malfunction extract air fan 2	B	120 s			Malfunction extract air fan 2
8	Malfunction extract air fan 3	B	120 s			Malfunction extract air fan 3
9	Malfunction extract air fan 4	B	120 s			Malfunction extract air fan 4
10	Malfunction extract air fan 5	B	120 s			Malfunction extract air fan 5
11	Alarm supply air fan 1	A	0 s			Alarm from frequency converter SAF via Modbus communication
12	Alarm supply air fan 2	A	0 s			Alarm from frequency converter SAF 2 via Modbus communication
13	Alarm supply air fan 3	A	0 s			Alarm from frequency converter SAF 3 via Modbus communication
14	Alarm supply air fan 4	A	0 s			Alarm from frequency converter SAF 4 via Modbus communication
15	Alarm supply air fan 5	A	0 s			Alarm from frequency converter SAF 5 via Modbus communication
16	Alarm extract air fan 1	A	0 s			Alarm from frequency converter EAF 1 via Modbus communication
17	Alarm extract air fan 2	A	0 s			Alarm from frequency converter EAF 2 via Modbus communication
18	Alarm extract air fan 3	A	0 s			Alarm from frequency converter EAF 3 via Modbus communication
19	Alarm extract air fan 4	A	0 s			Alarm from frequency converter EAF 4 via Modbus communication
20	Alarm extract air fan 5	A	0 s			Alarm from frequency converter EAF 5 via Modbus communication
21	Warning supply air fan 1	C	0 s			Warning from frequency converter SAF 1 via Modbus communication
22	Warning supply air fan 2	C	0 s			Warning from frequency converter SAF 2 via Modbus communication
23	Warning supply air fan 3	C	0 s			Warning from frequency converter SAF 3 via Modbus communication

Alarm list

No	Alarm text	Prio	Delay	Limit	Default action	Description
24	Warning supply air fan 4	C	0 s			Warning from frequency converter SAF 4 via Modbus communication
25	Warning supply air fan 5	C	0 s			Warning from frequency converter SAF 5 via Modbus communication
26	Warning extract air fan 1	C	0 s			Warning from frequency converter EAF 1 via Modbus communication
27	Warning extract air fan 2	C	0 s			Warning from frequency converter EAF 2 via Modbus communication
28	Warning extract air fan 3	C	0 s			Warning from frequency converter EAF 3 via Modbus communication
29	Warning extract air fan 4	C	0 s			Warning from frequency converter EAF 4 via Modbus communication
30	Warning extract air fan 5	C	0 s			Warning from frequency converter EAF 5 via Modbus communication
31	External operation supply air fan	C	120 s			SAF run-signal received when unit is stopped
32	External operation extract air fan	C	120 s			EAF run-signal received when unit is stopped
33	Extra fan motor 1 running	-	120 s			External operation of motor control 1
34	Extra fan motor 2 running	-	120 s			External operation of motor control 2
35	Malfunction pump heater	B	5 s			Malfunction pump, heating circuit
36	Malfunction pump cooler	B	5 s			Malfunction pump, cooling circuit
37	Malfunction pump exchanger	B	20 s			Malfunction pump, liquid connected exchanger
38	Malfunction fire damper	B	5 s			Fire damper exercise test failed
39	Malfunction damper	B	90 s			Malfunction damper (via Modbus)
40	Malfunction extra fan motor 1	-	120 s			Malfunction in extra fan motor control 1
41	Malfunction extra fan motor 2	-	120 s			Malfunction in extra fan motor control 2
42	Testing fire damper	C	0 s		Normal stop	The unit is stopped due to exercise on fire damper.
43	Malfunction sequence A	-	5 s			Malfunction sequence A
44	Malfunction sequence B	-	5 s			Malfunction sequence B
45	Malfunction sequence C	-	5 s			Malfunction sequence C
46	Malfunction sequence D	-	5 s			Malfunction sequence D
47	Malfunction sequence E	-	5 s			Malfunction sequence E
48	Malfunction sequence F	-	5 s			Malfunction sequence F
49	Malfunction sequence G	-	5 s			Malfunction sequence G
50	Malfunction sequence H	-	5 s			Malfunction sequence H
51	Malfunction sequence I	-	5 s			Malfunction sequence I
52	Malfunction sequence J	-	5 s			Malfunction sequence J

No	Alarm text	Prio	Delay	Limit	Default action	Description
53	Filter alarm supply air	B	180 s	CURVE		Filter alarm supply air pressure switch or analogue filter switch activated. The analogue filter switch may be flow dependent.
54	Filter alarm extract air	B	180 s	CURVE		Filter alarm extract air pressure switch or analogue filter switch activated. The analogue filter switch may be flow dependent.
55	Alarm low air flow	B	5 s		Normal stop	Flow switch activated
56	Freeze protection guard	A	0 s		Fast stop	External frost protection thermostat activated
57	Defrosting guard exchanger	-	0 s			Exchanger deicing pressure switch activated
58	Fire alarm	A	0 s		Fast stop	Fire alarm activated
59	Smoke alarm	A	0 s		Fast stop	Smoke detector activated
60	External stop	C	0 s		Normal stop	"External stop" activated
61	External alarm	B	0 s			External alarm activated
62	Service stop	B	0 s		Normal stop	Service stop activated
63	Electric heating is overheated	A	0 s		Normal stop	Heater high temperature limit switch activated
64	Warning freeze protection	B	0 s			Frost protection function is overriding the control of the heater output
65	Low efficiency exchanger	B	30 min	50 %		Heat exchanger efficiency below limit value
66	Defrosting alarm	-	2 s			Exchanger deicing activated by deicing sensor
67	Rotary exchanger alarm	B	20 s			Exchanger rotation guard alarm
68	Extra alarm 1	-	0 s			Extra alarm 1 on digital input
69	Extra alarm 2	-	0 s			Extra alarm 2 on digital input
70	Extra alarm 3	-	0 s			Extra alarm 3 on digital input
71	Extra alarm 4	-	0 s			Extra alarm 4 on digital input
72	Extra alarm 5	-	0 s			Extra alarm 5 on digital input
73	Extra alarm 6	-	0 s			Extra alarm 6 on digital input
74	Extra alarm 7	-	0 s			Extra alarm 7 on digital input
75	Extra alarm 8	-	0 s			Extra alarm 8 on digital input
76	Extra alarm 9	-	0 s			Extra alarm 9 on digital input
77	Extra alarm 10	-	0 s			Extra alarm 10 on digital input
78	Internal battery error	A	0 s			Internal battery needs replacing
79	Alarm service interval	C	0 s			Time for service
80	Restart blocked after power on	B	0 s		Fast stop	Restart blocked due to earlier power failure
81	Deviation alarm supply air temp.	B	30 min	10 °C		Supply air temp deviates too much from the setpoint
82	Deviation alarm supply air fan	-	30 min	50 Pa		Supply air pressure deviates too much from the setpoint
83	Deviation alarm extract air fan	-	30 min	50 Pa		Extract air pressure deviates too much from the setpoint
84	Deviation alarm humidity control	-	30 min	10 %		The room humidity deviates too much from the setpoint
85	Deviation alarm extra controller	-	30 min	10 °C		Extra unit temp deviates too much from the setpoint

Alarm list

No	Alarm text	Prio	Delay	Limit	Default action	Description
86	High supply air temperature	B	5 s	30 °C		Supply air temp too high
87	Low supply air temperature	B	5 s	10 °C		Supply air temp too low
88	Supply air temperature max limit	-	0 s			Maximum limiting of supply air temp active
89	Supply air temperature min limit	-	0 s			Minimum limiting of supply air temp active
90	High room temperature	B	30 min	30 °C		Room temp too high during room temp control
91	Low room temperature	B	30 min	10 °C		Room temp too low during room temp control
92	High extract air temperature	B	30 min	30 °C		High extract air temp during extract air control
93	Low extract air temperature	B	30 min	10 °C		Low extract air temp during extract air control
94	High outdoor air temperature	-	0 min	40 °C		Outdoor temperature is too high
95	Low outdoor air temperature	-	0 min	-30 °C		Outdoor temperature is too low
96	Freeze protection alarm 1	A	0 s		Fast stop	Frost protection temperature 1 below frost limit value
97	Freeze protection alarm 2	A	0 s		Fast stop	Frost protection temperature 2 below frost limit value
98	Freeze protection alarm 3	A	0 s		Fast stop	Frost protection temperature 3 below frost limit value
99	High temperature extra sensor 1	-	0 min	30 °C		High temperature extra sensor 1
100	Low temperature extra sensor 1	-	0 min	10 °C		Low temperature extra sensor 1
101	High temperature extra sensor 2	-	0 min	30 °C		High temperature extra sensor 2
102	Low temperature extra sensor 2	-	0 min	10 °C		Low temperature extra sensor 2
103	High temperature extra sensor 3	-	0 min	30 °C		High temperature extra sensor 3
104	Low temperature extra sensor 3	-	0 min	10 °C		Low temperature extra sensor 3
105	High temperature extra sensor 4	-	0 min	30 °C		High temperature extra sensor 4
106	Low temperature extra sensor 4	-	0 min	10 °C		Low temperature extra sensor 4
107	High temperature extra sensor 5	-	0 min	30 °C		High temperature extra sensor 5
108	Low temperature extra sensor 5	-	0 min	10 °C		Low temperature extra sensor 5
109	High temperature selected sensor 1	-	0 min	0 °C		High temperature 1 on selected sensor
110	Low temperature selected sensor 1	-	0 min	0 °C		Low temperature 1 on selected sensor
111	High temperature selected sensor 2	-	0 min	0 °C		High temperature 2 on selected sensor
112	Low temperature selected sensor 2	-	0 min	0 °C		Low temperature 2 on selected sensor
113	Manual operation air handling unit	C	0 s			The unit is in manual mode
114	Manual operation supply air	C	0 s			Supply air temp controller in manual control
115	Manual operation supply air fan	C	0 s			Supply air fan in manual control

No	Alarm text	Prio	Delay	Limit	Default action	Description
116	Manual operation extract air fan	C	0 s			Extract air fan in manual control
117	Manual operation heater	C	0 s			The heater is in manual mode
118	Manual operation exchanger	C	0 s			Heat exchanger output in manual control
119	Manual operation cooler	C	0 s			Cooling output in manual control
120	Manual operation damper	C	0 s			Damper output in manual control
121	Manual operation pump heater	C	0 s			Heating circulation pump in manual control
122	Manual operation pump exchanger	C	0 s			Exchanger circulation pump in manual control
123	Manual operation pump cooler	C	0 s			Cooling circulation pump in manual control
124	Manual operation damper recirc.	C	0 s			Recirculation air damper in manual control
125	Manual operation damper outdoor air	C	0 s			Fresh air damper in manual control
126	Manual operation damper exhaust air	C	0 s			Exhaust air damper in manual control
127	Manual operation fire damper	C	0 s			Fire dampers in manual control
128	Manual control sequence A	-	0 s			Manual control of sequence A
129	Manual control sequence B	-	0 s			Manual control of sequence B
130	Manual control sequence C	-	0 s			Manual control of sequence C
131	Manual control sequence D	-	0 s			Manual control of sequence D
132	Manual control sequence E	-	0 s			Manual control of sequence E
133	Manual control sequence F	-	0 s			Manual control of sequence F
134	Manual control sequence G	-	0 s			Manual control of sequence G
135	Manual control sequence H	-	0 s			Manual control of sequence H
136	Manual control sequence I	-	0 s			Manual control of sequence I
137	Manual control sequence J	-	0 s			Manual control of sequence J
138	Output in manual operation	C	0 s			Analogue or digital output in manual mode
139	Input in manual operation	C	0 s			Analogue or digital input in manual mode
140	Manual operation extra controller	C	0 s			Extra controller in manual mode
141	Manual operation ext. fan motor 1	C	0 s			Motor control 1 in manual mode
142	Manual operation ext. fan motor 2	C	0 s			Motor control 2 in manual mode
143	Manual operation pretreatment	C	0 s			Pretreatment in manual mode
144	Sensor error outdoor air temperature	B	5 s			Malfunction in connected sensor
145	Sensor error intake air temperature	B	5 s			Malfunction in connected sensor
146	Sensor error supply air temperature	B	5 s			Malfunction in connected sensor
147	Sensor error exhaust air temperature	B	5 s			Malfunction in connected sensor
148	Sensor error extract air temperature	B	5 s			Malfunction in connected sensor
149	Sensor error room temperature 1	B	5 s			Malfunction in connected sensor

Alarm list

No	Alarm text	Prio	Delay	Limit	Default action	Description
150	Sensor error room temperature 2	B	5 s			Malfunction in connected sensor
151	Sensor error room temperature 3	B	5 s			Malfunction in connected sensor
152	Sensor error room temperature 4	B	5 s			Malfunction in connected sensor
153	Sensor error room temperature 5	B	5 s			Malfunction in connected sensor
152	Sensor error room temperature 6	B	5 s			Malfunction in connected sensor
155	Sensor error room temperature 7	B	5 s			Malfunction in connected sensor
156	Sensor error room temperature 8	B	5 s			Malfunction in connected sensor
157	Sensor error room temperature 9	B	5 s			Malfunction in connected sensor
158	Sensor error room temperature 10	B	5 s			Malfunction in connected sensor
159	Sensor error room temperature 11	B	5 s			Malfunction in connected sensor
160	Sensor error room temperature 12	B	5 s			Malfunction in connected sensor
161	Sensor error room temperature 13	B	5 s			Malfunction in connected sensor
162	Sensor error room temperature 14	B	5 s			Malfunction in connected sensor
163	Sensor error room temperature 15	B	5 s			Malfunction in connected sensor
164	Sensor error room temperature 16	B	5 s			Malfunction in connected sensor
165	Sensor error pressure supply air	B	5 s			Malfunction in connected sensor
166	Sensor error pressure extract air	B	5 s			Malfunction in connected sensor
167	Sensor error flow supply air	B	5 s			Malfunction in connected sensor
168	Sensor error flow extract air	B	5 s			Malfunction in connected sensor
169	Sensor error flow exch. supply air	B	5 s			Malfunction in connected sensor
170	Sensor error press. exch. extr. air	B	5 s			Malfunction in connected sensor
171	Sensor error defrosting temperature	B	5 s			Malfunction in connected sensor
172	Sensor error freeze protect. temp. 1	B	5 s			Malfunction in connected sensor
173	Sensor error freeze protect. temp. 2	B	5 s			Malfunction in connected sensor
174	Sensor error freeze protect. temp. 3	B	5 s			Malfunction in connected sensor
175	Sensor error CO2 room/extract air	B	5 s			Malfunction in connected sensor
176	Sensor error humidity room/ extr. air	B	5 s			Malfunction in connected sensor
177	Sensor error humidity supply air	B	5 s			Malfunction in connected sensor
178	Sensor error humidity outdoor	B	5 s			Malfunction in connected sensor
179	Sensor error extra controller	B	5 s			Malfunction in connected sensor

No	Alarm text	Prio	Delay	Limit	Default action	Description
180	Signal error external control SAF	B	5 s			Malfunction in connected sensor
181	Signal error external control EAF	B	5 s			Malfunction in connected sensor
182	Sensor error extra sensor 1	B	5 s			Malfunction in connected sensor
183	Sensor error extra sensor 2	B	5 s			Malfunction in connected sensor
184	Sensor error extra sensor 3	B	5 s			Malfunction in connected sensor
185	Sensor error extra sensor 4	B	5 s			Malfunction in connected sensor
186	Sensor error extra sensor 5	B	5 s			Malfunction in connected sensor
187	Sensor error external temp. setpoint	B	5 s			Malfunction in connected sensor
188	Signal error external flow setpoint	B	5 s			Malfunction in connected sensor
189	Sensor error press. filter supp. air	B	5 s			Malfunction in connected sensor
190	Sensor error press. filter extr. air	B	5 s			Malfunction in connected sensor
191	Sensor error efficiency temp. exch.	B	5 s			Malfunction in connected sensor
192	Communication fault device	C	0 s			Communication error to a device
193	Malfunction extra controller	C	5 s			Malfunction in connected sensor
194	Internal error	C	60 s			Internal error

Appendix E Terminal lists

E.1 Corrigo Ardo (24 V models)

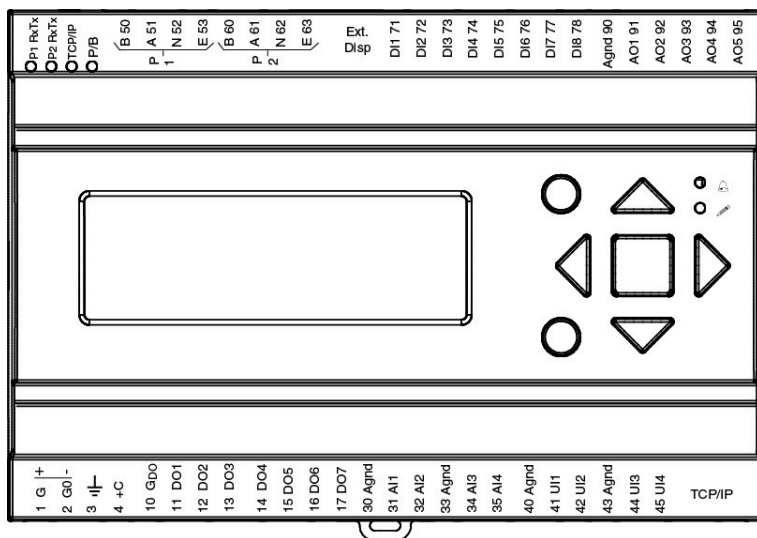

Terminal	I/O	Hardware model		Notes
		A15	A28	
1	Power supply G+	✓	✓	
2	Power supply G0-	✓	✓	
3	Earth	✓	✓	
4	DI common +C	✓	✓	
10	DO common GDO	✓	✓	
11	DO1	✓	✓	
12	DO2	✓	✓	
13	DO3	✓	✓	
14	DO4	✓	✓	
15	DO5	-	✓	
16	DO6	-	✓	
17	DO7	-	✓	
30	Analogue ground	✓	✓	
31	AI1	✓	✓	
32	AI2	✓	✓	
33	Analogue ground	✓	✓	
34	AI3	✓	✓	
35	AI4	✓	✓	
40	Analogue ground	✓	✓	
41	UAI1	-	✓	
42	UAI2	-	✓	
43	Analogue ground	✓	✓	
44	UAI3	-	✓	
45	UAI4	-	✓	
50	Port 1 B	✓*	✓*	
51	Port 1 A	✓*	✓*	
52	Port 1 N	✓*	✓*	
53	Port 1 E	✓*	✓*	

60	Port 2 B	✓*	✓*	
61	Port 2 A	✓*	✓*	
62	Port 2 N	✓*	✓*	
63	Port 2 E	✓*	✓*	
71	DI1	✓	✓	
72	DI2	✓	✓	
73	DI3	✓	✓	
74	DI4	✓	✓	
75	DI5	-	✓	
76	DI6	-	✓	
77	DI7	-	✓	
78	DI8	-	✓	
90	Analogue ground	✓	✓	
91	AO1	✓	✓	
92	AO2	✓	✓	
93	AO3	✓	✓	
94	AO4	-	✓	
95	AO5	-	✓	

* Depending on the model

E.2 Corrigo Vido (230 V models)

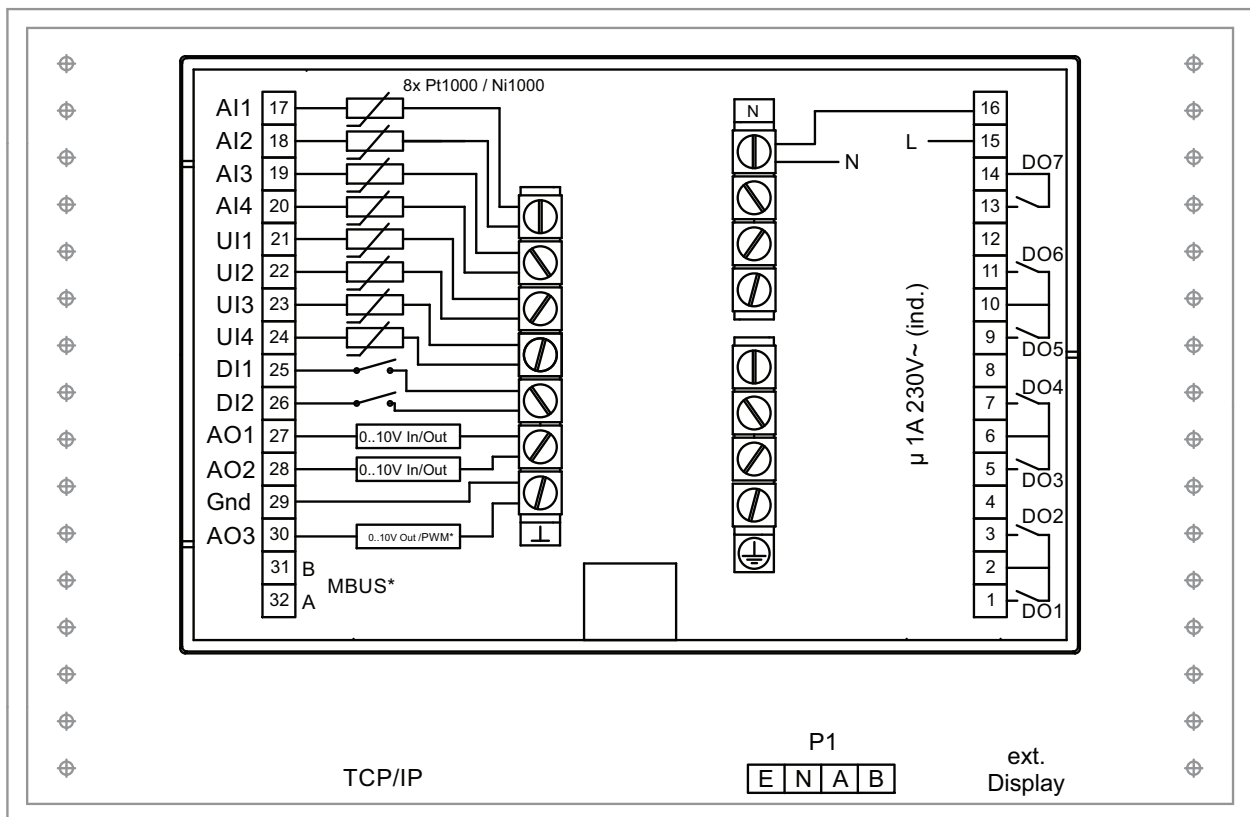

* Depending on the model

Terminal lists

Terminal	I/O	Hardware model		Note
		V19	V20	
1	DO1	✓	✓	
2	Common DO1/DO2	✓	✓	
3	DO2	✓	✓	
4	-	-	-	
5	DO3	✓	✓	
6	Common DO3/DO4	✓	✓	
7	DO4	✓	✓	
8	-	-	-	
9	DO5	✓	✓	
10	Common DO5/DO6	✓	✓	
11	DO6	✓	✓	
12	-	-	-	
13	DO7	✓	✓	
14	Common DO7	✓	✓	
15	Power supply L	✓	✓	
16	Power supply N	✓	✓	
17	AI1	✓	✓	
18	AI2	✓	✓	
19	AI3	✓	✓	
20	AI4	✓	✓	
21	UAI1	✓	✓	
22	UAI2	✓	✓	
23	UAI3	✓	✓	
24	UAI4	✓	✓	
25	DI1	✓	✓	
26	DI2	✓	✓	
27	UA1	✓	✓	
28	UA2	✓	✓	
29	Analogue ground	✓	✓	
30	AO3	-	✓	
31	MBUS A	✓*	✓	
32	MBUS B	✓*	✓	

* Depending on the model

Appendix F Frequency converters and EC controllers for heat exchangers

There is support for the following frequency converters and/or EC controllers:

- ✓ Vacon NXL
- ✓ Lenze
- ✓ Omron V1000
- ✓ Emerson Commander
- ✓ LS
- ✓ EBM-PAPST
- ✓ Danfoss FC 101
- ✓ ABB ACS
- ✓ Ziehl EC Blue

For Heat exchangers via Modbus:

- ✓ Eltwin A/S EC controller, RHC 200
- ✓ VariMax25
- ✓ OJ DRHX

When communicating via frequency converters through Modbus, it is sometimes necessary to change certain settings in the frequency converter.

F.1 Vacon NXL

No settings necessary. Vacon NXL frequency converters are controlled via Modbus. Communication, alarms and certain indications can be read:

The following signals can be read/written from/to the frequency converter:

Address	Modbus register	Name	Scaling	Type
2003	32003, 42003	FB speed reference (SP)	100	%
2001	32001, 42001	FB status word	-	Binary
2103	32103, 42103	FB motor speed	100	%
2105	32105, 42105	Motor speed	1	± Rpm
2106	32106, 42106	Current	100	A
2107	32107, 42107	Torque	10	± % (of nominal)
2110	32110, 42110	Voltage DC	1	V
2101	32101, 42101	FB status word	-	Binary

The variables presented in the display of the Corrigo are:

- ✓ Frequency (Hz)
- ✓ Output (kW)
- ✓ Current (A)
- ✓ Accumulated power (kWh)

F.2 Lenze

No settings necessary. Lenze frequency converters are controlled via Modbus. Communication, alarms and certain indications can be read.

The following signals can be read/written from/to the frequency converter:

Address	Modbus register	Name	Scaling	Type
49	32049, 42049	Password	-	-
50	32050, 42050	Parameter version	-	-
45	30045, 40045	FB speed reference (SP)	50	%
2	30002, 40002	FB status word	-	Binary
512	32512, 42512	Acc. motor output	1	kW
528	32528, 42528	Motor frequency	10	Hz
509	32509, 42509	Current	1	A
511	32511, 42511	Output	1000	kW
506	31506, 41506	Voltage DC	1	V
30	32110, 42110	Alarm	-	Error code
27	32027, 42027	FB status word	-	Binary

The variables presented in the display of the Corrigo are:

- ✓ Frequency (Hz)
- ✓ Output (kW)
- ✓ Current (A)
- ✓ Accumulated power (kWh)

F.3 Omron V1000

Connection via RS485:

Omron V1000		Corrigo
R+	connected to	S+
R-	connected to	S-
R+ / S+	connected to	B on Port 1 or Port 2
R- / S-	connected to	A on Port 1 or Port 2

F.3.1 Parameters

The following parameters must be set from the display of the frequency converter:

Parameter	Description	Set to value	Value
H5-01 (0 x 425)	Slave address	1	Supply air fan
		2	Exhaust air fan
H5-07 (0 x 42B)	RTS control	1 (enabled)	Activation of RS485
o1-03 (0 x 502)	Frequency reference units	1	0 - 100 %
H5-03 (0 x 427)	Parity	0	No parity

Default values should be used for remaining parameters. The following values may not be changed:

Parameter	Description	Set to	Value
H5-02 (0 x 426)	Communication speed	3 (default)	9600
H5-04 (0 x 428)	Stopping method after communication error	3 (default)	No stop
H5-11 (0 x 43C)	Communication Enter function	1 (default)	Enter command not necessary
H5-12 (0 x 43D)	Run command	0 (default)	bit 0 = forward start/stop, bit 1 = reverse start/stop
b1-01 (0 x 180)	Frequency reference selection 1	2 (default)	Via Modbus
b2-01 (0 x 181)	Run command selection 1	2 (default)	Via Modbus

Omron frequency converters are controlled via Modbus. Communication, alarms and certain indications can be read.

The following signals can be read/written from/to the frequency converter:

Address	Modbus register	Name	Scaling	Type
3	30003, 40003	FB Speed reference (SP)	10	%
2	30002, 40002	Password	-	-
36	30036, 40036	Motor frequency	100	Hz
63	30063, 40063	Motor speed	1	± Rpm
39	30039, 40039	Current	10	A
40	30040, 40040	Output	1	kW
38	30038, 40038	DC voltage	10	V
33	30033, 40033	Status change	-	Binary
34	30034, 40034	Alarm	-	Binary
93	30093, 40093	Acc. Motor output	1	kW

The variables presented in the display of the Corrigo are:

- ✓ Frequency (Hz)
- ✓ Output (kW)
- ✓ Current (A)
- ✓ Accumulated power (kWh)

F.4 Emerson Commander

Connection between RS485 and RJ45:

RJ45	connected to
2 (orange)	B on Port 1 or Port 2
7 (white/brown)	A on Port 1 or Port 2

F.4.1 Termination resistor

- ✓ If using a termination resistor, it should be connected between RJ45:1 (white/orange) and RJ45:8 (brown).



Note! If Modbus communication is not initialised after powering up, disconnect the termination resistor and try again.

F.4.2 Terminals

Terminal	Description	Corrigo
B4	Drive enabled	B2 (+ 24 V)
B5	Forward	B2 (+ 24 V)

F.4.3 Parameters

The following parameters must be set from the display of the frequency converter:

Parameter	Description	Set to value	Value
44	Slave address	1 (default)	Supply air fan
		2	Exhaust air fan
43	Baud rate	9.6 (Default is 19.2)	



Note! Default values should be used for remaining parameters

F.4.4 Changing parameters

1. Deactivate the unit by opening terminal B4. The display should read "iH 0.0".
2. Set parameter 10 to L3. All parameters up to and including 95 can then be altered.
3. Set parameter 43 to 9.6 (9600 Baud)

Emerson frequency converters are controlled via Modbus. Communication, alarms and certain indications can be read.

The following signals can be read/written from/to the frequency converter:

Address	Modbus register	Name	Scaling	Type
114	30114, 40114	Speed selection	-	-
18	30018, 40018	FB speed reference (SP)	10	%
1038	31038, 41038	FB status word	-	-
615	30615, 40615	Control switch	-	Binary
501	30501, 40501	Motor frequency	10	Hz
2	30002, 40002	Max speed	10	Hz
504	30504, 40504	Motor speed	1	+/- Rpm
402	30402, 40402	Current	100	A
503	30503, 40503	Output	100	kW
505	30505, 40505	Voltage DC	1	V
1040	31040 41040	Status change	-	Binary

The variables presented in the display of the Corrigo are:

- ✓ Frequency (Hz)
- ✓ Output (kW)
- ✓ Current (A)
- ✓ Accumulated power (kWh)

F.5 LS

LS frequency converters are controlled via Modbus. Communication, alarms and certain indications can be read.

F.5.1 LS iG5A

The following signals can be read/written from/to the frequency converter:

Address	Modbus register	Name	Scaling	Type
5	30005,40005	FB speed reference (SP)	10	%
6	30006,40006	FB status word	-	Binary
10	30010,40010	Motor frequency	100	Hz
31	30031,40031	Torque	100	%
21	30029,40029	RPM	1	Rpm
9	30009,40009	Motor current	10	A
13	30013,40013	Output	10	kW
12	30012,40012	Voltage	10	V
14	30014,40014	Status change	-	Binary

The variables presented in the display of the Corrigo are:

- ✓ Frequency (Hz)
- ✓ Output (kW)
- ✓ Current (A)
- ✓ Accumulated power (kWh)

F.5.2 LS iS7

The following signals can be read/written from/to the frequency converter:

Address	Modbus register	Name	Scaling	Type
5	30005,40005	FB speed reference (SP)	100	%
6	30006,40006	FB status word	-	Binary
10	30010,40010	Motor frequency	100	Hz
791	30791,40791	Torque	10	%
786	30786,40786	RPM	1	Rpm
784	30784,40784	Motor current	10	A
790	30790,40790	Output	10	kW
789	30789,40789	Voltage	10	V
14	30014,40014	Status change	-	Binary

The variables presented in the display of the Corrigo are:

- ✓ Frequency (Hz)
- ✓ Output (kW)
- ✓ Current (A)
- ✓ Accumulated power (kWh)

F.6 EBM-PAPST

EBM frequency converters are controlled via Modbus. Communication, alarms and certain indications can be read.

The following signals can be read/written from/to the frequency converter:

Address	Modbus register	Name	Scaling	Type
53250	353250, 453250	FB speed reference (SP)	640	%
53249	353249, 453249	FB control word	-	
53265	353265, 453265	RPM	1	Rpm
53266	353226, 453266	FB status word	-	Binary
53267	353267, 453267	Status change		Binary
53268	353268, 453268	DC voltage	1	V
53269	353269, 453269	Motor current	1	A
53282	353282, 453282	Output	1000	kW
53665	353665, 453665	Voltage current max value	1	V or A
53530	353530, 453530	Rpm max value	1	Rpm

The variables presented in the display of the Corrigo are:

- ✓ Frequency (Hz)
- ✓ Output (kW)
- ✓ Current (A)
- ✓ Accumulated power (kWh)

F.7 Ziehl EC Blue

ECBlue frequency converters are controlled via Modbus. Communication, alarms and certain indications can be read.

The following signals can be read/written from/to the frequency converter:

Address	Modbus register	Name	Scaling	Type
3	30003,40003	FB speed reference (SP)	1	%
2	30002,40002	FB control word	-	0 = off 3 = on
15	30015,40015	RPM	1	Rpm
16	30016,40016	Current	100	A
34	30034,40034	Output	1000	kW
21	30021,40021	DC voltage	1	V
13	30013,40013	Alarm	-	Error code

The variables presented in the display of the Corrigo are:

- ✓ Frequency (Hz)
- ✓ Output (kW)
- ✓ Current (A)
- ✓ Accumulated power (kWh)

F.8 Danfoss FC 101

Danfoss frequency converters are controlled via Modbus. Communication, alarms and certain indications can be read.

The following signals can be read/written from/to the frequency converter:

Address	Modbus register	Name	Scaling	Type
2811	32811, 42811	FB speed reference (SP)	1	%
2810	32810, 42810	FB control word	-	
16130	316130,416130	Motor frequency	10	Hz
16140	316140,416140	Current	100	A
16100	316100,416100	Output	1000	kW
16300	316300,416300	DC voltage	1	V
16030	316030,416030	Status change	-	

The variables presented in the display of the Corrigo are:

- ✓ Frequency (Hz)
- ✓ Output (kW)
- ✓ Current (A)
- ✓ Accumulated power (kWh)

F.9 F.XX, ABB

Address	Modbus register	Name	Scaling	Type
3	30003, 40003	FB speed reference (SP)	100	%
31	30031, 40031	FB control word	-	
103	30103, 40103	Motor frequency	10	Hz
104	30104, 40104	Current	10	A
106	30106, 40106	Output	0.01	kW
107	30107, 40107	DC voltage	1	V
33	30033, 40033	Status change	-	Binary
34	30034, 40034	Active fault byte	-	Binary

F.10 Eltwin A/S EC controller (for heat exchangers), RHC 200

Communication takes place using address 7, 9600 bps, 8 bits, no parity and 1 stop bit.

Version 1.01, 2015-04-03

Address	Modbus register	Name	Scaling	Type
2	30002	Running mode	-	Bit 0 = Operation0: Stop1: Run Bit 3 = Reset1: Reset
5	30005	Error code	1	Bit 0: Excess current/ Ground fault Bit 1: Excess current from DC link 265V~ Bit 2: Undervoltage from DC link 170V~ Bit 3: Hardware error Bit 4: External error, input Bit 5: Overload Bit 6: Overheating, stop Bit 7: Overheating, reduced Bit 8: Rotor cover error Bit 9: Rotor cover input Bit 10: DIP 1 Bit 11: DIP 2 Bit 12: DIP 3 Bit 13: DIP 4 Bit 14: Not used Bit 15: Communication error

F.11 VariMax25M

Communication takes place using address 16, 9600 bps, 8 bits, no parity and 1 stop bit.

Address	Modbus register	Name	Scaling	Type
1	30001	Setpoint	10	0...100.0 %
1	10001	Alarm acknowledgement		1
12	30012	Error status	-	

F.12 F.XX, OJ DRHX

Address	Modbus register	Name	Scaling	Type
1	10001	Motor On/Off	-	Binary
2	10002	Reset alarm	-	Binary
8	10008	Control mode	-	Binary
1	20001	Rotorguard alarm	-	Binary
2	20002	VLO alarm	-	Binary
3	20003	VHI alarm	-	Binary
4	20004	IHI alarm	-	Binary
11	20011	Internal stop alarm	-	Binary
12	20012	Rotor blocked alarm	-	Binary
19	20019	Ext 24V supply overload alarm	-	Binary
1	40001	Setpoint	1	0...100%

F.13 Mitsubishi Heavy (for DX split)

Address	Modbus register	Name	Scaling	Type
0	1	AC unit On/Off	-	R/W ✓ 0: Off ✓ 1: On
1	2	AC unit mode	-	R/W ✓ 1: Heat ✓ 4: Cool
4	5	AC unit temperature setpoint ^{2,3,4} ✓ -32768 (Initialization value)	1	R/W °C °F All modes (except heat) ✓ 18...30°C (°C/x10°C) ✓ 64...86°F Heat ✓ 16...30°C ✓ 61...61°F
10	11	AC unit alarm status	-	R ✓ 0: No alarm condition ✓ 1: Alarm condition
31	32	Status (feedback)	-	R ✓ 0: Not active (Default value) ✓ 1: Active (A window is open)
45	46	Error reset	-	W ✓ 1: Reset



HEAD OFFICE AB Regin, Box 116, SE-428 22 Källered • Visiting address: Bangårdsvägen 35, SE-428 36 Källered
Phone: +46 (0)31 720 02 00 • Fax: +46 (0)31 720 02 50 • info@regincontrols.com • www.regincontrols.com