



INSTRUCTION MTIC



Read this instruction before installation and wiring of the product

12970C
OCT 22



Consult documentation in all cases where this symbol is used, in order to find out the nature of the potential hazards and any actions to be taken

Mechanical capillary thermostat

MTIC is a series of high quality electro-mechanical thermostats for use in cooling, heating and ventilation systems.

Technical data

Sensor element	Liquid-filled copper bulb
Contacts	Dust-tight microswitches with SPDT contacts (heat/cool)
Bulb dimensions	Ø9.5 (Ø8 for range 50...120°C)
Capillary length	1.5m
Switch capacity	15 (8) A, 24...250 V AC
Ambient temperature	-35...+65°C
Ambient humidity	10...90 % RH (non-condensing)
Housing	Bayblend® base, ABS cover
Protection class	IP65
Isolation class	1
Weight	400 g
Storage temperature	-40...+70°C
Storage humidity	up to 95% RH

Article	Temperature range	Steps	Step diff. max	Hysteresis
MTIC30S	-30...+30°C	1		2...20 K
MTIC30SH	-30...+30°C	1		2...20 K
MTIC30-2	-30...+30°C	2	2...5 K	1K
MTIC30	-30...+30°C	1		1K
MTIC30R	-30...+30°C	1		Manual min. reset
MTIC90S	20...+90°C	1		2...20 K
MTIC90SH	20...+90°C	1		2...20 K
MTIC90	20...+90°C	1		1 K
MTIC90R	20...+90°C	1		Manual max. reset
MTIC120S	50...120°C	1		2...20K

Article	Max. bulb temp	Suitable immersion well	Hidden setpoint
MTIC30S	60°C	DR-01/02	
MTIC30SH	60°C	DR-01/02	*
MTIC30-2	60°C	DR-01/02	
MTIC30	60°C	DR-01/02	
MTIC30R	60°C	DR-01/02	
MTIC90S	100°C	DR-01/02	
MTIC90SH	100°C	DR-01/02	*
MTIC90	100°C	DR-01/02	
MTIC90R	100°C	DR-01/02	
MTIC120S	150°C	DR-16/17	



Before installation or maintenance, the power supply must first be disconnected in order to prevent potentially lethal electric shocks! Installation or maintenance of this unit should only be carried out by skilled professionals.

Installation

The unit can be mounted in any position.

Remove the external knob and unscrew both screws on the cover. Use the supplied screws when mounting on wall or other surface.

Wiring

1-step models

Heating:

Connect to the red and blue terminal. The contact will open when the temperature rises.

Cooling:

Connect to the red and white terminal. The contact will open when the temperature drops.

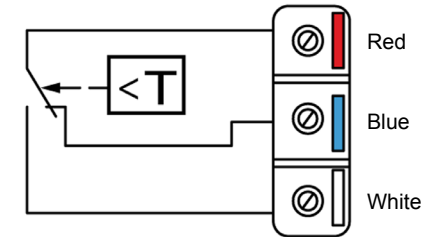

2-step models

Heating:

Connect to the red and blue terminal. The contact will open when the temperature rises. The step 2 contact will open first followed by the step 1 contact.

Cooling:

Connect to the red and white terminal. The contact will open when the temperature drops. The step 2 contact will open first when the temperature drops, followed by the step 1 contact.

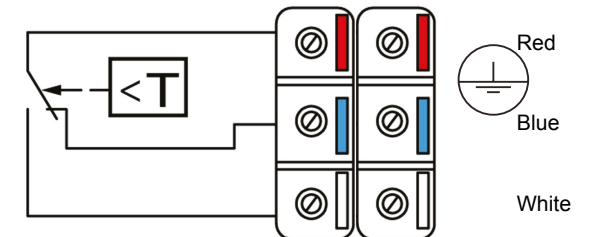

Logic activation single-stage model:

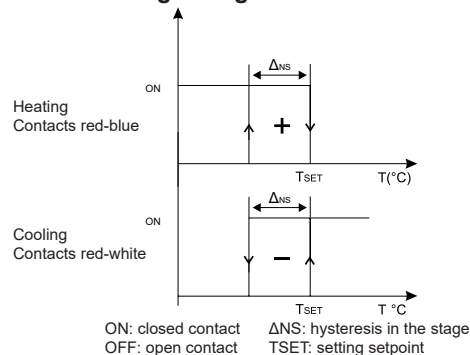

Logic activation two-stage model:

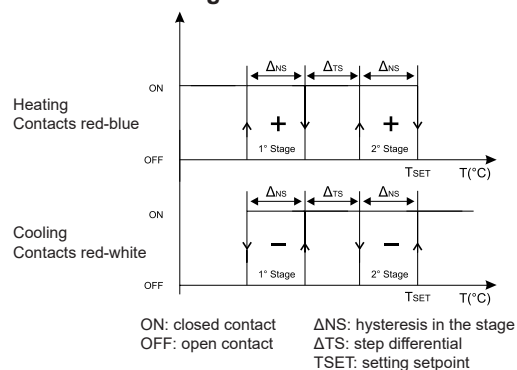

Hysteresis adjustment in the stage:

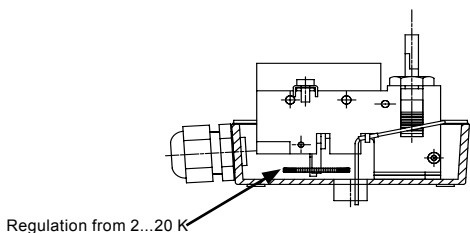

Step differential adjustment:

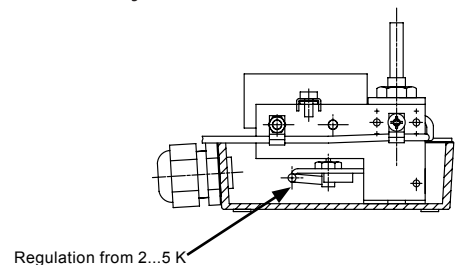

Reset

The set range may be reset by carefully turning screw under the cover.

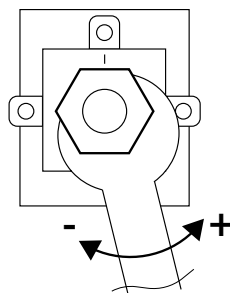

Low Voltage Directive (LVD) standards

This product conforms to the requirements of the European Low Voltage Directive (LVD) 2014/35/EU through product standards EN 60335-1.

RoHS

This product conforms to the Directive 2011/65/EU of the European Parliament and of the Council through standard EN 50581:2012.

Contact

AB Regin, Box 116, 428 22 Kålleröd, Sweden
Tel: +46 31 720 02 00, Fax: +46 31 720 02 50
www.regincontrols.com, info@regincontrols.com



INSTRUKTION MTIC



Läs denna instruktion innan produkten monteras och ansluts



Följ alltid de anvisade säkerhetsföreskrifterna i dokumentationen för att förebygga risken för brand, elstöt och personskador

Mekanisk dykrörstermostat

MTIC är en serie högkvalitativa elektromekaniska dykrörstermostater för användning inom kyl-, värme- och ventilationssystem.

Tekniska data

Givarelement	Vätskefylld bulb i koppar
Kontakt	Dammtäta mikrobrytare med SPDT-kontakter (värme/kyla)
Bulbdimensioner	Ø9.5 (Ø8 för område +50...+120°C)
Kapillarlängd	1,5 m
Brytförmåga	15 (8) A, 24...250 V AC
Omgivningstemperatur	-35...+65 °C
Omgivande luftfuktighet	10...90 % RH (icke-kondenserande)
Givarhus	Bas i Bayblend®, lock i ABS
Skyddsklass	IP65
Isoleringsklass	1
Vikt	400 g
Förvaringstemperatur	-40...+70°C
Förvaringsluftfuktighet	upp till 95 % RH

Artikel	Temperaturområde	Steg	Max. steg-diff.	Hysteres
MTIC30S	-30...+30°C	1		2...20 K
MTIC30SH	-30...+30°C	1		2...20 K
MTIC30-2	-30...+30°C	2	2...5 K	1K
MTIC30	-30...+30°C	1		1K
MTIC30R	-30...+30°C	1		Manual min. reset
MTIC90S	20...+90°C	1		2...20 K
MTIC90SH	20...+90°C	1		2...20 K
MTIC90	20...+90°C	1		1 K
MTIC90R	20...+90°C	1		Manual max. reset
MTIC120S	50...120°C	1		2...20K

Artikel	Max. bulb-temp	Passande dyrkrör	Dolt börvärde
MTIC30S	60°C	DR-01/02	
MTIC30SH	60°C	DR-01/02	*
MTIC30-2	60°C	DR-01/02	
MTIC30	60°C	DR-01/02	
MTIC30R	60°C	DR-01/02	
MTIC90S	100°C	DR-01/02	
MTIC90SH	100°C	DR-01/02	*
MTIC90	100°C	DR-01/02	
MTIC90R	100°C	DR-01/02	
MTIC120S	150°C	DR-16/17	



Innan installation eller underhåll måste matningsspänningen först kopplas från för att undvika potentiell elstöt under pågående arbete! Installation eller underhåll av denna enhet ska endast utföras av kvalificerad personal.

Installation

Enheterna kan monteras i valfritt läge.

Ta bort den externa ratten och skruva ur de bägge skruvarna ur locket. Använd medföljande monteringskruvar för att montera enheten på vägg eller annan yta.

Inkoppling

Värme:

Anslut till den röda och blå plinten. Kontakten öppnar när temperaturen ökar.

Kyla:

Anslut till den vita och röda plinten. Kontakten öppnar när temperaturen minskar.

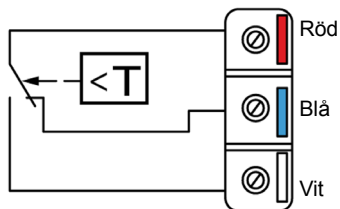

2-stegsmodeller

Värme:

Anslut till den röda och blå plinten. Kontakten öppnar när temperaturen ökar. Kontakten till steg 2 öppnar först och följs av kontakten till steg 1.

Kyla:

Anslut till den vita och röda plinten. Kontakten öppnar när temperaturen minskar. Kontakten till steg 2 öppnar först och följs av kontakten till steg 1.

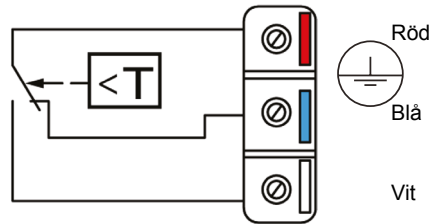

Logisk aktivering enstegsmodell:

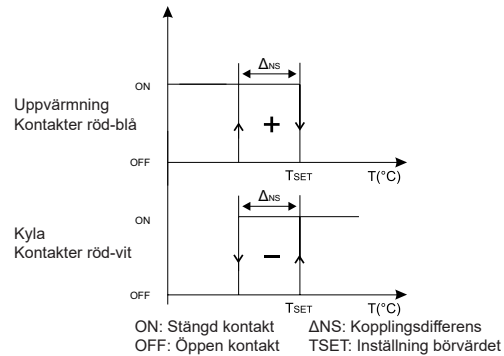

Logisk aktivering tvåstegsmodell:

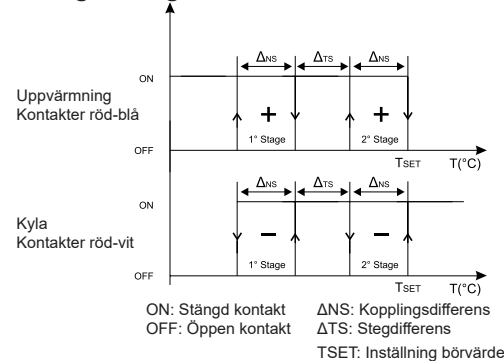

MTIC

Hysteres justering:

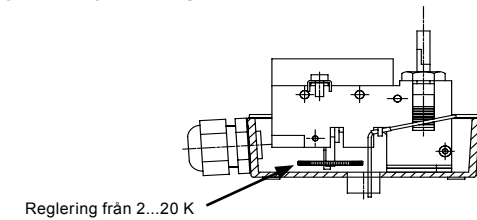

Stegdifferens justering:

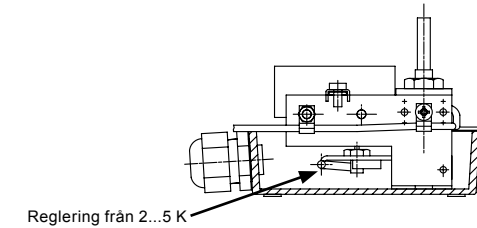

Återställning

Inställt område kan återställas genom att försiktigt vrida på skruven under locket.

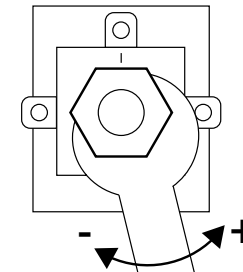

LVD, lågspänningsdirektivet

Produkten uppfyller kraven i det europeiska lågspänningsdirektivet (LVD) 2014/35/EU genom produktstandard EN 60335-1.

RoHS

Produkten uppfyller Europaparlamentets och rådets direktiv 2011/65/EU genom standard EN 50581:2012.

Teknisk support

Teknisk hjälp och råd på telefon: 031 720 02 30

Kontakt

AB Regin, Box 116, 428 22 Källered

Tel: +46 31 720 02 00, Fax: +46 31 720 02 50

www.regincontrols.com, info@regincontrols.com



ANLEITUNG MTIC



Lesen Sie diese Anleitung bitte vor der Installation und Verkabelung des Produkts. Änderungen vorbehalten.



Beachten Sie bitte stets die Sicherheitshinweise in der Dokumentation, um die Gefahr von Bränden, Stromschlägen und Verletzungen zu vermeiden.

Mechanischer Kapillarthermostat

MTIC ist eine Serie qualitativ hochwertiger elektromechanischer Thermostate für den Einsatz in Kühl-, Heiz- und Lüftungsanlagen.

Technische Daten

Sensorelement	Mit Flüssigkeit gefüllter Kupferkolben
Kontakte	Staubdichte Mikroschalter mit SPDT-Kontakten (Heizen/Kühlen)
Fühlerstab	ø 9,5 mm (ø 8 mm für den Bereich 50...120 °C)
Länge, Kapillarrohr	1,5 m
Schaltleistung	15 (8) A, 24...250 V AC
Umgebungstemperatur	-30...+65 °C
Umgebungsfeuchte	10...90 % RH, nicht kondensierend
Gehäuse	Bayblend®-Basis, ABS-Abdeckung
Schutzart	IP65
Isolationsklasse	1
Gewicht	400 g
Lagertemperatur	-40...+70 °C
Lagerfeuchte	bis zu 95 % RH

Artikel	Temperaturbereich	Stufen	Stufen-differenz	Hysterese
MTIC30S	-30...+30 °C	1		2...20 K
MTIC30SH	-30...+30 °C	1		2...20 K
MTIC30-2	-30...+30 °C	2	2...5 K	1 K
MTIC30	-30...+30 °C	1		1 K
MTIC30R	-30...+30 °C	1		Manuelles Zurücksetzen (Min.)
MTIC90S	20...+90 °C	1		2...20 K
MTIC90SH	20...+90 °C	1		2...20 K
MTIC90	20...+90 °C	1		1 K
MTIC90R	20...+90 °C	1		Manuelles Zurücksetzen (Max.)
MTIC120S	50...120 °C	1		2...20 K

Artikel	Max. Fühler-temperatur	Passende Schutz-hülse	versteckter Sollwert
MTIC30S	60 °C	DR-01/02	
MTIC30SH	60 °C	DR-01/02	*
MTIC30-2	60 °C	DR-01/02	
MTIC30	60 °C	DR-01/02	
MTIC30R	60 °C	DR-01/02	
MTIC90S	100 °C	DR-01/02	
MTIC90SH	100 °C	DR-01/02	*
MTIC90	100 °C	DR-01/02	
MTIC90R	100 °C	DR-01/02	
MTIC120S	150 °C	DR-16/17	



Vor der Installation oder Wartung muss zuerst die Stromversorgung unterbrochen werden, um lebensgefährliche Stromschläge zu vermeiden! Die Installation oder Wartung dieses Geräts sollte nur von qualifizierten Fachkräften durchgeführt werden.

Installation

Das Gerät kann in jeder Position montiert werden.

Entfernen Sie den äußeren Drehknopf und lösen Sie die beiden Schrauben am Deckel. Verwenden Sie bei der Montage an der Wand oder einer anderen Oberfläche die mitgelieferten Schrauben.

Verdrahtung

1-stufige Modelle

Heizen:

Anschluss an die rote und blaue Klemme. Der Kontakt öffnet, wenn die Temperatur ansteigt.

Kühlen:

Anschluss an die rote und weiße Klemme. Der Kontakt öffnet, wenn die Temperatur sinkt.

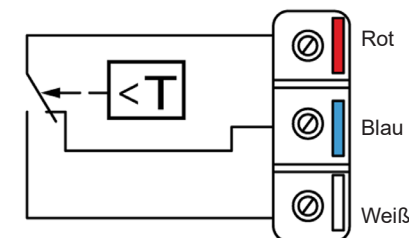

2-stufige Modelle

Heizen:

Anschluss an die rote und blaue Klemme. Der Kontakt öffnet, wenn die Temperatur ansteigt. Der Kontakt Stufe 2 öffnet zuerst, gefolgt vom Kontakt Stufe 1.

Kühlen:

Anschluss an die rote und weiße Klemme. Der Kontakt öffnet, wenn die Temperatur sinkt. Der Kontakt Stufe 2 öffnet zuerst, wenn die Temperatur sinkt, gefolgt vom Kontakt Stufe 1.

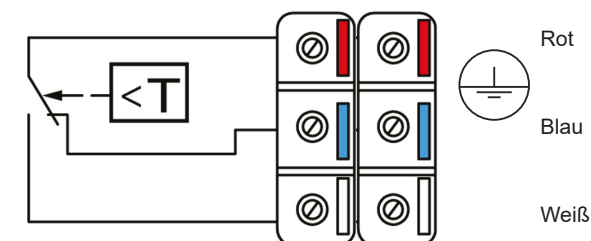

Logik-Aktivierung 1-stufiges Modell

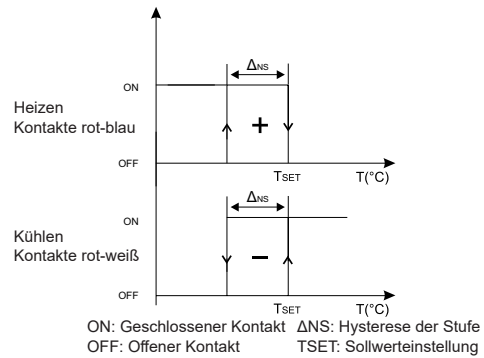

Logik-Aktivierung 2-stufiges Modell

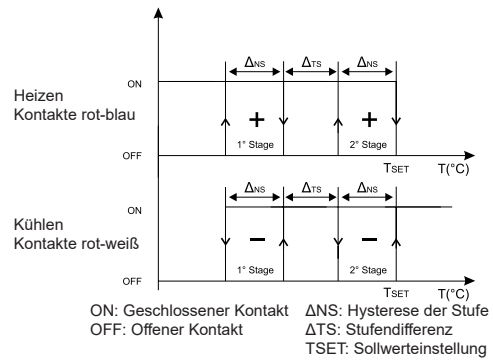

Einstellung Hysterese der Stufe:

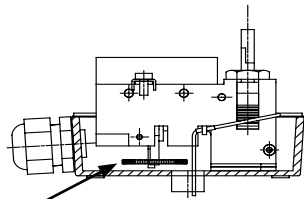

Regulierung von 2...20 K

Einstellung Stufendifferenz:

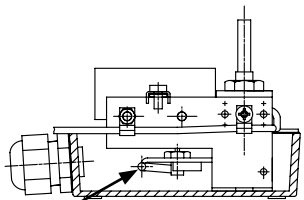

Regulierung von 2...5 K

Zurücksetzen

Der eingestellte Bereich kann durch vorsichtiges Drehen der Schraube unter dem Deckel zurückgesetzt werden.

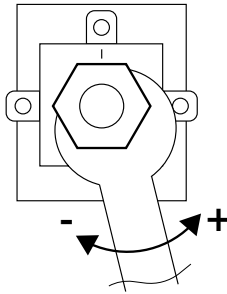

Niederspannungsrichtlinie (LVD)

Dieses Produkt entspricht den Anforderungen der Niederspannungsrichtlinie (LVD) 2014/35/EU durch Erfüllung der Norm EN 60335-1.

RoHS

Dieses Produkt entspricht den Anforderungen der Richtlinie 2011/65/EU des Europäischen Parlaments und des Rates durch EN 50581:2012.

Kontakt

Regin Controls Deutschland GmbH, Haynauer Str. 49, 12249 Berlin
 Telefon: +49 30 77994-0, Fax: +49 30 77994-79
www.regincontrols.de, info@regincontrols.de